

R890 Diverter Rough valve shown with Colony Soft T990.500 trim kit

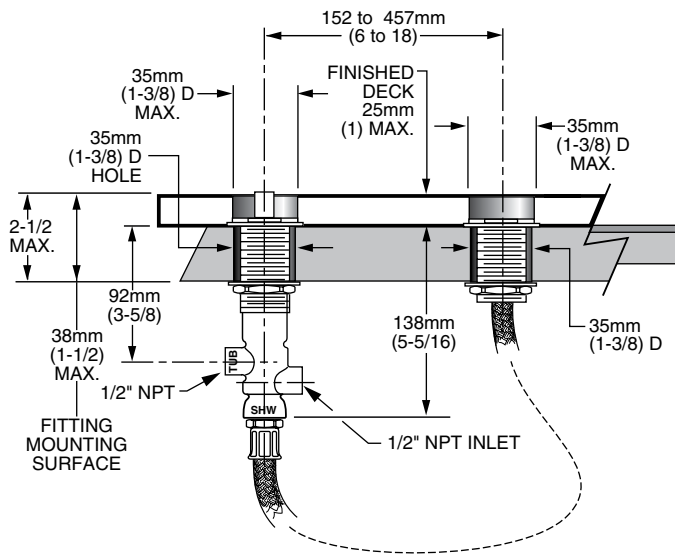

GENERAL DESCRIPTION:

Durable cast brass construction. 1/2" N.P.T. inlets and outlets. Adjustable total rough-in up to 2-1/2" max., 1-1/2" for rough deck, and 1" additional for finished deck. Diverter valve only (not an On/Off valve) must be installed with separate Deck Mount Tub Filler Valve. All personal showers with 2.5GPM/9.5L/min. max. flow.

SUGGESTED SPECIFICATION:

Deck-mount tub filler diverter valve shall feature cast brass construction and an adjustable rough-in up to 2-1/2". Fitting shall be American Standard Model # R890 Trim kit # _____.

MODEL NUMBER:

- R890 Diverter and Personal Rough Valve**
Rough valve only.
- T990.500 Colony Soft Trim Kit**
Lever Diverter handle, Personal Shower and holder. LESS valve.
- T508.990 Princeton Trim Kit**
Metal Lever Diverter handle, Personal Shower and holder. LESS valve.
- T038.990 Tropic Trim Kit**
Metal Lever Diverter handle, Personal Shower and holder. LESS valve.
- T028.990 Dazzle Trim Kit**
Metal Lever Diverter handle, Personal Shower and holder. LESS valve.
- T991.712 Hampton Trim Kit**
Porcelain Lever Diverter handle, Personal Shower and holder. LESS valve.
- T991.722 Hampton Trim Kit**
Metal Cross Diverter handle, Personal Shower and holder. LESS valve.
- T991.732 Hampton Trim Kit**
Metal Lever Diverter handle, Personal Shower and holder. LESS valve.

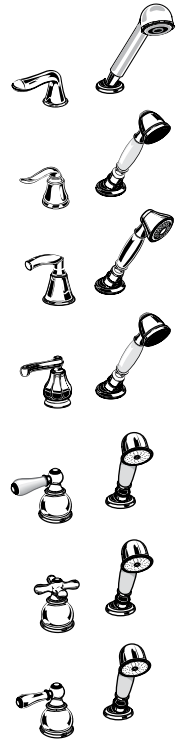

PRODUCT FEATURES:

Brass Construction: Ideal for prolonged contact with water.

Many trim options: Wide range of styles.













Choice of Finishes: Wide range of durable finishes.

CODES AND STANDARDS

These products meet or exceed the following codes and standards:

**ASME A112.18.1
CSA B 125**

Check local plumbing codes. Some installations may require a vacuum breaker.

	Product Number	Description	Finish Options						
			Polished Chrome	PVD Blackened Bronze	PVD Polished Brass	Satin (PVD)/ Chrome mix.	(PVD) Satin Nickel	Satin/ Brass (PVD) mix.	Chr/Brass (PVD) mix.
			002	068	099	221	295	297	299
	R890	Rough valve only.	N/A	N/A	N/A	N/A	N/A	N/A	N/A
	 T990.500	Lever Diverter handle. Personal shower and holder. Less valve.		N/A	N/A	N/A		N/A	N/A
	 T508.990	Metal Lever Diverter handle. Personal shower and holder. Less valve.			N/A	N/A		N/A	N/A
	 T038.990	Metal Lever Diverter handle. Personal shower and holder. Less valve.		N/A	N/A	N/A		N/A	N/A
	 T028.990	Metal Lever Diverter handle. Personal shower and holder. Less valve.			N/A	N/A		N/A	N/A
	 T991.712	Porcelain Lever Diverter handle. Personal shower and holder. Less valve.		N/A		N/A		N/A	N/A
	 T991.722	Metal Cross Diverter handle. Personal shower and holder. Less valve.		N/A		N/A		N/A	N/A
	 T991.732	Metal Lever Diverter handle. Personal shower and holder. Less valve.							

N/A = NOT AVAILABLE

 Meets the American Disabilities Act Guidelines and **ANSI A117.1** Requirements for the physically challenged.