

TRANSITIONS AND DAMPERS

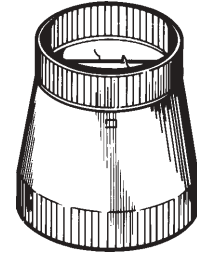

Model 411 Transition

- 3¼" x 10" to 6" round

Model 412H Transition

- 3¼" x 10" to 7" round

Model 413 Transition

- 3¼" x 10" to 8" round

All models above -
30 GA galvanized steel
construction

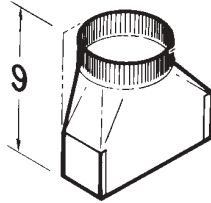

Model 424 Transition

- 4½" x 18½" to 10" round
horizontal, rear
discharge

- 26 GA galvanized steel
construction
- For use with Model 422
rough-in kit and Model
323 barbeque blower
system and 332K with
331/332 Remote Blower
and Model 326 Interior
Blower

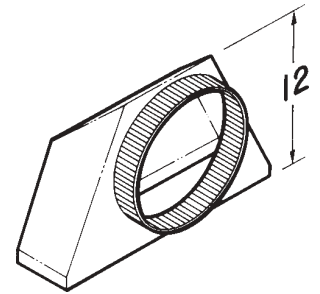

Model 414 Transition

- 10" round to 8" round
- 24 GA galvanized steel

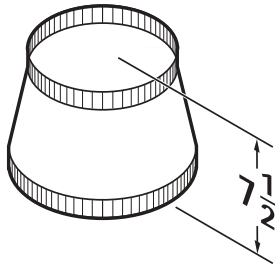

Model 453 Transition

- 4½" x 18½" to 10" round
horizontal, left
discharge

- 26 GA galvanized
steel construction
- For use with Model
422 rough-in kit
and Model 323
barbeque blower
system and 332K
with 331/332
Remote Blower
and Model 326
Interior Blower

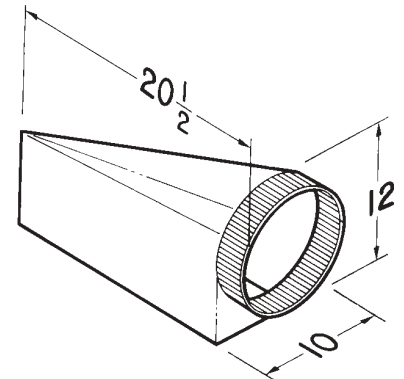

Model 423 Transition

- 4½" x 18½" to 10" round
- vertical discharge
- 26 GA galvanized steel
construction
- For use with Model 422
rough-in kit and Model
323 barbeque blower
system or 332K with
331/332 Remote Blower
or Model 326 Interior
Blower

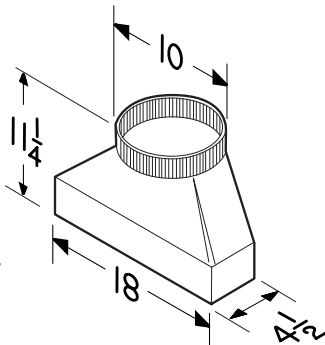

Model 454 Transition

- Same as Model
453 except -
horizontal right
discharge

Broan-NuTone LLC, 926 West State Street, Hartford, WI 53027 (1-800-637-1453)

NuTone, Inc., 4820 Red Bank Road, Cincinnati, OH 45227 (1-800-543-8687)

Broan-NuTone Canada, Inc., 1140 Tristar Drive, Mississauga, Ontario, L5T 1H9 (1-888-882-7626)

REFERENCE	QTY.	REMARKS	Project
			Location
			Architect
			Engineer
			Contractor
			Submitted by Date

Model 459 Transition

- 3 1/4" x 14" to 8" round - vertical discharge
- 30 GA galvanized steel construction

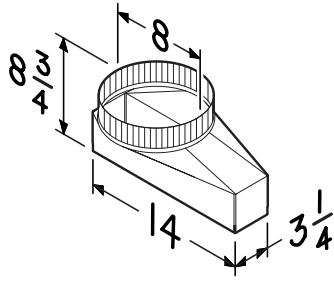

Model T460 Transition

- 3 1/4" x 14" to 7" round - vertical discharge
- 30 GA galvanized steel construction

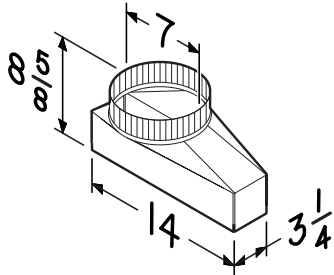

Model T462 Transition

- 3 1/4" x 14" to 6" round - vertical discharge
- 30 GA galvanized steel construction

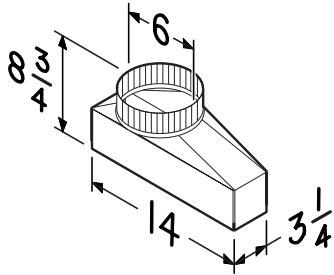

Model 472 Transition / Damper

- 10" round to 8" round
- Spring-loaded aluminum louvers
- Rubber stops
- 24 GA galvanized steel

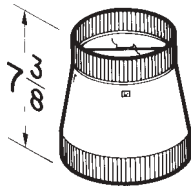

Model 475 Transition

- 6" round to 4" round
- Black, polymeric construction

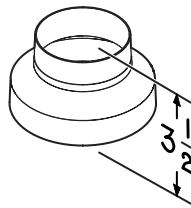

Model 475B Transition

- Six-pack of Model 475

Model T81212 Transition

- 8" x 12" to 12" round
- 28 ga. galvanized steel

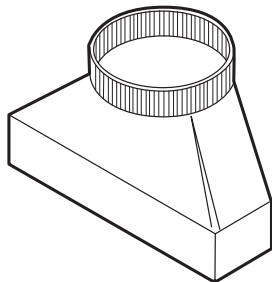

Model S99610015 Transition

- 8" x 12" to 10" round - vertical discharge
- 26 GA galvanized steel construction

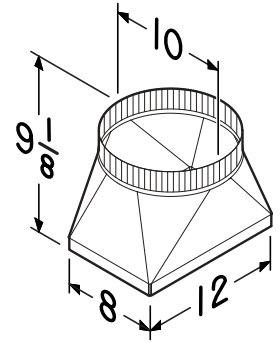

Model BP87 Damper

- 7" round
- Extruded steel with electrically-bonded epoxy finish
- .016 Aluminum louvers
- For use with 42000 range hood

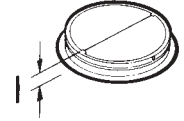

Model 97 Damper

- 7" round
- 28 GA galvanized steel
- Aluminum louvers

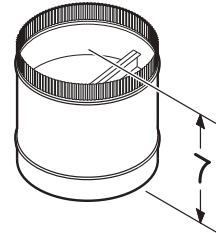

Model 99 Damper

- 9" round
- .032 All Aluminum construction
- Spring-loaded aluminum louvers

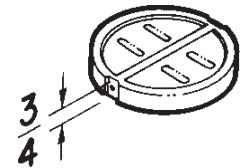

Model 421 Damper

- 10" round
- 24 GA galvanized steel with aluminum louvers

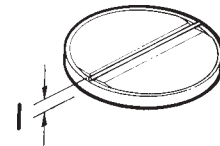

Model 438 Damper

- 8" round
- 24 GA galvanized steel with aluminum louvers

