

# TRANSITIONS AND DAMPERS

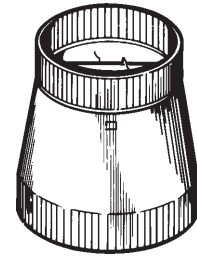

## TRANSITIONS

### Model 411

- 3¼" x 10" to 6" round

### Model 412H

- 3¼" x 10" to 7" round

### Model 413

- 3¼" x 10" to 8" round

All models above -  
30 GA galvanized steel  
construction

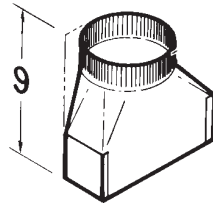

### Model 423

- 4½" x 18½" to 10" round - vertical discharge
- 26 GA galvanized steel construction
- For use with Model 422 rough-in kit and Model 323 barbeque blower system or 332K with 331/332 Remote Blower or Model 326 Interior Blower

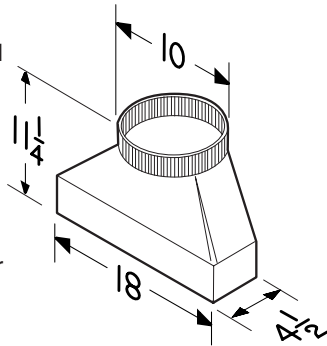

### Model 424

- 4½" x 18½" to 10" round horizontal, rear discharge
- 26 GA galvanized steel construction
- For use with Model 422 rough-in kit and Model 323 barbeque blower system and 332K with 331/332 Remote Blower and Model 326 Interior Blower

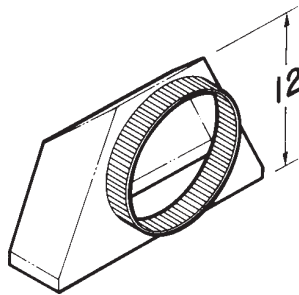

### Model 453

- 4½" x 18½" to 10" round horizontal, left discharge
- 26 GA galvanized steel construction
- For use with Model 422 rough-in kit and Model 323 barbeque blower system and 332K with 331/332 Remote Blower and Model 326 Interior Blower

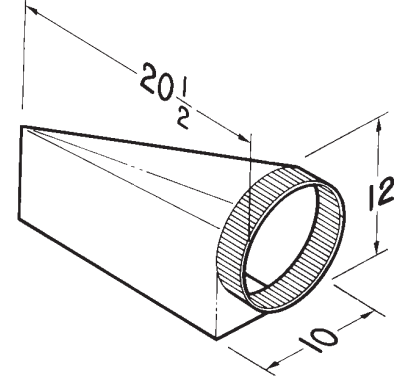

### Model 454

- Same as Model 453 except - horizontal right discharge

### Model 459

- 3¼" x 14" to 8" round - vertical discharge
- 30 GA galvanized steel construction
- For use with Dowlndraft Exterior Blower Systems.

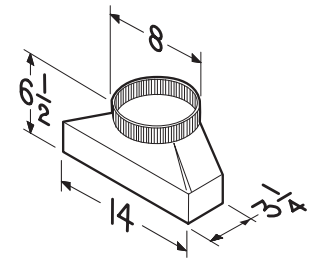

**Broan-NuTone LLC**, 926 West State Street, Hartford, WI 53027 (1-800-637-1453)

**NuTone, Inc.**, 4820 Red Bank Road, Cincinnati, OH 45227 (1-800-543-8687)

**Broan-NuTone Canada, Inc.**, 1140 Tristar Drive, Mississauga, Ontario, L5T 1H9 (1-888-882-7626)

REFERENCE	QTY.	REMARKS	Project
			Location
			Architect
			Engineer
			Contractor
			Submitted by <span style="float: right;">Date</span>

## DAMPERS

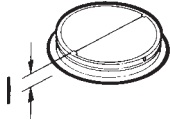

### Model BP87

- 7" round damper
- Extruded steel with electrically-bonded epoxy finish
- .016 Aluminum louvers
- For use with 42000 range hood

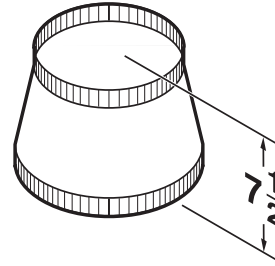

### Model 414

- 10" round to 8" round reducer
- Black, electrically-bonded epoxy finish
- 24 GA galvanized steel

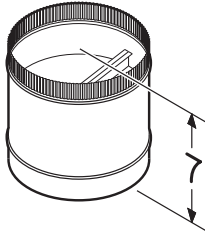

### Model 97

- 7" round damper
- 28 GA galvanized steel
- Aluminum louvers

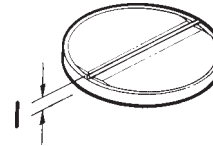

### Model 421

- 10" round damper
- 24 GA galvanized steel with aluminum louvers

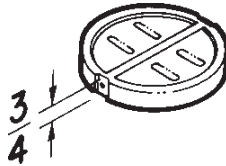

### Model 99

- 9" round damper
- .032 All Aluminum construction
- Spring-loaded aluminum louvers

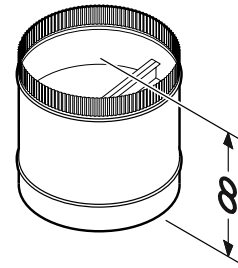

### Model 438

- 8" round damper
- 24 GA galvanized steel with aluminum louvers

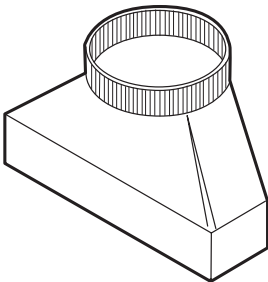

### Model T81212

- 8" x 12" to 12" Round
- 28 ga. galvanized steel

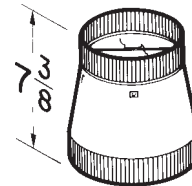

### Model 472

- 10" round to 8" round reducer/damper
- Black, electrically-bonded epoxy finish
- Spring-loaded aluminum louvers
- Rubber stops
- 24 GA galvanized steel



Broan-NuTone LLC, 926 West State Street, Hartford, WI 53027 (1-800-637-1453)  
 NuTone, Inc., 4820 Red Bank Road, Cincinnati, OH 45227 (1-800-543-8687)  
 Broan-NuTone Canada, Inc., 1140 Tristar Drive, Mississauga, Ontario, L5T 1H9 (1-888-882-7626)