

# MODEL 684 CEILING/WALL FAN

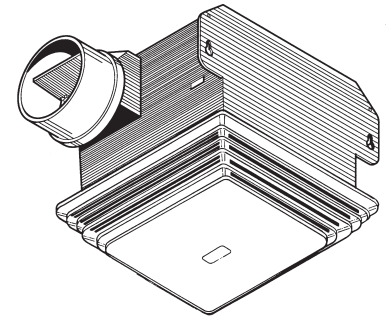

**Dependable, high performance bathroom ventilation.**

### FEATURES

#### GRILLE:

- Attractive grille conceals interior
- Matte white polymeric – blends well with any decor
- Torsion spring grille mounting – no tools required
- White, metal grille kit available (purchase separately)

#### BLOWER:

- Plug-in, permanently lubricated motor
- Centrifugal blower wheel

#### HOUSING:

- Rugged, 26-gage galvanized steel construction
- Sturdy key-holed mounting brackets for quick, accurate installation
- Tapered, polymeric duct fitting with built-in backdraft damper for easy, positive duct connection and no metallic clatter

**Model 2687H:** Rough-in housings for 2684F finish assemblies (packed 4 per carton).

U.L. Listed for use over tubs and showers when connected to a GFCI protected branch circuit

### TYPICAL SPECIFICATION

Ventilator shall be Broan Model 684.

Unit shall have galvanized steel housing with dual integral mounting brackets. It shall be ducted to a roof or wall cap.

Blower assembly shall be removable and have a centrifugal blower wheel and permanently lubricated motor.

Air delivery shall be no less and sound level no greater than values listed in the "Performance Ratings" charts on this sheet. Air and sound ratings shall be certified by HVI and AMCA licensed.

Unit shall be U.L. Listed for use over bathtubs and showers when connected to a GFCI protected branch circuit.



Broan-NuTone LLC certifies that the models shown herein are licensed to bear the AMCA Seal. The ratings shown are based on tests and procedures performed in accordance with AMCA Publication 211 and AMCA Publication 311 and comply with the requirements of the AMCA Certified Ratings Program.



Broan-NuTone LLC Hartford, Wisconsin www.broan.com 800-558-1711

REFERENCE	QTY.	REMARKS	Project
			Location
			Architect
			Engineer
			Contractor
			Submitted by <span style="float: right;">Date</span>

# PERFORMANCE RATINGS - MODEL 684

## AMCA LICENSED PERFORMANCE

Model No.		Static Pressure (in. wg Ps)					Volts	Total Watts	Nominal RPM	Duct Size
		0.0	0.1	.125	.250	.375				
684	CFM	89	89	87	77	59	120	48	1280	4" Round
	Sones	2.7	3.2	3.3	3.6	3.9				

The performance ratings include the effects of inlet grille and backdraft damper in the airstream. Speed (RPM) shown is nominal. Performance is based on actual speed of test. The sound ratings are loudness values in fan sones at 5' (1.5m) in a hemispherical free field calculated per AMCA Std. 301. Values shown are for Installation Type B: Free inlet fan sone levels. Air performance shown is for Installation Type B: Free inlet, Ducted outlet.

## SONES

Model Number	HVI Sones @ 0.1" Ps*	AMCA Sones @ 0.0" Ps*
684	2.5	2.7

\* There is difference between sone values certified by HVI for residential use and by AMCA for commercial/industrial use. Exact comparison of these values is not possible. This difference is mainly due to procedures used to convert measured sound to perceived sound. ANSI S3.4, used by both HVI and AMCA, specifies a procedure for calculating loudness as perceived by a typical listener under specific conditions. HVI establishes values at a distance of 5 feet from the fan in a "spherical free field"; AMCA establishes values at a distance of 5 feet in a "hemispherical free field". HVI and AMCA have different rules for rounding sone values.

## AMPS

MODEL NUMBER	AMPS
684	0.5



Broan-NuTone LLC certifies that the models shown herein are licensed to bear the AMCA Seal. The ratings shown are based on tests and procedures performed in accordance with AMCA Publication 211 and AMCA Publication 311 and comply with the requirements of the AMCA Certified Ratings Program.

## HVI PERFORMANCE

Model	Static Pressure (Ps)	CFM	Sones
684	0.10	80	2.5
	0.25	68	



HVI-2100 CERTIFIED RATINGS comply with new testing technologies and procedures prescribed by the Home Ventilating Institute, for off-the-shelf products, as they are available to consumers. Product performance is rated at 0.1 in. static pressure, based on tests conducted in a state-of-the-art test laboratory. Sones are a measure of humanly-perceived loudness, based on laboratory measurements.

## WEIGHT

MODEL NO.	SHIPPING WT.
684	8.0 lbs.

