

ISOTOPE[®] Owner's Manual

READ AND SAVE THESE INSTRUCTIONS!

Safety and the proper operation of your Casablanca fan both require a thorough knowledge of the product and proper installation. Therefore, before attempting to install and operate your Casablanca fan, read this Owner's Manual completely and carefully. Retain this manual and other included documentation for future reference.

CAUTION: To avoid possible electrical shock, make certain that electricity is turned off at the circuit breaker or fuse box before attempting any installation procedure.

CONTENTS

PARTS GUIDE	3
INTRODUCTION.....	4
Before You Start.....	4
Safe Use	4
MOUNTING RECOMMENDATIONS.....	5
General Guidelines	5
Getting Started.....	5
CEILING MOUNTING PREPARATION AND INSTALLATION.....	6
Ceiling Mounting Plate Installation.....	6
MOTOR HOUSING INSTALLATION.....	7
BLADE PREPARATION AND INSTALLATION	11
LIGHT FIXTURE INSTALLATION.....	12
PRIME•TOUCH2 [®] CONTROL INSTALLATION	13
Control Bracket Installation	13
Remote Operation	14
Changing Transmitter Frequency Setting	14
TROUBLESHOOTING TIPS.....	15
CARE RECOMMENDATIONS	16
PRODUCT SPECIFICATIONS	16



PLEASE INSPECT ALL PACKAGING PRIOR TO DISCARDING!

Your Casablanca fan was crafted with pride and care and inspected thoroughly prior to shipment. Before you begin to assemble and install your Casablanca fan, remove all parts from the carton and check them against the Parts Guide in this manual.

Make sure all parts are included in the box using the Parts Guide on the following pages.

If there are missing or broken parts:

Call 1-888-227-2178 Monday through Friday, 7 a.m. to 4 p.m. PST. Your request will be handled immediately. Replacement parts will be sent to you via Federal Express.

Proper Parts Handling

Do not remove lightbulbs from their packaging until you are ready to install them.

Before discarding packaging materials, be certain that all parts have been removed.

Use a clean, dry paintbrush to remove small Styrofoam pieces that may remain after unpacking.

Do not brush Styrofoam into wiring cavities.

The blades in each pack are matched for equal weight to assure smooth fan operation. If more than one fan is being installed, do not mix blades from different cartons.

When cleaning, painting, or working near your fan, be cautious of the fan and blades.

Always turn power to the ceiling fan OFF before replacing lightbulbs or working on your fan.

Never insert anything into the path of the fan blades while the fan is in operation.

Never install a fan over a pool or spa.

Never operate a fan that has been damaged in any way.

Install the fan according to the instructions in this manual.

If the fan does not work:

Refer to the Troubleshooting Tips in this Owner's Manual.

Call Technical Support at 1-888-227-2178.

Contact your local Authorized Service Center.

Our Web site at www.casablancafanco.com contains additional information on Casablanca products, troubleshooting, and Authorized Dealer or Service Centers. Please do not return this product to the store.

RECORD MODEL AND SERIAL NUMBERS BEFORE INSTALLATION!

Please take a moment to locate the model number and serial number from your fan (see below) and record this information on the Warranty page inside the front cover of your Owner's Manual if it does not appear there already. These numbers are found on the motor identification plate affixed to the fan motor in the location shown below:

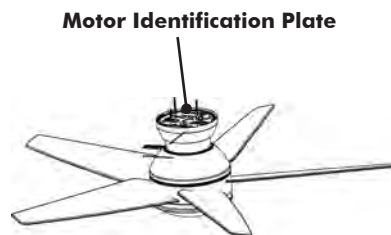



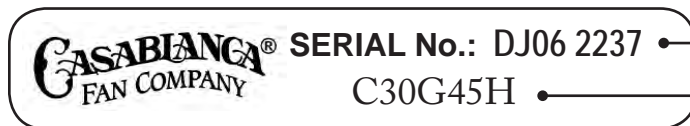
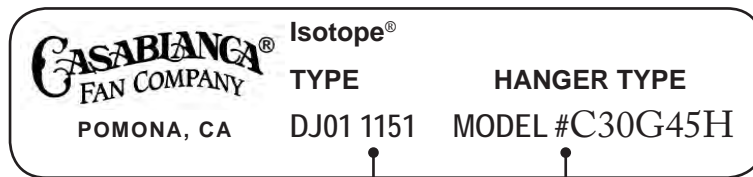









Motor Identification Plate



Serial Number

Model Number

Parts Guide

Item #	Description	Picture (not to scale)	Quantity
1.	Motor Housing		1
2.	Ceiling Mounting Plate		1
3.	Phillips Screwdriver		1
4.	Screw Pack (A): 1 1/2" x 8-32" Roundhead screws and Washers		2 EA
5.	Screw Pack (A): 1 1/2" Wood Screws and Washers		2 EA
6.	Screw Pack (A): 3" Wood Screws and Washers		2 EA
7.	Screw Pack (A): Wire Nuts		3
8.	Screw Pack (B): Fan Mounting Screws		4
9.	Blades		5
10.	Screw Pack (C): Blade Screws and Washers		16 EA
11.	Glass Shade		1
12.	50-watt Halogen Bulbs		2
13.	Prime•Touch W-505 Remote Control and Hardware		1

INTRODUCTION BEFORE YOU START

- **CAUTION: RISK OF ELECTRICAL SHOCK!** Installation is to be in accordance with the National Electrical Code, ANSI/NFPA 70-1999, and local codes. If you are unfamiliar with the wiring codes, you should use a qualified electrician. To avoid overheating and possible damage to other equipment, do not install control to a receptacle, fluorescent light fixture, motor-operated appliance, or transformer-supplied appliance.
- This fan is designed to be installed on an existing electrical outlet box. The outlet box must be UL Listed for ceiling fan installations. If it is not, a new box must be installed.
- This ceiling fan requires a grounded electrical supply of 120 VAC, 60 Hz and a minimum 15 amp circuit. The maximum current requirement for the fan with light fixture is 1.67 amps. The fan uses about .83 amp or 100 watts. Maximum light current is about .83 amps or 100 watts of lighting.
- Where wire nuts are employed, be sure all bare wires are within the connectors. When installing the canopy, make sure all wires are within the canopy and that no wires are being pinched.
- **WARNING:** Do not bend the blade brackets when installing the brackets, balancing the blades, or cleaning the fan. Do not insert foreign objects in between the rotating fan blades.

Unpacking

Before assembling and installing your ceiling fan, remove all parts from the shipping cartons and check them against the parts listed in the Parts Guide. Before discarding packaging materials, be certain that all parts have been removed.

**For best performance and for your warranty to be valid,
use only genuine Casablanca blades, light fixtures, and accessories.**

SAFE USE

- The blades in each pack are matched for equal weight to assure smooth fan operation. If more than one fan is being installed, be careful not to mix blades from different cartons.
- Inspect the contents of your carton for possible shipping or handling damage. If parts are missing or damaged, call 1-888-227-2178.
- It is always a good idea to have an assistant to help with the installation.
- When cleaning, painting, or working near your fan, be very careful of the fan and blades. Always turn the power OFF to the ceiling fan before working on it or replacing lightbulbs.
- Never insert anything into the path of the fan blades while the fan is in operation.
- Never install a fan over a pool or spa.
- Never operate a fan that has been damaged in any way. For assistance in obtaining service, call Casablanca Fan Company at 1-888-227-2178 or contact your local authorized Casablanca dealer.

Fuse Box
(Remove fuse for the circuit you will be working on)

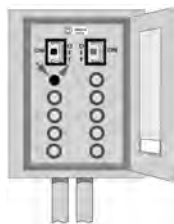

Circuit Breaker
(Trip breaker for the circuit you will be working on)

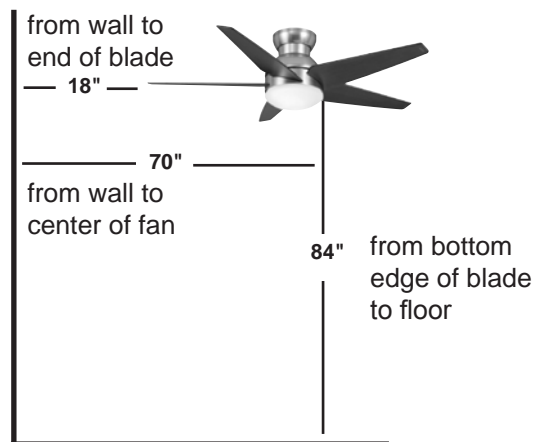
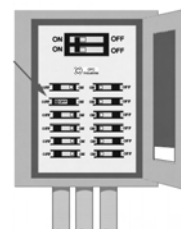

Dimensions indicated are the minimum allowable for proper installation.



MOUNTING RECOMMENDATIONS

GENERAL GUIDELINES

Before mounting your Casablanca fan, read the following helpful recommendations. The location of the fan, air circulation, and fan size are all important factors to consider before installation.

Location

Ceiling fans have practical uses in almost every room in your home. We suggest you follow these mounting recommendations as you decide where to install your Casablanca fan.

- This fan is not suitable for installation on a sloped ceiling.
- For safety reasons, the fan blades must be a minimum of 7' above the floor.
- Do not locate the fan in a doorway or above a swinging door.
- In any installation, the tips of the blades must be at least 18" from the wall in order to provide sufficient clearance for the blades.
- In bedrooms, fans work best when mounted above the foot of the bed.
- Over pool tables, be sure to provide plenty of clearance to avoid damage from pool cues.
- In kitchens be sure to allow for open cupboard doors to clear the fan blades.
- Do not install a fan close to, or over, a pool or spa. High humidity combined with corrosive gases will destroy the finish and warp the blades.

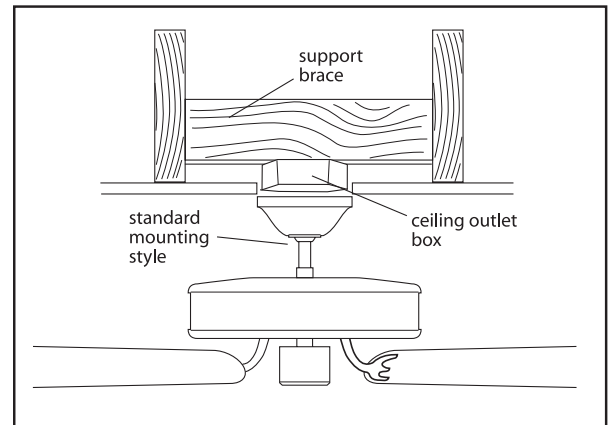
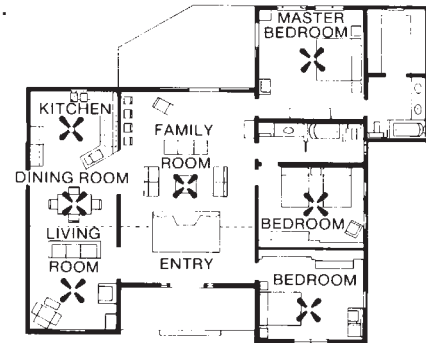

Fan Size

Variable fan speed capability permits the use of a full-size 52" fan even in smaller rooms. For very large rooms, two fans may be needed.

GETTING STARTED

Installing a New Ceiling Fixture Outlet Box

If you do not have an existing fixture located where you wish to place your Casablanca fan, an approved ceiling fixture outlet box must be installed and wired.

WARNING!

To reduce the risk of fire, electrical shock, or personal injury, mount to outlet box marked "Acceptable Fan Support of 22.7 kg (50 lbs.) Or less" using the mounting hardware provided with the outlet box.

Using Existing Ceiling Fixture Outlet Box

After turning the power OFF at its source (either the circuit breaker or fuse box), lower the old fixture and disconnect the wiring. Check the ceiling fixture outlet box to be sure it is marked "Approved for Ceiling Fan Mounting." If it is not, a new box must be installed.

Note: The weight of this fan is 28 pounds.

FAN INSTALLATION

CEILING MOUNTING PLATE INSTALLATION

CEILING HARDWARE (not to scale)



Ceiling Mounting Plate



Screw Pack A:
1/2" Wood Screws (2) and Washers (2)



Screw Pack A:
1 1/2" x 8-32" Roundhead Screws (2)
and Washers (2)



Screw Pack A:
Wire Nuts (3)



Screw Pack A:
3" Wood Screws (2)
Sashers (2)



Phillips
Screwdriver

Note: After removing the old fixture, check the outlet box to ensure that it is supported by a joist or beam across its upper surface. If not, a 2 x 4 stud must be installed.

Step 1a. Carefully feed the ceiling wires through the center hole of the ceiling mounting plate. Attach the plate, as shown with ground wire down, to the ceiling fixture outlet box with the screws provided. Ensure that the outlet box wires are not pinched by the washers or between the mounting plate and the ceiling.

CAUTION:
To reduce the risk of personal injury, use only the mounting hardware provided with the approved outlet box to install the crossbar mounting plate.

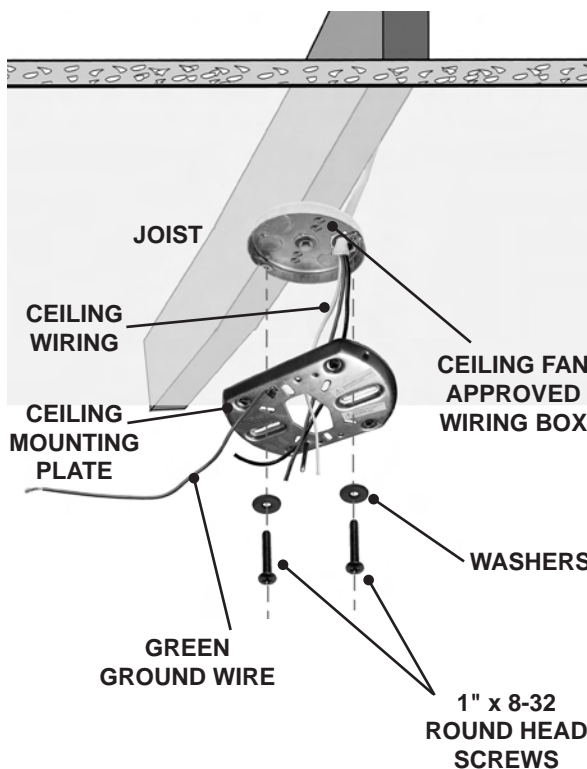



MOTOR HOUSING INSTALLATION

CEILING HARDWARE (not to scale)



Fan Body



Screw Pack B
Fan Mounting Screws (2)



Wire Nuts (3)

Step 2a. Unlock the canopy cover from the canopy ring tabs to loosen and bring down to fan body as shown in Figure #1.

Step 2b. Use the hanging hole on the body of the fan to hang the fan on the hook of the ceiling mounting plate. This will help you in making the electrical connections as shown in Figure #2 and Figure #3.

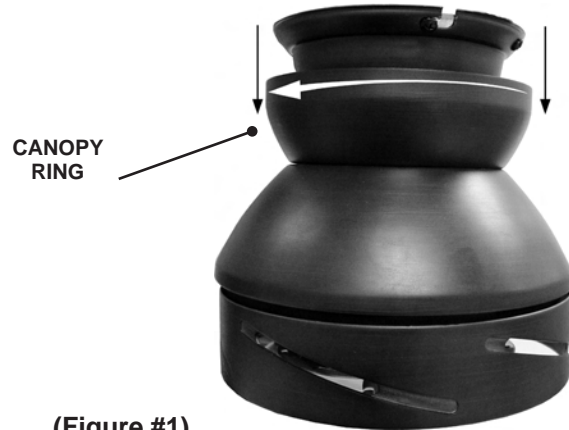

(Figure #1)

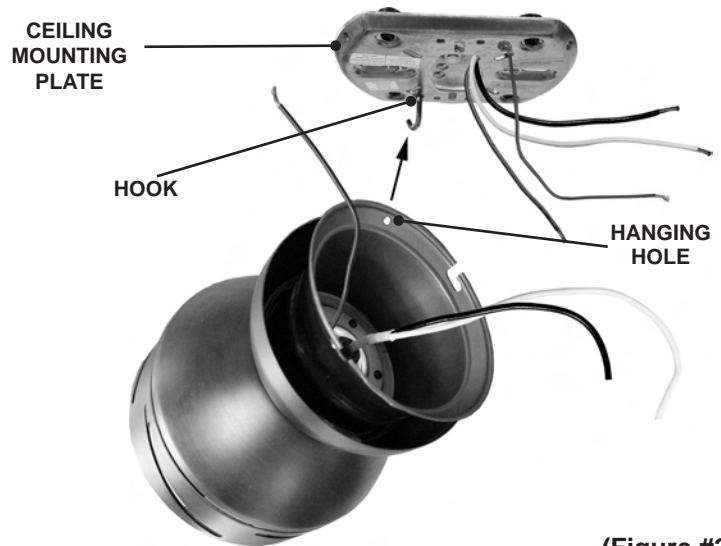

(Figure #2)

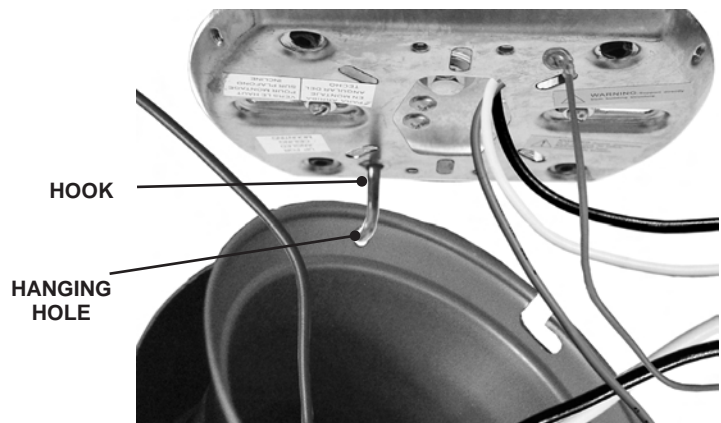

(Figure #3)

Step 2c. Trim excess motor wires to six inches and attach the fan wires to the ceiling bracket wiring by placing the bare end of the wires side by side and then securing with a wire nut. Test that the connection is secure by pulling on the wire nut. Connect in this order:

- GREEN leads from ceiling bracket and motor to GROUND conductor of power source. Secure with wire nut as shown in Figure #4.
- WHITE wire from fan to the WHITE NEUTRAL conductor wire from the power source. Secure with wire nut as shown in Figure #4.
- BLACK wire from fan to the BLACK conductor wire from the power source. Secure with wire nut as shown in Figure #4.

Step 2d. After making the wire connections, the wires should be tucked in to the body of the fan as shown in Figure #5. The wires should be spread apart, with the three grounded conductor wires being placed on one side of the fan body and the power conductor wires being placed onto the other side of the fan body separating the connections.

Step 2e. Locate the two fan mounting screws located on the ceiling mounting plate. Loosen both screws halfway as shown in Figure #6.

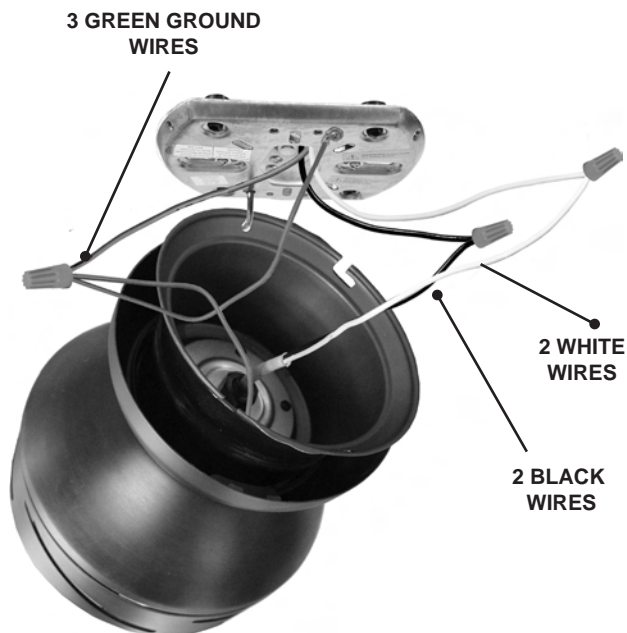

(Figure #4)



(Figure #5)

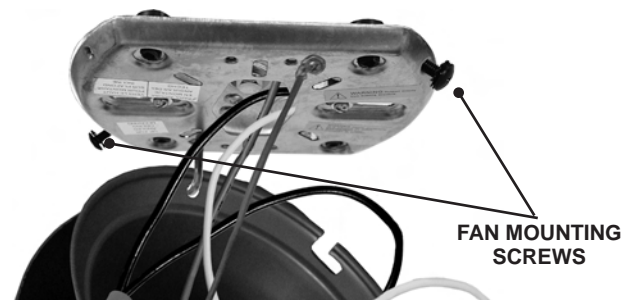

(Figure #6)

Step 2f. Using both hands, lift the fan body from the hook and position the hanging slots on both sides of the fan body, using the two fan mounting screws located on the ceiling mounting plate. Slide the two slots on both sides of the fan body between the head of the screws and rotate the fan body clockwise into the elongated slots as shown in Figure #7.



(Figure #7)

Step 2g. Install the other two fan mounting screws by holding the fan body cover to the ceiling mounting plate as shown in Figure #8. Tighten all four screws until hand tight.

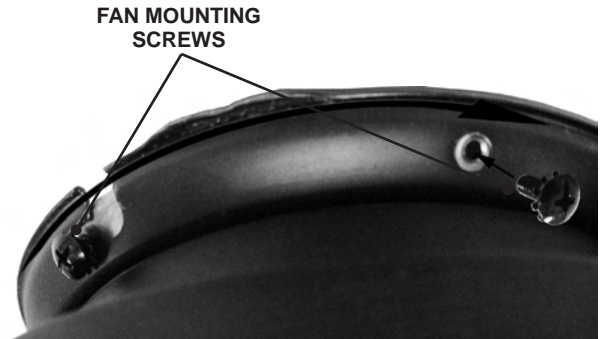

(Figure #8)

Step 2h. Before going to the next step, locate the two sets of canopy ring tabs that are on the top edge of the canopy as shown in Figure #9. Now locate the two sets of canopy tab holders found at the top of the fan body near the ceiling as shown in Figure #10.

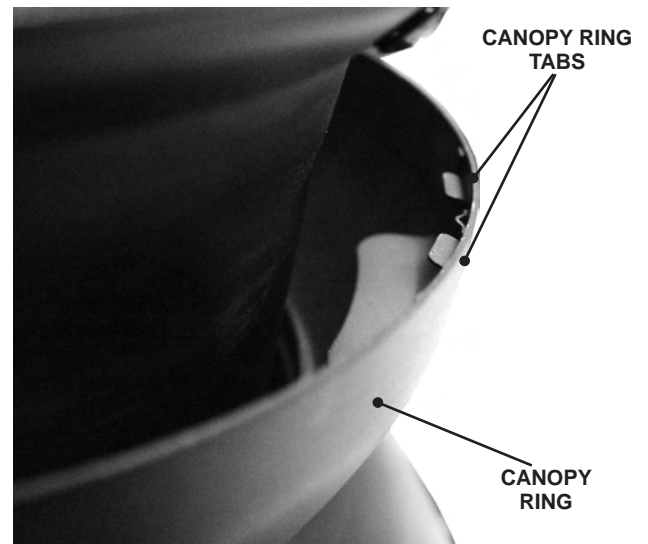

(Figure #9)

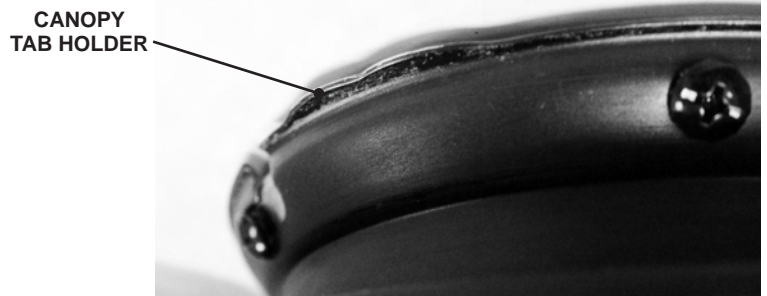

(Figure #10)

Step 2i. To install the canopy ring you will need to lift straight up on the canopy ring. Lock the **CANOPY RING TABS** and the **CANOPY TAB HOLDERS** by rotating the canopy cover clockwise as shown in Figure # 11, locking the canopy ring in to place.

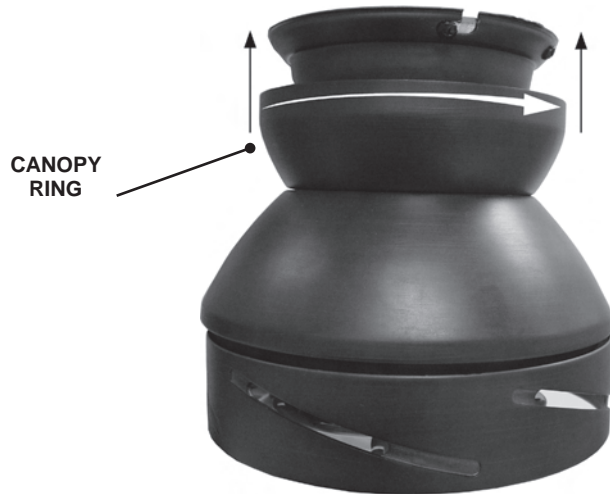

Step 2j. Check your work by making sure the canopy cover has an even gap between the ceiling and canopy ring as shown in Figure #12.

(Figure #11)



(Figure #12)



BLADE INSTALLATION

BLADE HARDWARE (not to scale)



Blades (5)



Blade Screws and Washers (16)



Phillips Screwdriver

Blade Installation

Step 3a. Locate the Casablanca Logo on the end of the blade as shown in Figure #1. Slide the end of the blade into the slot located on the blade ring. (Make sure that the Casablanca Logo is facing downward.) Using three blade screws and washers, attach the blade to the blade ring, as shown in Figure #2. Install three screws and washer one by one using the provided screwdriver. Tighten securely *by hand only*. Repeat until all five blades have been installed on to the fan as shown in Figure #3.

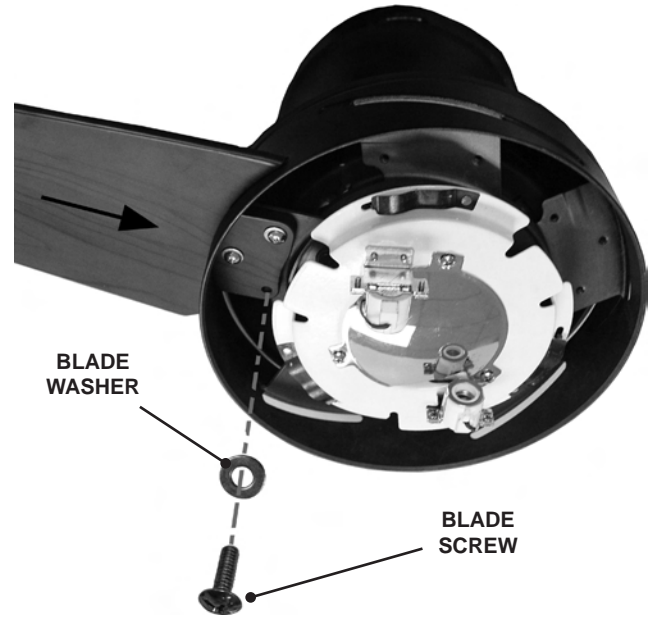

(Figure #2)

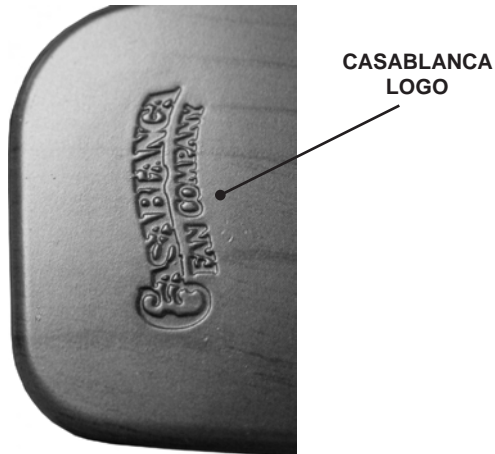

(Figure #1)



(Figure #3)

LIGHT BULB AND GLASS INSTALLATION

HARDWARE (not to scale)



Glass Shade



50 -watt
Halogen Bulbs (2)

Install Halogen Bulbs

Step 4. Screw the two bulbs into the light fixture as shown in Figure #1.

IMPORTANT! When installing a halogen bulb, carefully cut off the end of the plastic sleeve the bulb comes in and hold the bulb by the plastic sleeve to screw it into the socket.

NOTE: When replacing the bulbs, be sure to use only 50-watt maximum.

Glass Installation

Step 5a. Align the glass shade up with the bottom of the fan as shown in Figure #2 and locate the three glass holding slots. Then locate the three glass holding tabs, located on the light fixture plate.

Step 5b. Carefully lift the glass globe up inside the light fixture as far as it will go. Rotate the shade in a counter clockwise direction as shown in Figure #3, until the glass globe is held tightly in place by the three tabs.

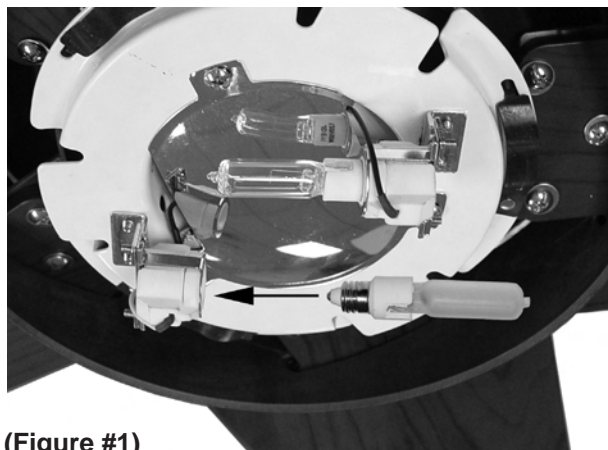

(Figure #1)

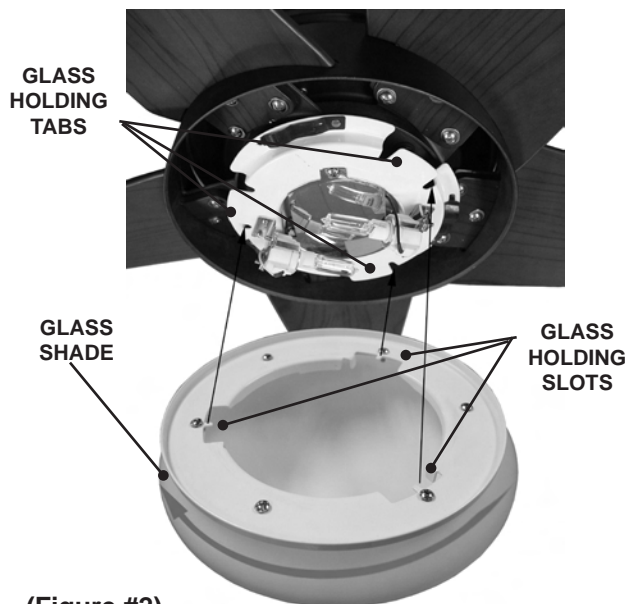

(Figure #2)

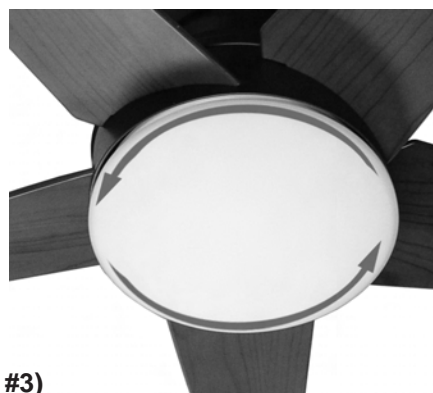

(Figure #3)



PRIME•TOUCH® W-505 CONTROL INSTALLATION

HARDWARE (not to scale)



CONTROL BRACKET INSTALLATION

SAFETY FIRST: To reduce the risk of electrical shock, this fan must be installed with an isolating wall control/switch. CAUTION! Do not use with wall dimmer.

Standard Toggle Light Switch

- Remove the two screws holding the switch cover plate. Do not remove the cover plate.
- Orient the control bracket as shown and line up the two inner mounting holes with those on the switch.
- Insert screws and tighten using the provided screwdriver.

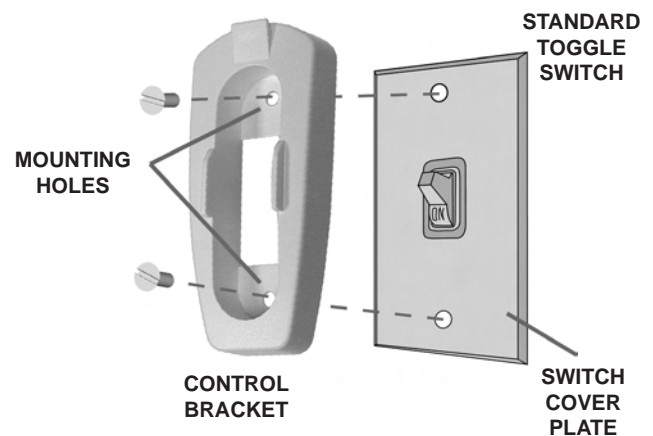

CAUTION! Do not use with wall dimmer or rocker switch.

WARNING! To reduce the risk of fire or electric shock, do not use this fan with any solid state speed control device. Use only the control provided with this fan.

Wall Installation

- Locate a 2 x 4 wall stud in a convenient location.
- Orient the control bracket as shown over the 2x4 stud.
- Use the one-inch wood screws in the inner mounting holes. Insert and tighten the screws using the provided screwdriver.

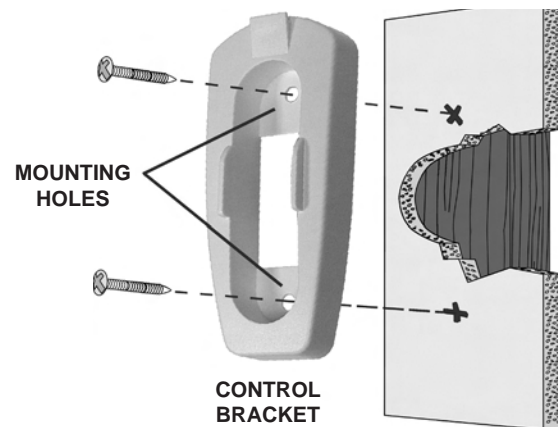

NOTE: The wall anchors and 6-32 x 1" screws may be used in situations where mounting to a stud is not possible. Use the inner mounting holes. After securing the anchor, discard the anchor's pointed screws and use the supplied 6-32 decor ovalhead screws.

NOTICE: Changes or modifications not expressly approved in writing by Casablanca Fan Company may void the user's authority to operate this equipment.

This device complies with RSS-210 of Industry Canada. Operation is subject to the following two conditions: (1) This device may not cause interference, and (2) this device must accept any interference, including interference that may cause undesired operation of the device.



PRIME•TOUCH®

REMOTE OPERATION

Fan Control

To start the fan, press the appropriate speed button to run the fan at the desired speed.

• = LOW speed •• = MED speed ••• = HIGH speed

To turn off the fan, press the FAN OFF button.

Airflow Direction

To reverse the airflow, press the REVERSE button. REVERSE operates at any speed, whether the fan is on or off. The fan returns to its set speed after reversing.

Light Control

Turn the light on or off independently from the fan by pressing the LIGHT button. If you press the button for more than 0.7 seconds, it becomes a dimmer. The light varies from "bright" to "dim" over approximately 8 seconds. If you continue to hold the LIGHT button, this sequence will reverse when the light reaches the brightest or dimmest level. Release the button when the desired level is reached.

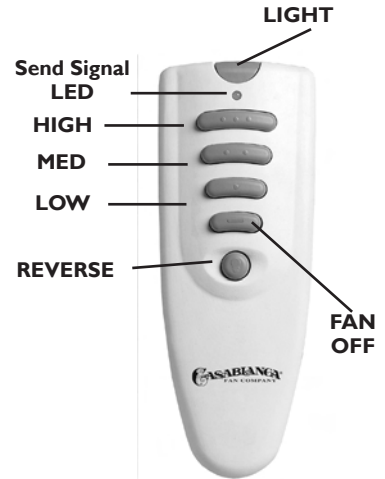

CHANGING TRANSMITTER FREQUENCY SETTING

Note: All fans leave the factory set to "0000."

You will only have to change the dip switch settings in the remote if you are using more than one fan in the same area and want to control them separately.

Step 1. At the circuit breaker or fuse box, turn the power off for the fan you want to change.

Step 2. Open the battery door of the Prime•Touch control and remove the batteries.

Step 3. Change the dip switch settings, assuring that they are different from the previously installed Prime•Touch fan.

Step 4. Replace the batteries and the battery door on the control.

Step 5. At the circuit breaker or fuse box, turn the power back on for the fan whose frequency you are changing.

Step 6. Within 20 seconds of restoring power, push the HIGH, MED, and LOW buttons (in that order).

Note: You may want to label your remote controls to assure you do not mix them up.

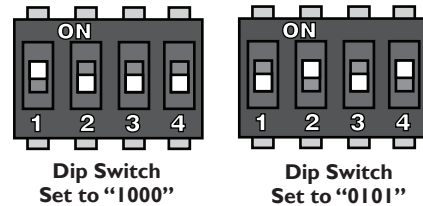

WARNING!

Do not turn the power off at the circuit breaker, then back on, for a previously installed Prime•Touch fan, as you may inadvertently change the frequency settings for it as well.

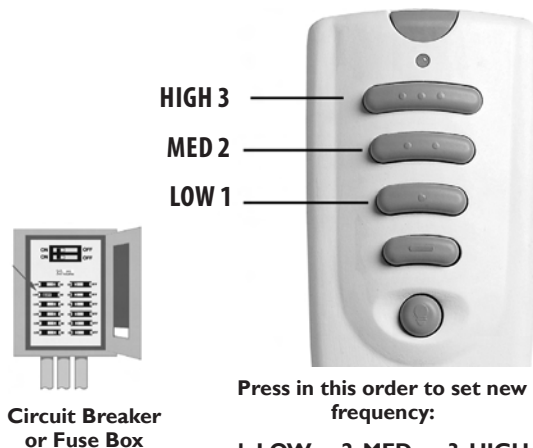



TROUBLESHOOTING TIPS

Please refer to this troubleshooting guide before requesting service or contacting your dealer for assistance.

PROBLEM	POSSIBLE REMEDIES
Fan will not start	<ul style="list-style-type: none"> • Check the main circuit fuses, circuit breakers, and wall switch position. Check all wire connections. Make sure the power is turned off during this inspection. • The battery is weak. Install a fresh battery. • The fan receiver is defective. Replace the fan receiver. • Check the frequency setting: Turn the power off at the circuit breaker for the fan that is not functioning only. Check that the jumper switches match in both the receiver and the transmitter.
Fan wobbles or shakes excessively	<ul style="list-style-type: none"> • Check that the bladeholders have not been bent during installation and that the blades are balanced. • The hanger bracket and/or the ceiling outlet are attached too loosely. Make sure the hanger bracket is attached tightly to the ceiling outlet box and the downrod assembly is secured firmly. • The downrod is attached to the downrod base too loosely. Make sure all the screws are securely tightened.
Fan is noisy during operation	<ul style="list-style-type: none"> • Check and tighten the light fixture retaining screws, glass shade screws, and lightbulbs. • Tighten the canopy screws and mounting plate assembly. Make sure the wire nuts inside the canopy and switch housing are not touching the metal parts and that they have not fallen off the wire splices. Tighten as necessary. • Tighten the blade holders to the flywheel (or Direct Drive motor) and the blades to the bladeholder screws. • Make sure all the screws in the motor housing are snug but not overly tight.
Fan does not run on low speed	<ul style="list-style-type: none"> • If fan is new, it may need to be "broken in." Run at high speed for several days.
Battery life is short	<ul style="list-style-type: none"> • Replace with alkaline batteries.
Light works, but fan does not work	<ul style="list-style-type: none"> • The fan wires are not connected properly.
Fan and light run only on full speed	<ul style="list-style-type: none"> • The fan receiver is defective. Replace the fan receiver.
Fan is missing one speed	<ul style="list-style-type: none"> • The fan receiver is defective. Replace the fan receiver.
Fan does not change speed, but light works	<ul style="list-style-type: none"> • The fan receiver is defective. Replace the fan receiver.
Reverse does not work	<ul style="list-style-type: none"> • The fan receiver is defective. Replace the fan receiver.
Fan starts working by itself	<ul style="list-style-type: none"> • There is frequency interference. Change frequency as described on Page 14.
Fan operates only when transmitter is close	<ul style="list-style-type: none"> • Check that antenna wire is not touching the metal plate.
Fan works, but light does not dim	<ul style="list-style-type: none"> • The fan receiver is defective. Replace the fan receiver.
Fan works, but light does not work	<ul style="list-style-type: none"> • The fan receiver is defective. Replace the fan receiver. • The light socket is broken. Replace the socket. • A lightbulb is defective. Replace the lightbulb.

CARE RECOMMENDATIONS

Fan Finishes

- For cleaning, a soft brush or lint-free cloth should be used to prevent scratching the finish.
- A vacuum cleaner brush nozzle can remove heavier dust.
- Surface smudges or an accumulation of dirt and dust can be removed easily using a mild detergent and slightly dampened soft cloth. An antistatic agent may be used, but *never use abrasive cleaning agents* as these will damage the finish.

Blades

- Wood-finish blades should be cleaned with a furniture polishing cloth. Occasionally, a light coat of furniture polish may be applied for added protection and luster.
- For painted and high-gloss blades, surface smudges or an accumulation of dirt and dust can be removed easily using a mild detergent and slightly dampened soft cloth. An antistatic agent may be used, but *never use abrasive cleaning agents* as these will damage the finish.
- Warning: To reduce the risk of personal injury, do not bend the blade brackets when installing the brackets, balancing the blades, or cleaning the fan. Do not insert foreign objects in between rotating fan blades.

No Need for Lubrication

- *Never lubricate this fan!* The precision motor at the heart of your Casablanca fan features sealed bearings that are lubricated for life.
- Do not attempt to oil the motor.

Changing Lightbulbs

- Be sure to turn the power to OFF at the wall switch or circuit breaker before changing lightbulbs.
- Replace bulbs with the same type as you removed from the light fixture.
- The maximum wattage rating for this fan's light kit is 100 watts for the light.

**For questions or to locate the nearest Casablanca Authorized Service Center,
call toll-free 1-888-227-2178 or visit us on the Web at www.casablancafanco.com**

This device complies with RSS-210 of Industry Canada. Operation is subject to the following two conditions: (1) this device may not cause interference, and (2) this device must accept any interference, including interference that may cause undesired operation of the device.

1. This device complies with part 15 of the FCC Rules. Operation is subject to the following two conditions: (1) this device may not cause harmful interference, and (2) this device must accept any interference received, including interference that may cause undesired operation.

2. This equipment has been tested and found to comply with the limits for a Class B digital device, pursuant to Part 15 of the FCC Rules. These limits are designed to provide reasonable protection against harmful interference in a residential installation. This equipment generates, uses and can radiate radio frequency energy and, if not installed and used in accordance with the instructions, may cause harmful interference to radio communications. However there is no guarantee that interference will not occur in a particular installation. If this equipment does cause harmful interference to radio or television reception, which can be determined by turning the equipment off and on, the user is encouraged to try to correct the interference by one or more of the following measures: Reorient or relocate the receiving antenna, increase the separation between the equipment and receiver, connect the equipment into an outlet on a circuit different from that to which the receiver is connected. Consult the dealer or an experienced radio/TV technician for help. Note: Any changes or modifications to the transmitter or receiver not expressly approved by Casablanca Fan Company may void one's authority to operate this remote control.

PRODUCT SPECIFICATIONS

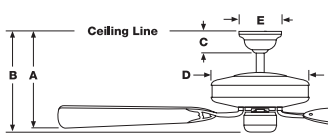
Model Name:	Isotope®	Motor:	188mm x 20mm Direct Drive™
Model Number:	C35GxxH (44") C30GxxH (52")	Blade Span:	44" And 52"
Dimensions:	A = 9.5" B = 12.8" C = N/A" D = 10.2" E = 7.7"	Blade Pitch:	14°
NOTE: Dimension B includes light fixture and glass.		No. of Blades:	5
		Technology:	Prime•Touch® W-505
Weight:	28 lbs.	Lightbulbs:	(2) 50-watt halogen
		Airflow:	3,135 cfm
		Electricity Use*:	71 watts
		Airflow Efficiency*:	43.8 cfm/watt

* Performance data is for fan only. No lighting wattage is included. Measurements taken with 52" model.