

CONTENTS

INTRODUCTION	1
MOUNTING RECOMMENDATIONS	2
FAN INSTALLATION	3
CONTROL FEATURES:	
REMOTE OPERATION	8
TROUBLESHOOTING	10

READ AND SAVE THESE INSTRUCTIONS

SAFETY FIRST

Safety and the proper operation of your Casablanca fan both require a thorough knowledge of the product and proper installation; therefore, before attempting to install and operate your Casablanca fan, read this owner's manual completely and carefully. Retain this manual for future reference.

CAUTION: To avoid possible electrical shock, make certain that electricity is turned off at the circuit breaker or fuse box before attempting any installation procedure.

BEFORE YOU START

- This fan is designed to be installed on an existing electrical outlet box. The outlet box must be UL Listed for ceiling fan installations, if it is not, a new box must be installed. Casablanca extension poles are available for sloped or high ceiling installations.
- This ceiling fan requires a grounded electrical supply of 120 VAC, 60 Hz and a minimum 15 amp circuit. The maximum current requirement for the fan with light fixture is 3.8 amps. The fan uses about 1 amp or 100 watts. Maximum light current is 1 amp or 100 watts of lighting.
- Where wire nuts are employed, be sure all bare wires are within the connectors. When installing the canopy hatch, make sure all wires are within the canopy and that no wires are being pinched.

For best performance and for your warranty to be valid, use only genuine Casablanca blades, light fixtures, and accessories.

SAFE USE

- The blades in each pack are matched for equal weight to assure smooth fan operation. If more than one fan is being installed, be careful not to mix blades from different cartons.
- Inspect the contents of your carton for possible shipping or handling damage and report any such damage directly to your authorized Casablanca dealer.
- It is always a good idea to have an assistant to help with the installation.
- When cleaning, painting, or working near your fan, be very careful of the fan and blades. Always turn the power OFF to the ceiling fan before servicing it, working on it, or replacing light bulbs.
- Never insert anything into the path of the fan blades while the fan is in operation.
- Never install a fan over a pool or spa.
- Never operate a fan that has been damaged in any way. Contact Casablanca Fan Company by calling toll free 1-888-227-2178, or contact your local authorized Casablanca dealer for assistance in obtaining service.

**FUSE BOX
(REMOVE FUSE FOR THE
CIRCUIT YOU WILL BE
WORKING ON)**

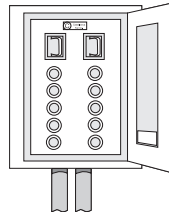

**CIRCUIT BREAKER
(TRIP BREAKER FOR THE
CIRCUIT YOU WILL BE
WORKING ON)**

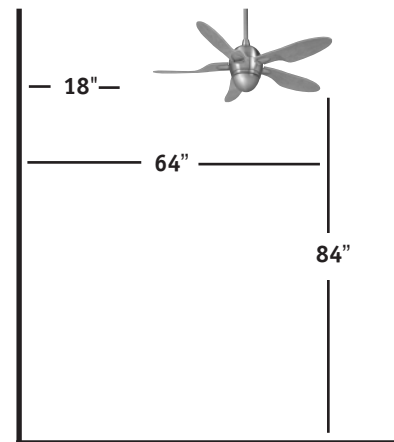
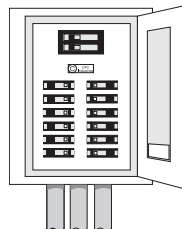

MOUNTING RECOMMENDATIONS

Before mounting your Casablanca fan, read the following helpful recommendations. The location of the fan, air circulation, and fan size are all important factors to consider before installation.

Location

Ceiling fans have practical uses in almost every room in your home. We suggest you follow these mounting recommendations as you decide where to install your Casablanca fan.

- For safety reasons, the fan blades must be a minimum of 7' above the floor.
- Do not locate the fan in a doorway or above a swinging door.
- In any installation, the tips of the blades must be at least 18" from the wall in order to provide sufficient clearance for the blades.
- In bedrooms, fans work best when mounted above the foot of the bed.
- Over pool tables, be sure to provide plenty of clearance to avoid damage from pool cues.
- In kitchens be sure to allow for open cupboard doors to clear the fan blades.
- Do not install a fan close to, or over, a pool or spa. High humidity combined with corrosive gases will destroy the finish and warp the blades.

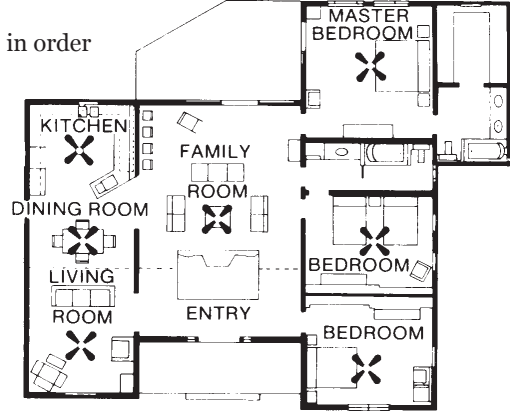

Fan Size

Variable fan speed capability permits the use of a full-size 52" fan even in smaller rooms. For very large rooms, two fans may be needed.

SLOPED CEILING INSTALLATIONS

Suggested Extension Pole Lengths	
Ceiling Height	Pole Length
8"	Standard
8' 6"	Standard
9"	6"
9' 6"	12"
10"	12"
11"	18"
12"	24"
13"	36"
14"	48"

When to Use Extension Poles

For best performance and best appearance, an extension pole should be used with your Casablanca fan when installing on high (cathedral) ceilings or sloped ceilings. Casablanca offers standard poles in increments of 6" up to 5'. Custom poles are available in lengths up to 9'9". See your Authorized Casablanca Dealer for details.

Note: Fan may wobble or vibrate if pole length is not long enough and inside blade is too close to downslope or side wall. Extending pole length will usually solve problem.

Calculation of 32°

Use the tear-off *Ceiling Angle Template* card inserted in the back of this manual, it provides you with a simple 'go' or 'no-go' for installing your fan on a sloped ceiling.

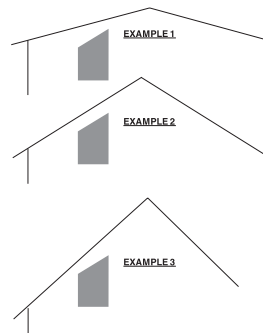
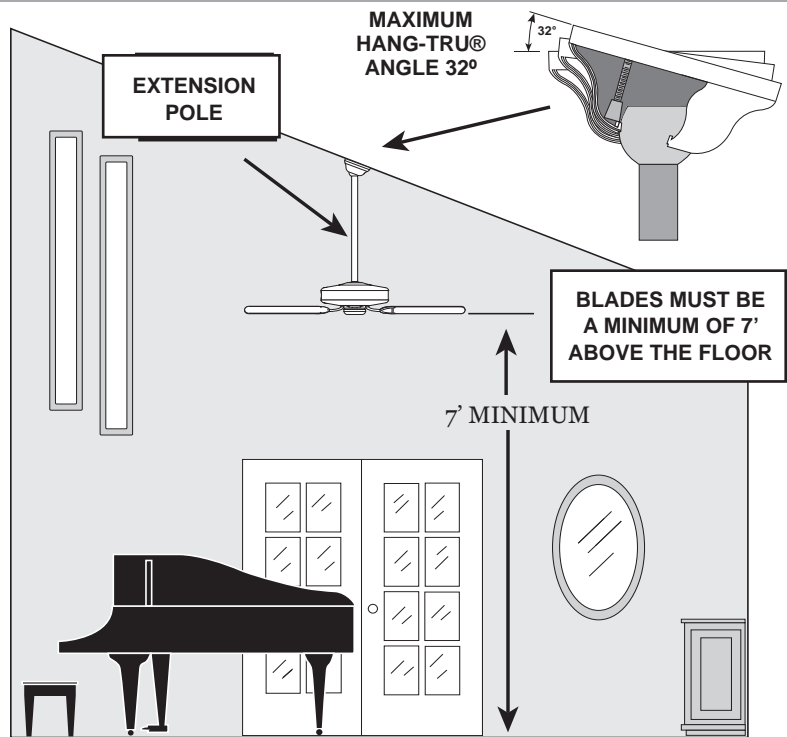

EXAMPLE 1
This slope is less than 32°. It is OK to install your fan.

EXAMPLE 2
This slope is 32°. This is the maximum slope that will allow the fan to hang straight down. It is OK to install your fan.

EXAMPLE 3
This slope is more than 32°. Your fan will not hang straight down, an adaptor is necessary. Contact your local Authorized Casablanca Dealer in regards to purchasing a "Slope Ceiling Adaptor."

INSTALLATION INSTRUCTIONS

IMPORTANT! Leave the fan in the carton until you are ready to hang the fan.

CEILING HARDWARE



CROSSBAR
MOUNTING
BRACKET



WIRE NUT (4)



LAG SCREW AND WASHER
(1)



1" x 8-32 ROUND
HEAD SCREWS (2)



FLAT WASHER (2)

GETTING STARTED

Installing a New Ceiling Fixture Outlet Box

If you do not have an existing fixture located where you wish to place your Casablanca fan, an approved ceiling fixture outlet box must be installed and wired.

After turning the power OFF at its source (either circuit breaker or fuse box), lower the old fixture and disconnect the wiring. Check the ceiling fixture outlet box to be sure that it is marked 'Approved for ceiling fan mounting'. If it is not, a new box must be installed.

Warning: To reduce the risk of fire, electrical shock, or personal injury, mount to outlet box marked acceptable for ceiling fan support using the mounting hardware provided with the outlet box. Using Existing Ceiling Fixture Outlet Box

CROSSBAR MOUNTING BRACKET INSTALLATION

Proceed with installation as follows:

Step 1. To install the crossbar mounting bracket, route the outlet box wires along side of the crossbar mounting bracket. Attach the crossbar mounting bracket to the outlet box with the set of two round-head screws and washers. Use caution when installing the screws and washers. Do not pinch the outlet box wires in the washers. Tighten the screws firmly by hand only, being careful not to bend the bracket by over tightening.

CAUTION: To reduce the risk of personal injury, use only the mounting hardware provided with the approved outlet box to install the crossbar mounting bracket.

Step 2. To install the lag screw, slide the remaining washer onto the lag screw. Pass the lag screw through the center hole in the crossbar mounting bracket. Secure the lag screw into the guide hole, tightening until the ceiling fixture outlet box is firmly mounted to the support beam.

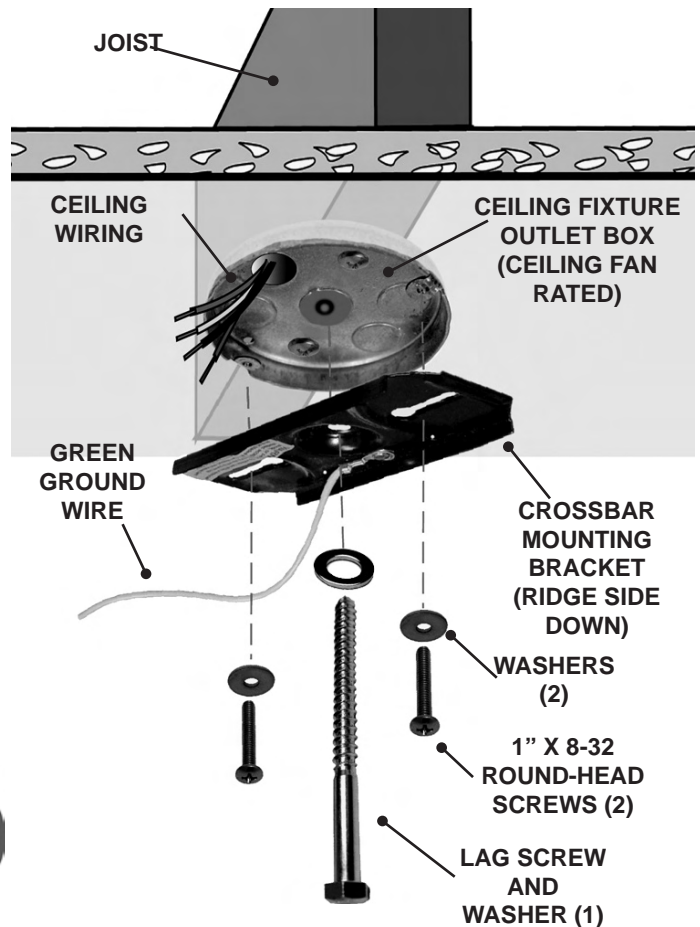

CANOPY HARDWARE

CANOPY HATCH



CANOPY



CANOPY SCREW (4)



CANOPY LOCK WASHER (4)



PHILLIPS SCREWDRIVER

CANOPY INSTALLATION

Step 3. Attach the canopy to the crossbar mounting bracket with three of the 8-32 x 2 1/2" long canopy screws and canopy lock washers. Tighten the screw firmly by hand only.

Note: On sloped ceilings, align the canopy opening towards the top or room peak.

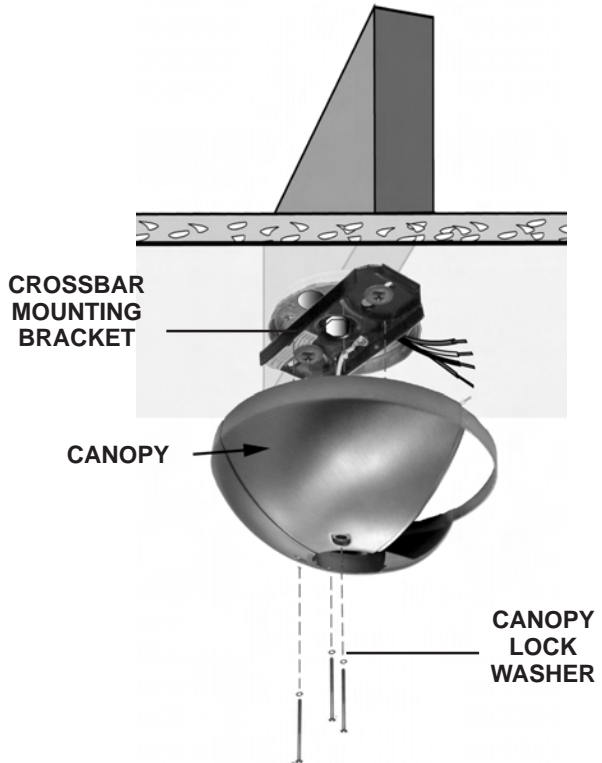

PERMA•LOCK™ HARDWARE



ALLEN SET SCREW
1/4-20
(PRE-INSTALLED)

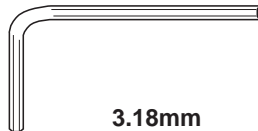

3.18mm
ALLEN WRENCH



DOWNROD & BALL ASSEMBLY

FAN PREPARATION

Prepare for fan installation as follows:

Step 4. Route the wires from the motor through the Perma•Lock™ downrod and ball assembly.

Tip: The downrod has a tapered thread that is designed to lock completely when correctly installed.

Step 5. Using the provided allen wrench, loosen the set screw several turns to allow installation of the downrod. Thread the downrod into the motor coupling until it stops turning, this will take at least four and a half full turns.

Step 6. Securely tighten the set screw with the provided allen wrench to ensure safe operation of your fan.

CAUTION: Failure to fully lock in the downrod before securely tightening the allen set screw may cause the fan to separate from the downrod during normal operation!

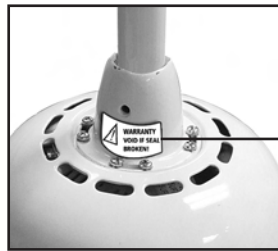
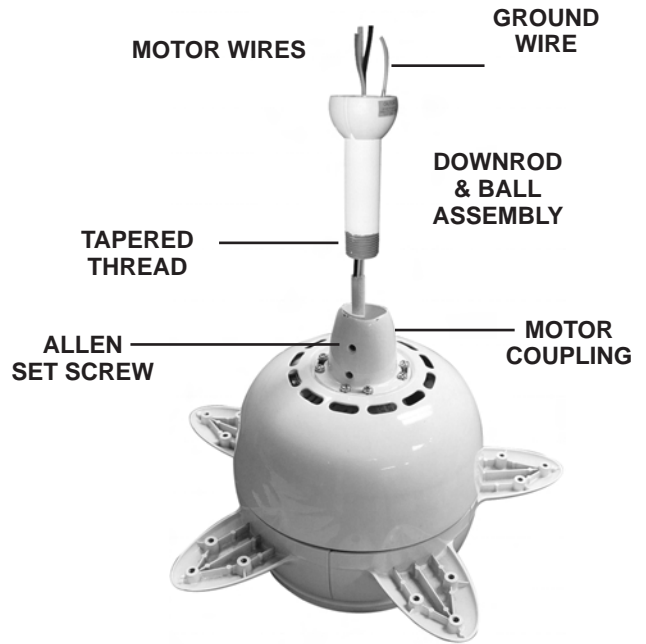

WARNING! DO NOT REMOVE THIS LABEL AND TAMPER WITH ANTI-ROTATION BOTTOM SET SCREW! Unscrewing the bottom set screw may cause fan to separate from the motor shaft during normal fan operation and may cause injuries!

BLADE INSTALLATION



Step 7. Take one blade and align it onto the blade iron of the fan. There is only one way it will fit. Align the blade medallion on to the blade and install the 3 screws per blade. Secure by hand only, do not use a power tool.

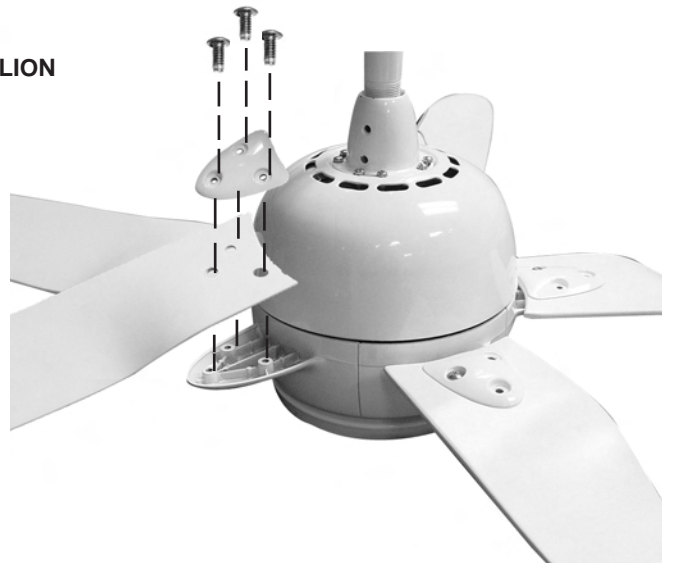

HANGING THE FAN

Step 8. To hang the fan body in the canopy, hold the fan body firmly and insert the ball into the canopy opening. Check that no wires were pinched. Rotate the fan body until the slot in the nylon ball fits into the pin opposite the canopy opening.

NOTE: The fan weight is 28 pounds.

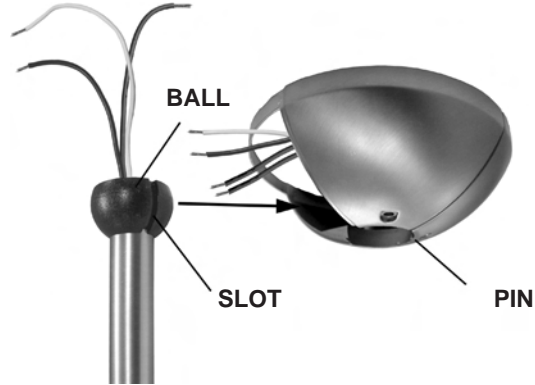

CANOPY ELECTRICAL CONNECTIONS

Step 9a. Attach the fan wires to the ceiling fixture outlet box wiring by twisting the bare ends of the wires together and then securing with a wire nut. Test that the connection is secure by pulling on the wire nut. Connect in this order:

Step 9b. Wiring Connections

- GREEN leads from mounting plate and fan to GROUND conductor of power source. Secure with wire nut.
- WHITE wire from fan to white NEUTRAL wire in ceiling fixture outlet box. Secure with wire nut.
- BLACK power wire from fan to BLACK power wire in ceiling outlet box. Secure with wire nut.

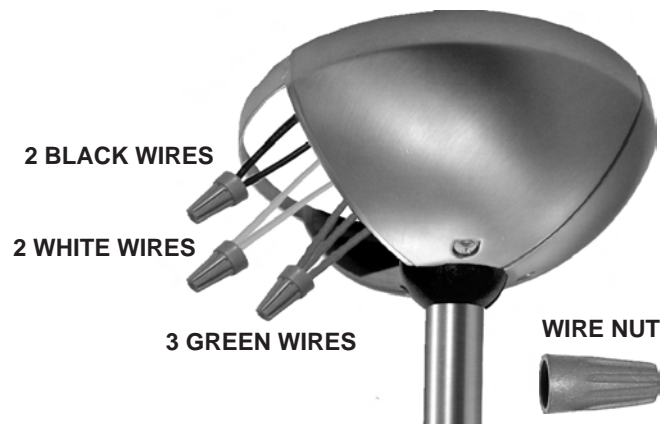

CANOPY HATCH INSTALLATION

Step 10. Tuck the wires into the canopy with the wire nuts pointed upwards, so that the WHITE, GREEN and BLACK wires are on opposite sides of the canopy and all wires are clear of the canopy opening.

Step 11. Install canopy hatch with the last canopy screw and lock washer. To do this, tilt the fan body away from the hatch opening. Tighten the screws firmly by hand only.

Step 12. Straighten the fan, then check to ensure that there is no movement between the canopy and ceiling or Hang-Tru ball and downrod.

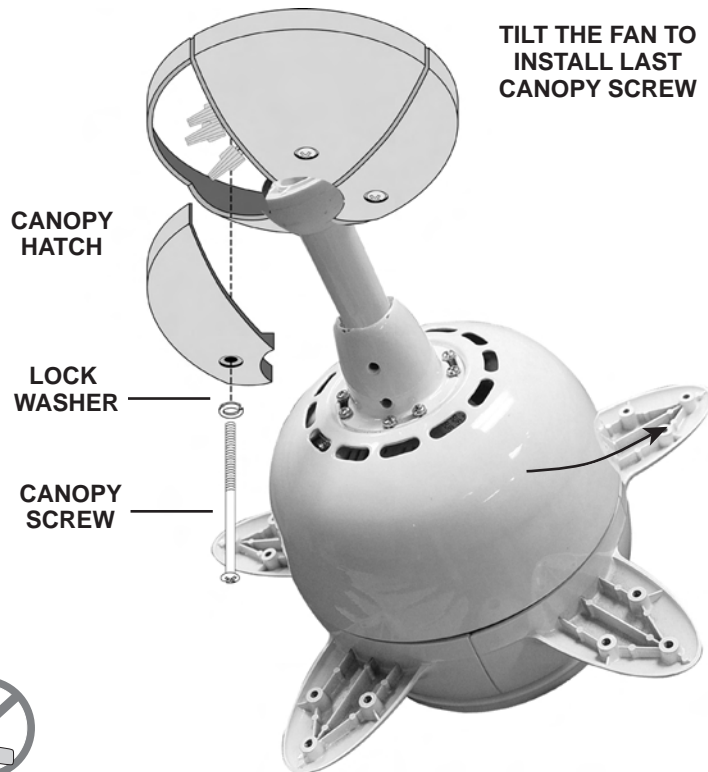

INSTALLATION HALOGEN BULB AND GLASS

Step 13. Screw the 100 Watt Halogen bulb into the socket. If it is touched, or dirty, clean carefully with a tissue. A dirty glass bulb will cause the bulb to fail almost immediately.

CAUTION! Do not touch the bulb with your fingers—it is extremely important that the glass be clean.

Step 14. Position the indentations in the outer rim of the glass shade so that they line up with the tabs on the inside surface of the fan light fixture rim.

Step 15. Carefully lift the glass shade up inside the light fixture as far as it will go.

Step 16. Rotate the shade in a clockwise direction until it is held tightly in place by the three tabs.

CAUTION! Improper installation of glass may cause it to be damaged or it to fall and break.

NOTE: In compliance with US Federal Energy Regulations, this ceiling fan contains a device that restricts the light fixture to a maximum of 190 watts. Exceeding that limit or the marked limit on this product may result in a fire hazard or improper operation.

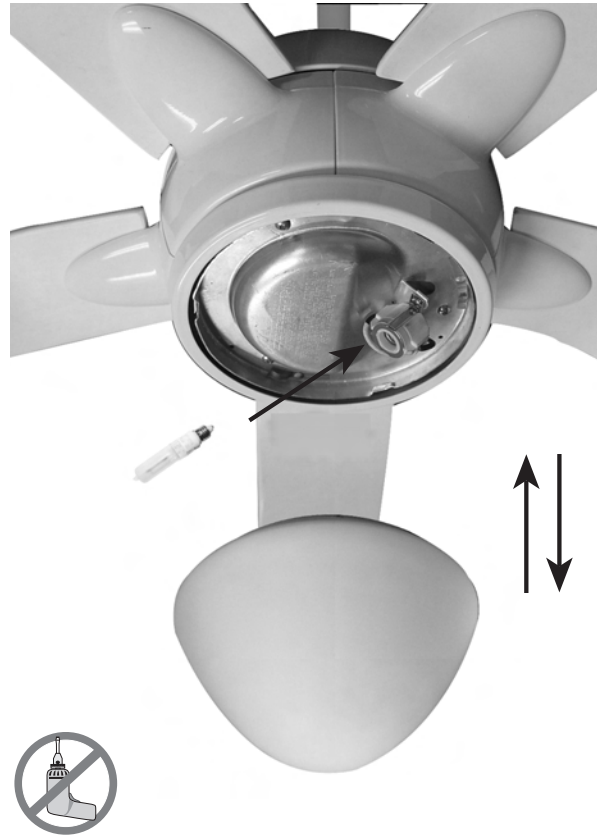

VERSA•TOUCH2® CONTROL INSTALLATION

VERSA•TOUCH2™ HARDWARE (not to scale)



W-72
Control



W-72
Control Holder



12v Battery



Drywall
Anchor
6-32 (2)



Wood
Screw
1" (2)



Screw
6-32 X 3/8"
(2)



Screw
6-32 X 1"
(2)

CONTROL BRACKET INSTALLATION

SAFETY FIRST: To reduce the risk of electrical shock, this fan must be installed with an isolating wall control/switch. **CAUTION!** Do not use with wall dimmer.

WARNING: To reduce the risk of fire or electric shock, do not use this fan with any solid state speed control device. Use only the control provided with this fan.

Step 17. Follow instructions for the type of transmitter control bracket you will be using.

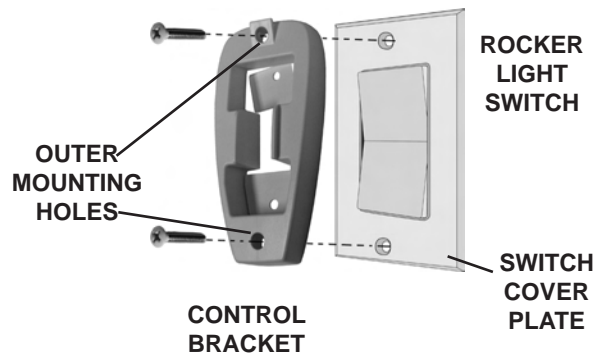
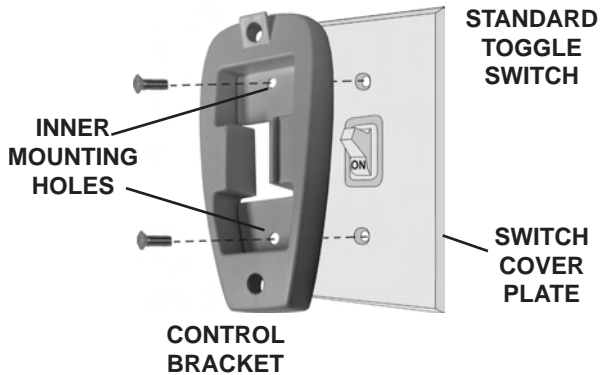

Standard Light Switch

Step A. Remove the two screws holding the switch cover plate. Do not remove the cover plate.

Step B. Orient the control bracket as shown and line up the two inner mounting holes with those on the switch.

Step C. Insert and tighten the screws using the provided screwdriver.

Rocker Light Switch

Step A. Break off the two tabs by pushing outward.

Step B. Remove the two screws holding the switch cover plate. Do not remove the cover plate.

Step C. Orient the control bracket as shown and line up the two inner mounting holes with those on the switch.

Step D. Insert and tighten the screws using the provided screwdriver.

NOTE: The wall anchors and 6-32 x 1" screws may be used in situations where mounting to a stud is not possible. Use the inner mounting holes. After securing the anchor, discard the anchor's pointed screws and use the 6-32 decor ovalhead screws supplied.

Wall Installation

Step A. Locate a 2x4 wall stud in a convenient location.

Step B. Orient the control bracket as shown over the 2x4 stud.

Step C. Insert the 1" wood screws in either the inner or outer mounting holes and tighten using the provided screwdriver.

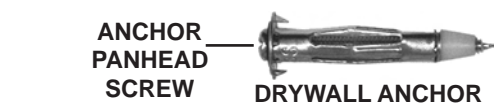
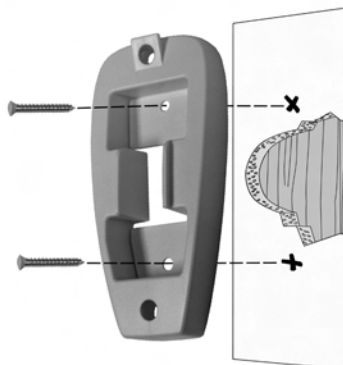

WOOD
SCREW 1"

DECOR OVALHEAD SCREW
6-32 X 1"



REMOTE OPERATION

Fan Control

To start the fan. Press the selected speed button to run the fan at the desired speed.

LOW=Low speed MED=Medium speed HIGH=High speed

To turn off the fan, press the FAN OFF button.

Airflow Direction

To reverse the airflow, press the REVERSE button. REVERSE operates at any speed whether the fan is on or off. The fan returns to its set speed after reversing.

Light Control

Turn the light on or off independently from the fan by pressing the LIGHT button. If you press the button for more than 0.7 seconds, it becomes a dimmer. The light varies from "bright" to "dim" over approximately 8 seconds. If you continue to hold the LIGHT button, this sequence will reverse when the light reaches its brightest or dimmest level. Release the button when the desired level is reached.

Memory Feature

The last light function and fan speed will resume when power is turned back on.

Auto Resume

Quick (pressing less than 0.7 seconds) on/off operation of the LIGHT button maintains the desired brightness level set previously.

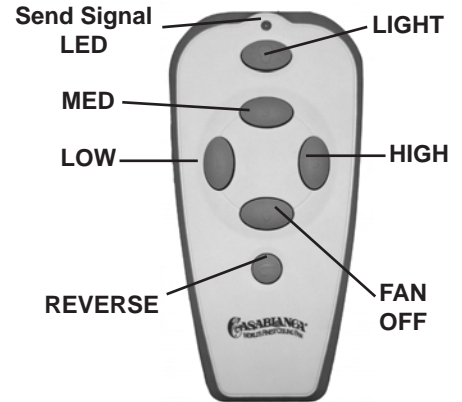

CHANGING TRANSMITTER FREQUENCY SETTING

Note: All fans leave the factory set to "00000."

You will only have to change the dip switch settings in the remote if you are using more than one fan in the same area and want to control them separately.

Step 1. At the circuit breaker or fuse box, turn the power off for the fan you want to change.

Step 2. Open the battery door of the Versa•Touch control and remove the batteries.

Step 3. Change the dip switch settings, assuring that they are different from the previously installed Versa•Touch fan.

Step 4. Re-install the batteries and the battery door on the control.

Step 5. At the circuit breaker or fuse box, turn the power back on for the fan whose frequency you are changing.

Step 6. Within 20 seconds of restoring power, push the HIGH, MED, and LOW buttons (in that order).

Note: You may want to label your controls to assure you do not mix them up.

If the fan is not functioning after installation:

Step 1. Check to make sure that batteries are installed correctly in the control.

Step 2. Turn the power off to the fan (from the circuit breaker) for at least 5 seconds.

Step 3. Turn the power back on (at the circuit breaker) and push the HIGH, MED, and LOW buttons—in that order—within 20 seconds.

Step 4. The fan should now function properly.

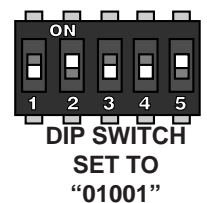
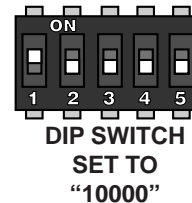
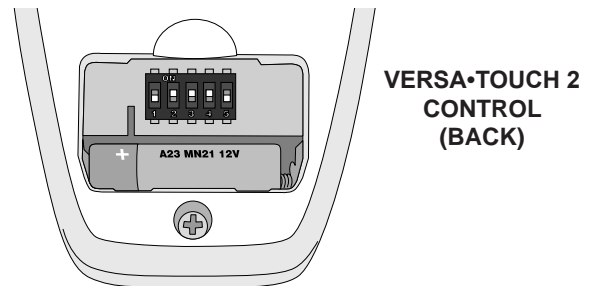

WARNING!
Do not turn the power off at the circuit breaker, then back on, for the previously installed Versa•Touch2 fan(s), as you may inadvertently change the frequency settings for it as well.

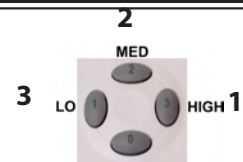
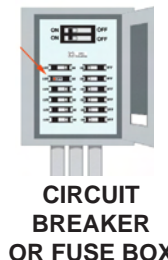

PRESS IN THIS ORDER TO SET NEW FREQUENCY:
1. HIGH 2. MED 3. LOW

TROUBLESHOOTING TIPS

Please refer to this troubleshooting guide before requesting service or contacting your dealer for assistance.

PROBLEM	POSSIBLE REMEDIES
Fan will not start	<ul style="list-style-type: none"> • Check the main circuit fuses, circuit breakers, and wall switch position. Check all wire connections. Make sure the power is turned off during this inspection. • The 9-pin connector is not making good contact. Check the 9-pin connector in the receiver mounted in the switch housing • The battery is weak. Install a fresh battery. • The fan receiver is defective. Replace fan receiver. • Check the frequency setting: Turn the power off at the circuit breaker, only for the fan that is not functioning. Check that the jumper switches match in both the receiver and the transmitter.
Fan wobbles or shakes excessively	<ul style="list-style-type: none"> • Be sure the canopy pin is set properly into the slot on the ball. • Check that the bladeholders have not been bent during installation and the blades are balanced. • The hanger bracket and/or ceiling outlet are attached too loosely. Make sure the hanger bracket is attached tightly to the ceiling outlet box and the downrod assembly is secured firmly. • The downrod is attached to downrod base too loosely. Make sure all the screws are securely tightened.
Fan is noisy during operation	<ul style="list-style-type: none"> • Check and tighten the light fixture retaining screws, glass shade screws, and/or lightbulb(s). • Tighten the canopy screws and mounting plate assembly. Make sure the wire nuts inside the canopy and switch housing are not touching the metal parts and that they have not fallen off the wire splices. Tighten as necessary. • Tighten the blade holders to the flywheel (or direct drive motor) and the blades to the bladeholder screws. • Make sure all screws in the motor housing are snug but not overly tight.
Fan does not run on low speed	<ul style="list-style-type: none"> • If fan is new, it may need to be “broken in.” Run at high speed for several days.
Battery life is short	<ul style="list-style-type: none"> • Replace with alkaline batteries.
Light works, but fan does not work	<ul style="list-style-type: none"> • The fan wires are not connected properly.
Fan and light run only on full speed	<ul style="list-style-type: none"> • The fan receiver is defective. Replace fan receiver.
Fan is missing one speed	<ul style="list-style-type: none"> • The fan receiver is defective. Replace fan receiver.
Fan does not change speed, but light works	<ul style="list-style-type: none"> • The fan receiver is defective. Replace fan receiver.
Reverse does not work	<ul style="list-style-type: none"> • The fan receiver is defective. Replace fan receiver.
Fan starts working by itself	<ul style="list-style-type: none"> • There is frequency interference. Change frequency.
Fan operates only when transmitter is close	<ul style="list-style-type: none"> • Check that antenna wire is not touching metal plate.
Fan works, but light does not dim	<ul style="list-style-type: none"> • The fan receiver is defective. Replace fan receiver.
Fan works, but light does not work	<ul style="list-style-type: none"> • The fan receiver is defective. Replace fan receiver. • The light socket is broken. Replace socket. • A lightbulb is defective. Replace lightbulb.

NOTE: In compliance with US Federal Energy Regulations, this ceiling fan contains a device that restricts the light fixture to a maximum of 190 watts. Exceeding that limit or the marked limit on this product may result in a fire hazard or improper operation.

PRODUCT SPECIFICATIONS

Model Name: Modena® II
 Model Number: C10GXXM

Motor: 188mm x 20mm Direct Drive™
 Blade Span: 47"
 Blade Iron Pitch: Dynamic
 No. of Blades: 5
 Technology: Versa•Touch2® W-72
 Lightbulb: (1) 100-watt halogen

Dimensions: A = 11.8"
 B = 16.75"
 C = 2.8"
 D = 8.17"
 E = 7.0"

NOTE: Dimension B includes light fixture and glass.

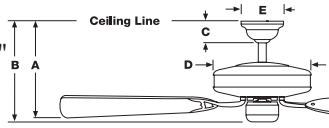

Weight: 28 lbs.

Airflow: 5,832 cfm
 Electricity Use*: 72 watts
 Airflow Efficiency*: 81 cfm/watt

* Performance data is for fan only. No lighting wattage is included.

For questions or to locate the nearest Casablanca Authorized Service Center call toll free: 1-888-227-2178 or visit us on the web at: www.casablancafanco.com

1. This device complies with Part 15 of the FCC Rules. Operation is subject to the following two conditions: (1) this device may not cause harmful interference, and (2) this device must accept any interference received, including interference that may cause undesired operation.
 2. This equipment has been tested and found to comply with the limits for a Class B digital device, pursuant to Part 15 of the FCC Rules. These limits are designed to provide reasonable protection against harmful interference in a residential installation. This equipment generates, uses and can radiate radio frequency energy and, if not installed and used in accordance with the instructions, may cause harmful interference to radio communications. However, there is no guarantee that interference will not occur in a particular installation. If this equipment does cause harmful interference to radio or television reception, which can be determined by turning the equipment off and on, the user is encouraged to try to correct the interference by one or more of the following measures: Reorient or relocate the receiving antenna, Increase the separation between the equipment and receiver, Connect the equipment into an outlet on a circuit different from that to which the receiver is connected, Consult the dealer or an experienced radio/TV technician for help. Note: Any changes or modifications to the transmitter or receiver not expressly approved by Casablanca Fan Company may void one's authority to operate this remote control.