

TECHNICAL SPECIFICATIONS

Brookhaven

Pressure balance mixing valve

code | 245 606 xxx
246 606 xxx

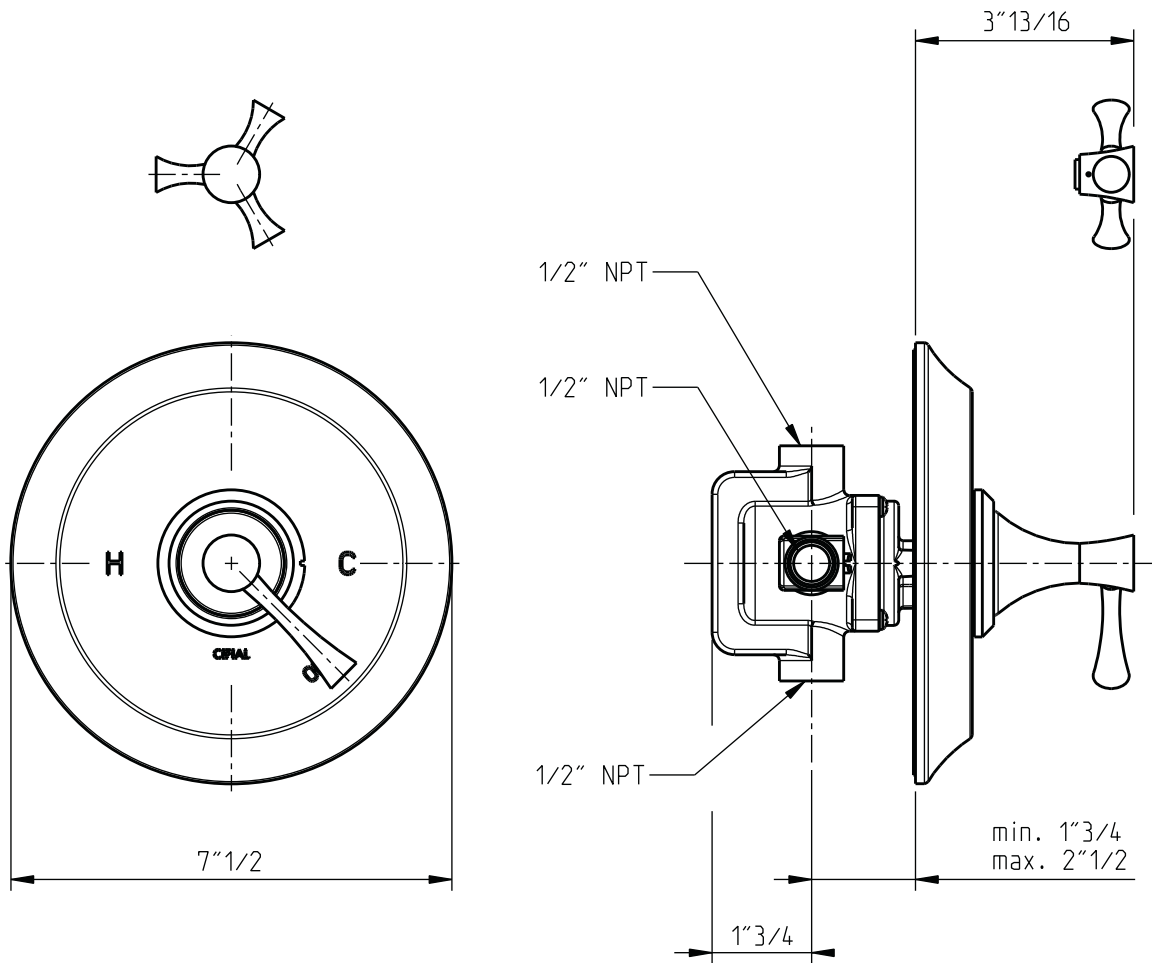

Rough: 289 705 999 or 289 708 999 (sold separately)

5663517
983MW014W04

dimensions inches

PLUMBING

CIFIAL USA
USA P +1800 5284904 F +1800 5281969 info@cifialusa.com www.cifialusa.com
CIFIAL Torneiras, S.A.
Portugal T +351 256 780 700 F +351 256 780 710 cifial@cifial.pt www.cifial.pt
CIFIALDECOR, S.A.
Espanha T +34 916 110 261 F +34 916 103 694 cifialdecor@infonegocio.com
CIFIAL UK, Ltd.
UK P +44 1933 402 008 F +44 1933 402 063 sales@cifial.co.uk www.cifial.co.uk



Assembly instructions

- 1 | Place **stem extension** onto valve stem using **screw**.
- 2 | Slide **face plate** into place and engage **stem extension** using **face plate screws**.
- 3 | Set high temperature limit stop by turning handle drive shaft counter clockwise until desired maximum temperature is reached. Place **temperature limit ring** onto handle drive shaft with arm set next to limit stop pin. Turn handle drive shaft clockwise to shut off valve.
- 4 | Place **rosette** onto handle drive shaft and align mark with off position. Thread **bonnet** into drive shaft. Tight **cross handle** with **screw** and place **handle top**.
- 5 | Tight **handle set screw** into **handle body** and thread **lever extension**.

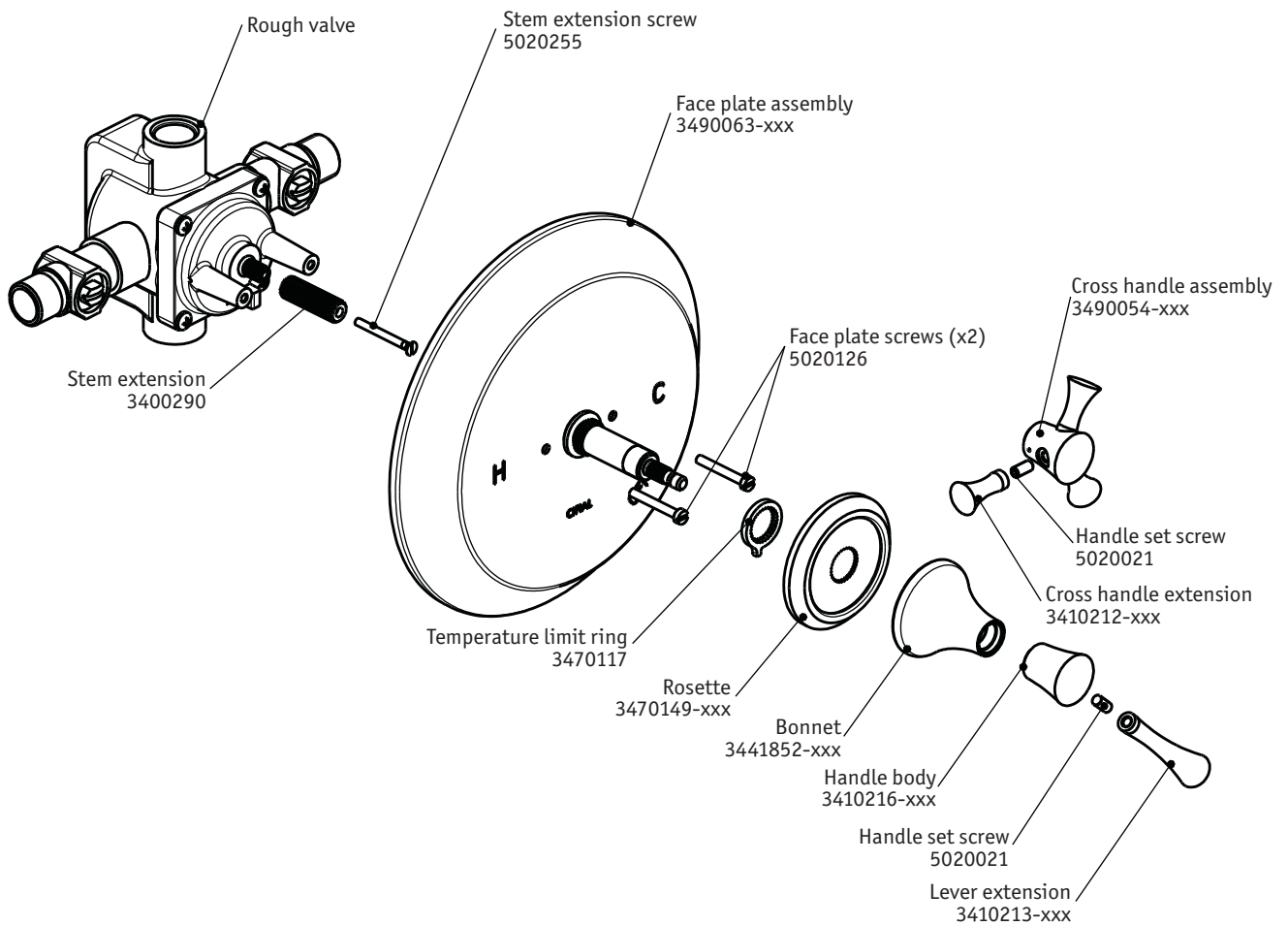

5663517
983MW014W04

Note: xxx represent different finishes.