

531319

# ASSEMBLY INSTRUCTIONS

# PARTS LIST:

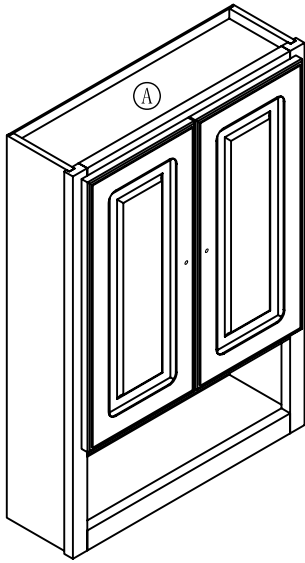

ASSEMBLY 1PC

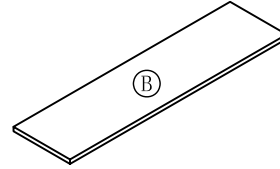

ADJUSTABLE SHELF 2PCS

# HARDWARE LIST:

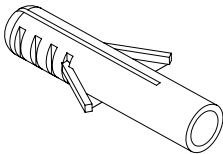

a. WALL ANCHOR 4PCS

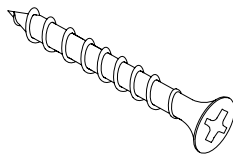

b. FLAT HEAD SCREW 4PCS

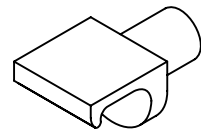

d. PIN 8PCS

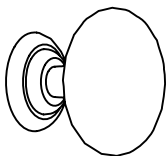

l. KNOB 2PCS

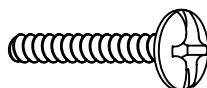

n. KNOB BOLT 2PCS

# STEP 1

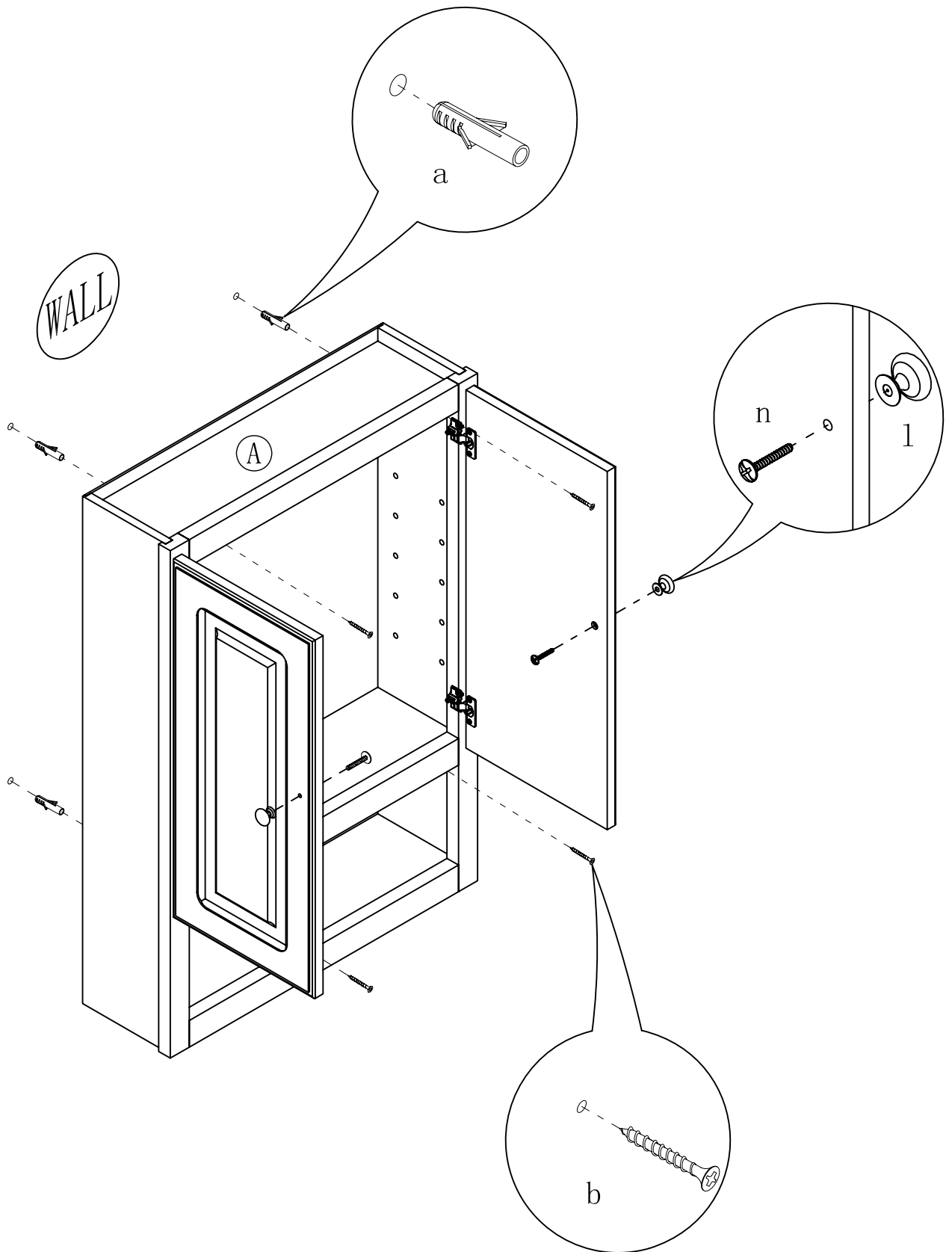

# STEP 2

