

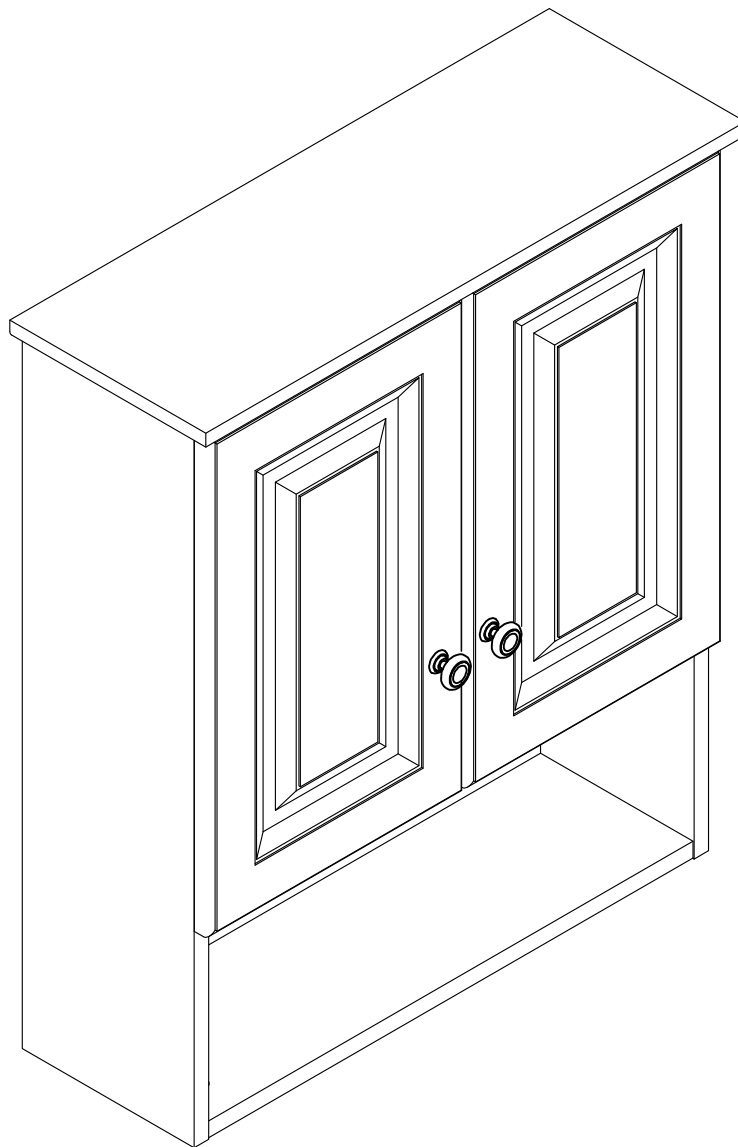

www.todaysdesignhouse.com



531962

ASSEMBLY INSTRUCTIONS

DHI Corp. • 5205 W. Donges Bay Rd. • Mequon, WI 53092 • 800.558.8700

PARTS LIST:

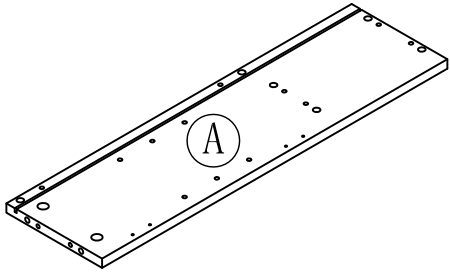

LEFT SIDE PANEL 1PC

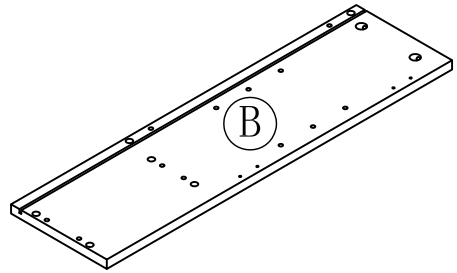

RIGHT SIDE PANEL 1PC

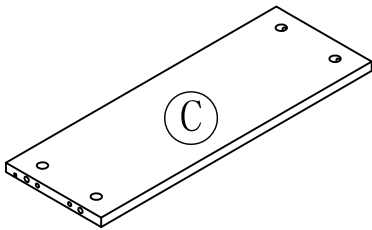

BOTTOM PANEL 1PC

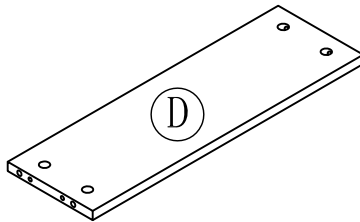

FIXED PANEL 1PC

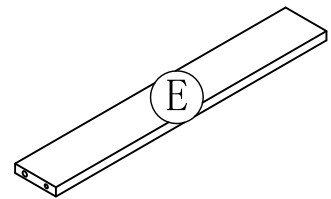

BACK CROSS BRACE 2PCS

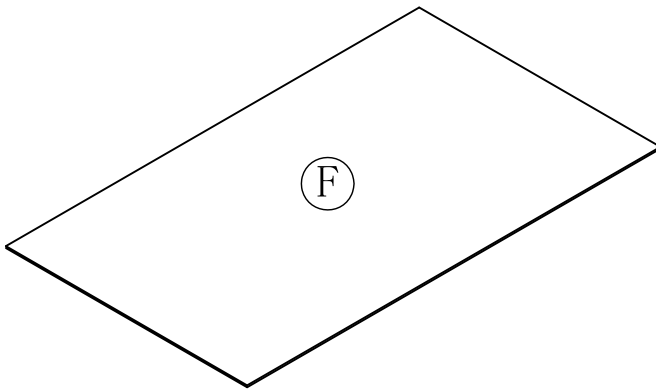

BACK PANEL 1PC

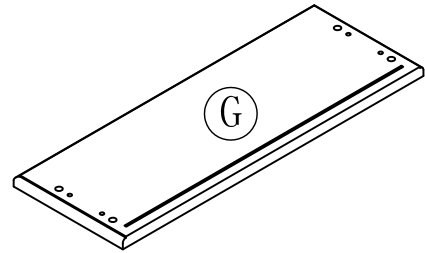

TOP PANEL 1PC

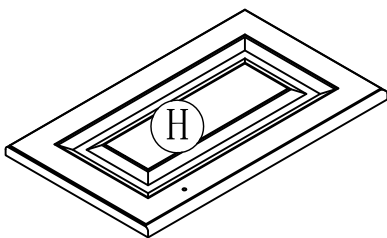

LEFT DOOR 1PC

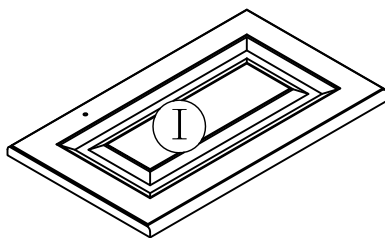

RIGHT DOOR 1PC

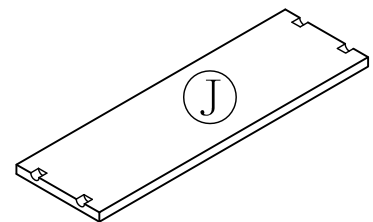

ADJUSTABLE PANEL 1PC

HARDWARE LIST:



a. WOOD DOWEL 16PCS

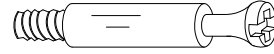

b. CAM LOCK SCREW 16PCS



c. CAM LOCK 16PCS



d. KNOB BOLT 2PCS

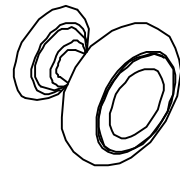

e. KNOB 2PCS

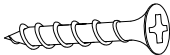

f. 5/8" FLAT HEAD
SCREW 24PCS

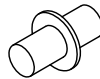

h. PIN 4PCS

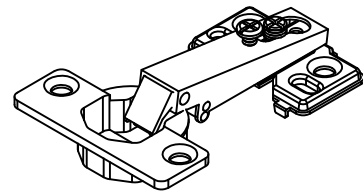

g. HINGE 4PCS



i. "L" WRENCH 1PC

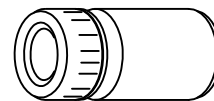

j. GLUE 1PC

STEP 1

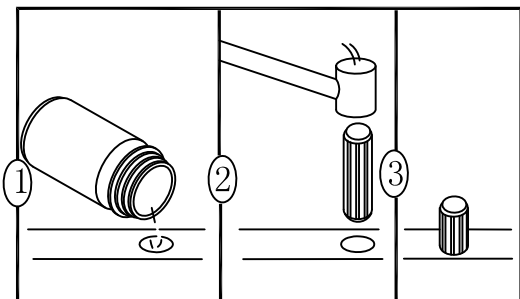
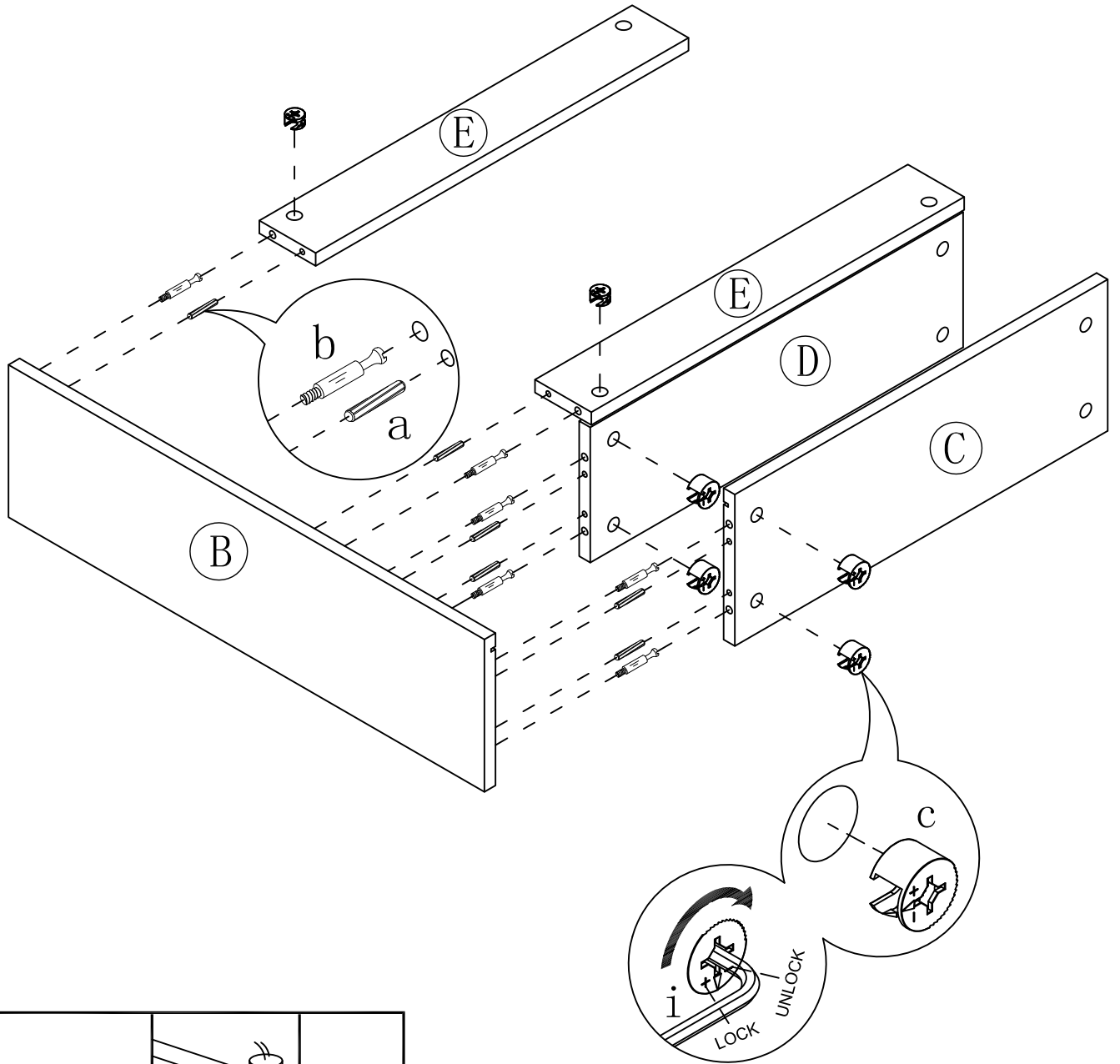

STEP 2

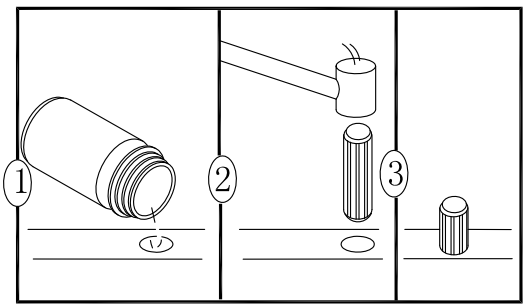
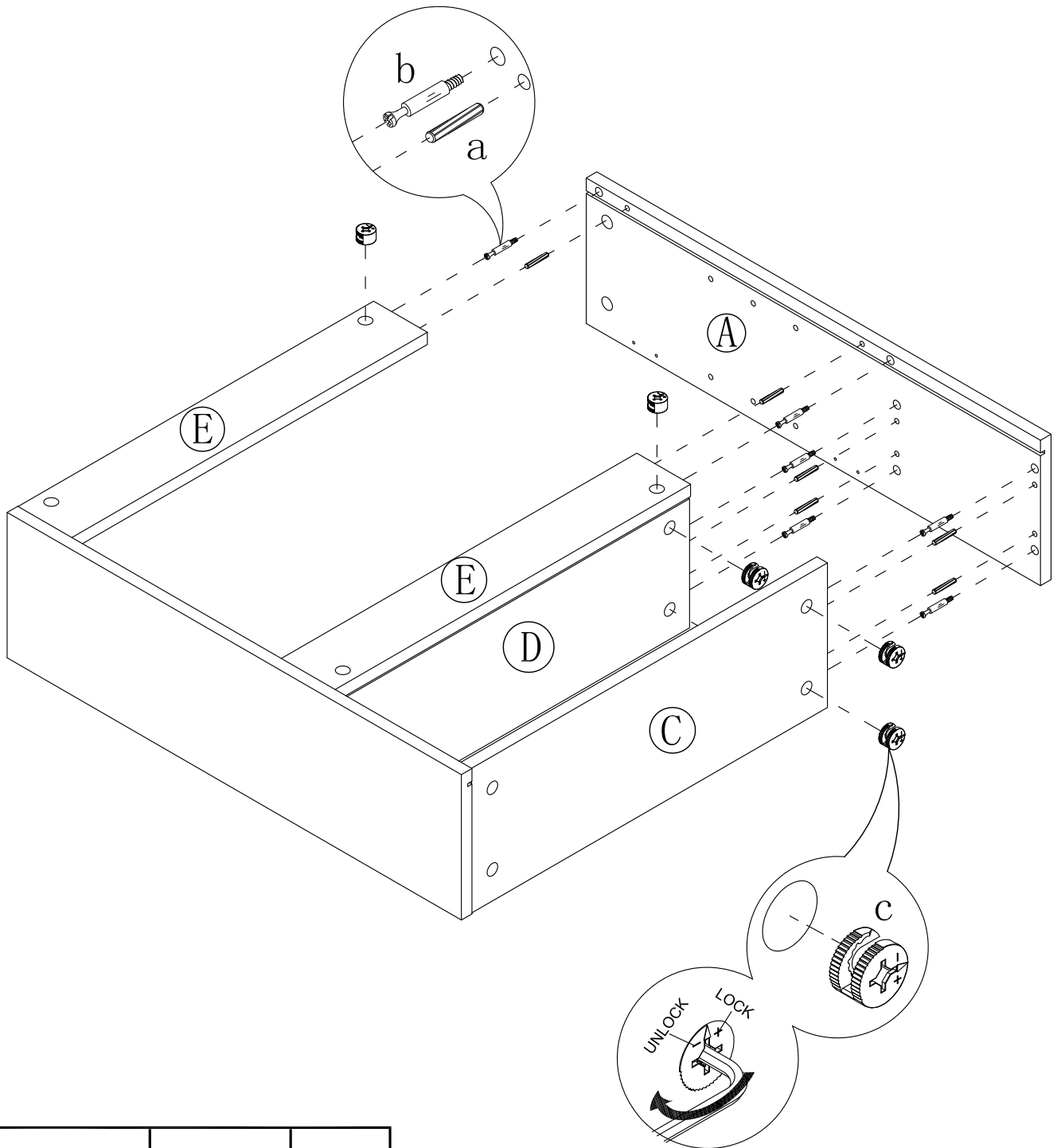

STEP 3

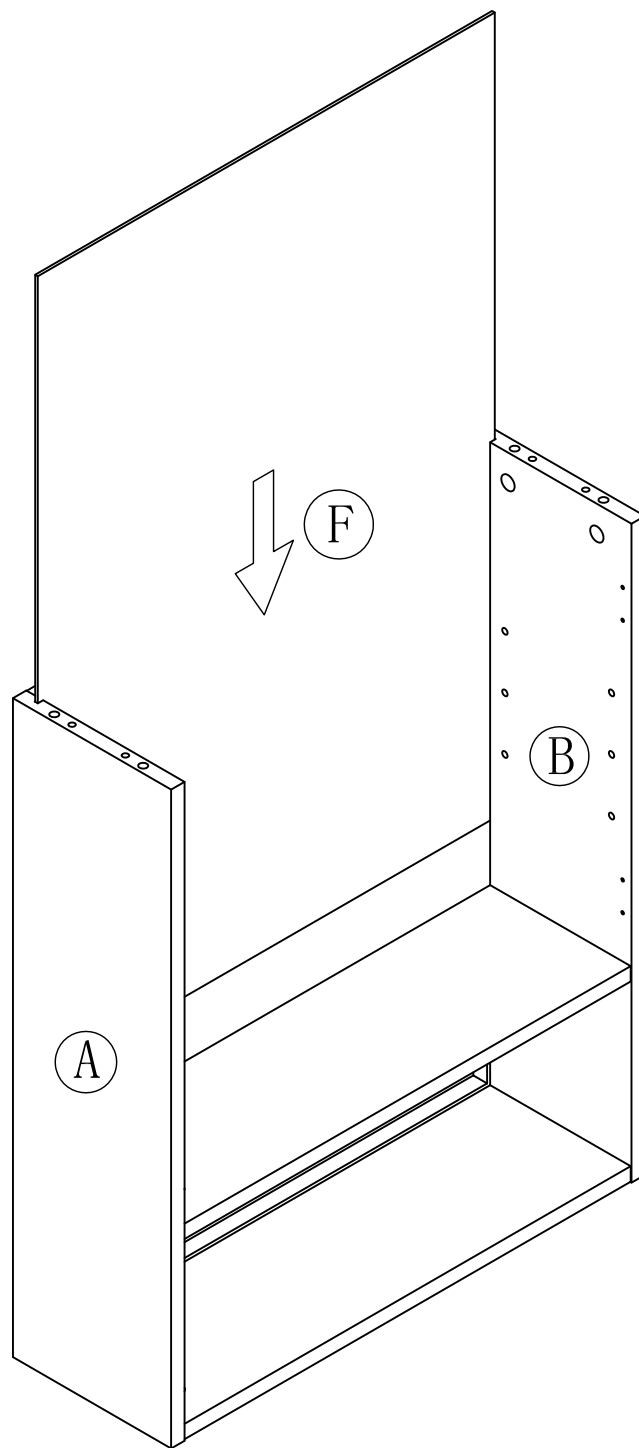

STEP 4

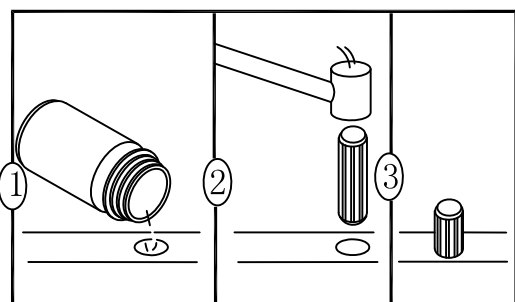
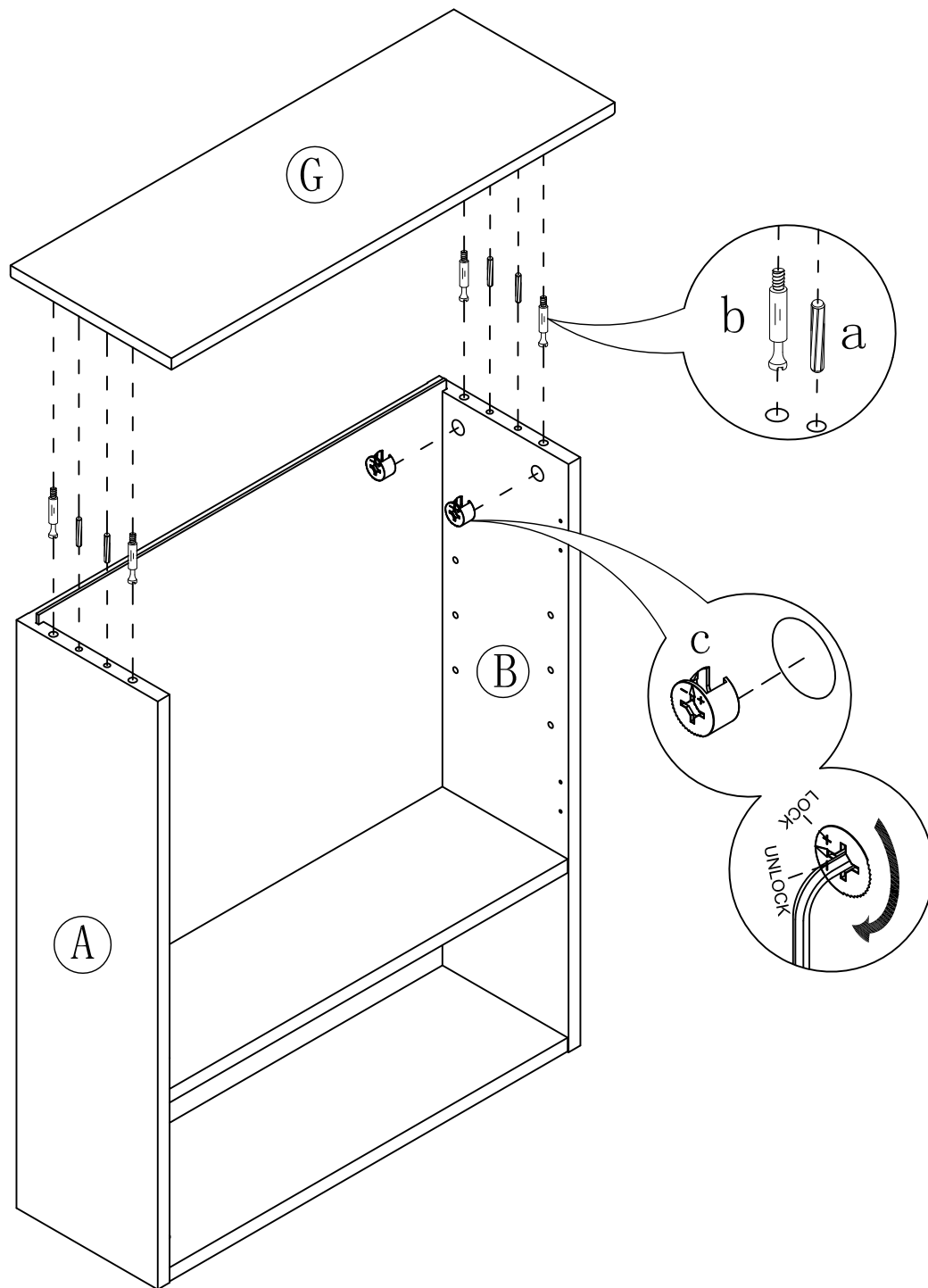

STEP 5

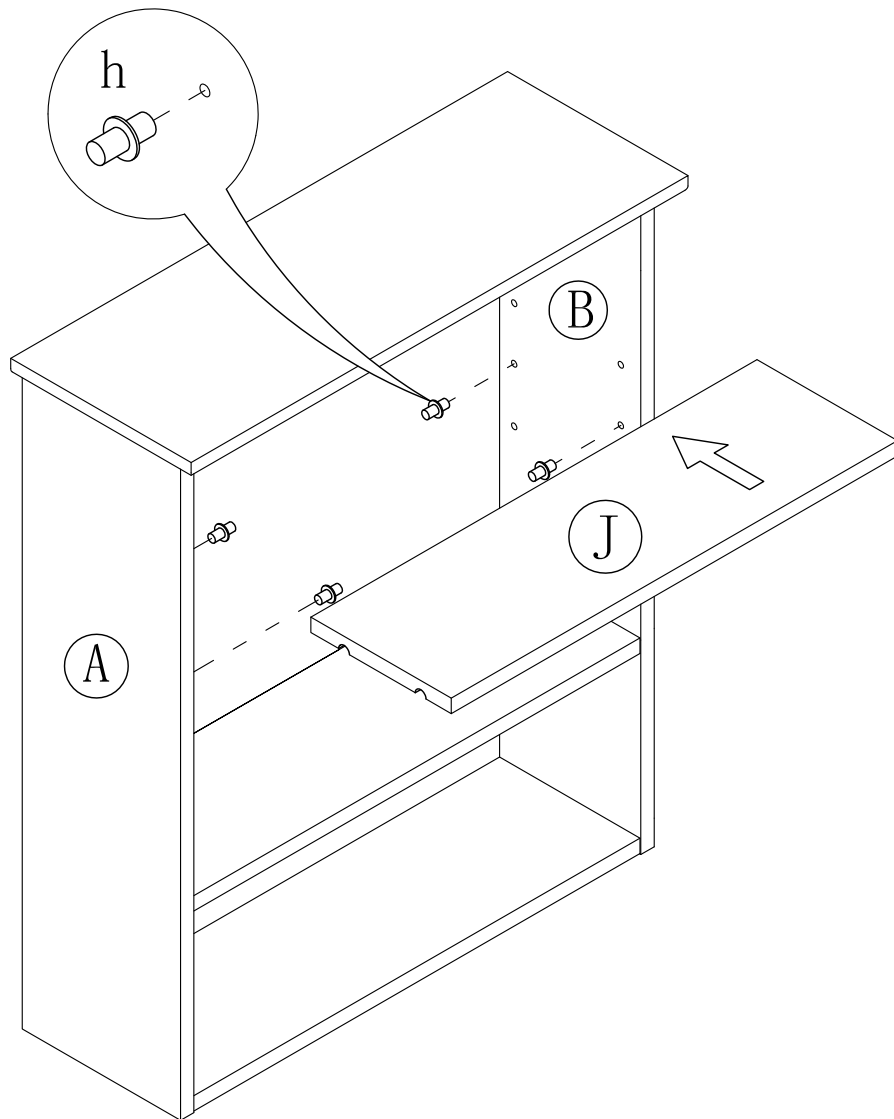

STEP 6

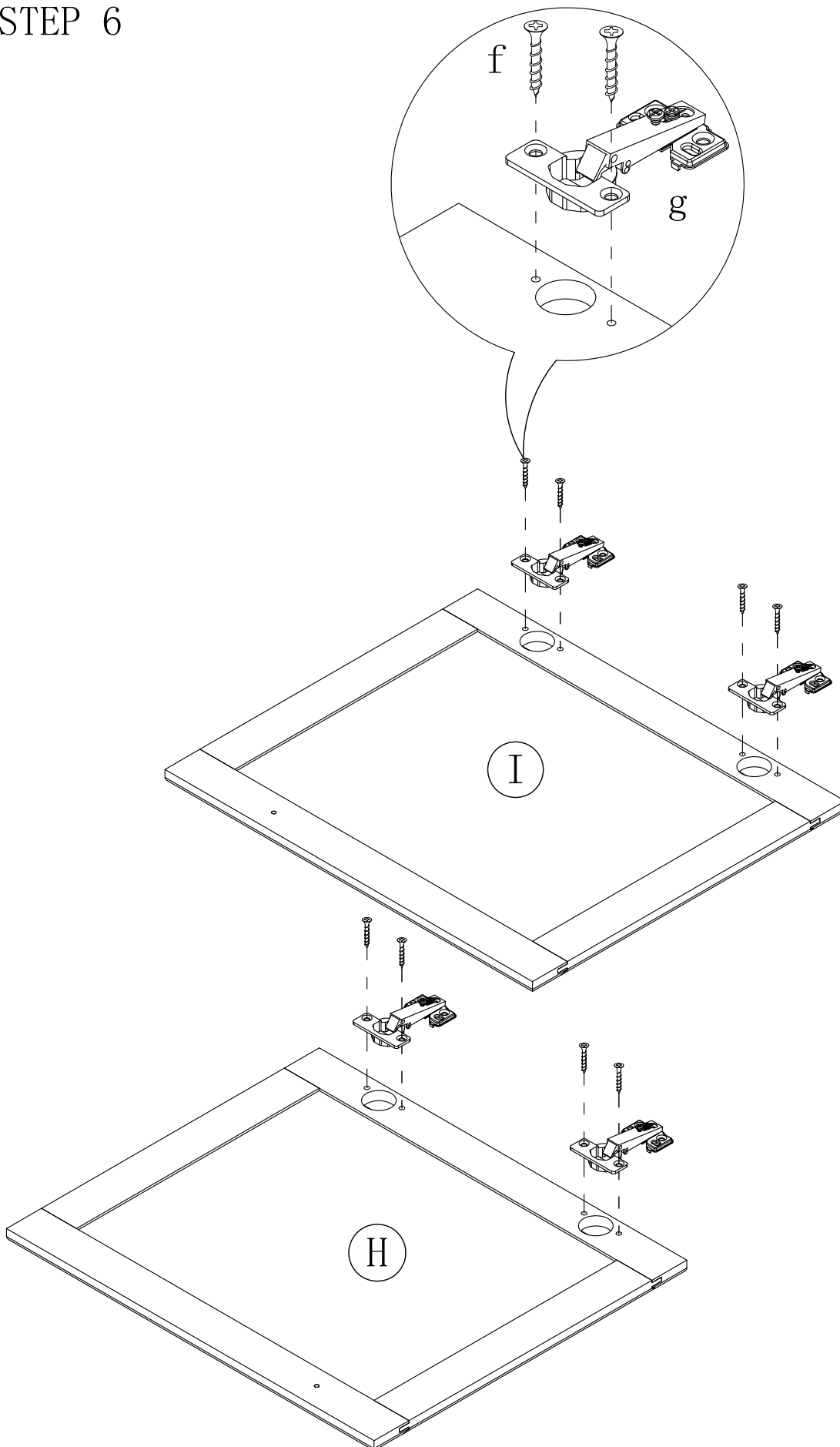

STEP 7

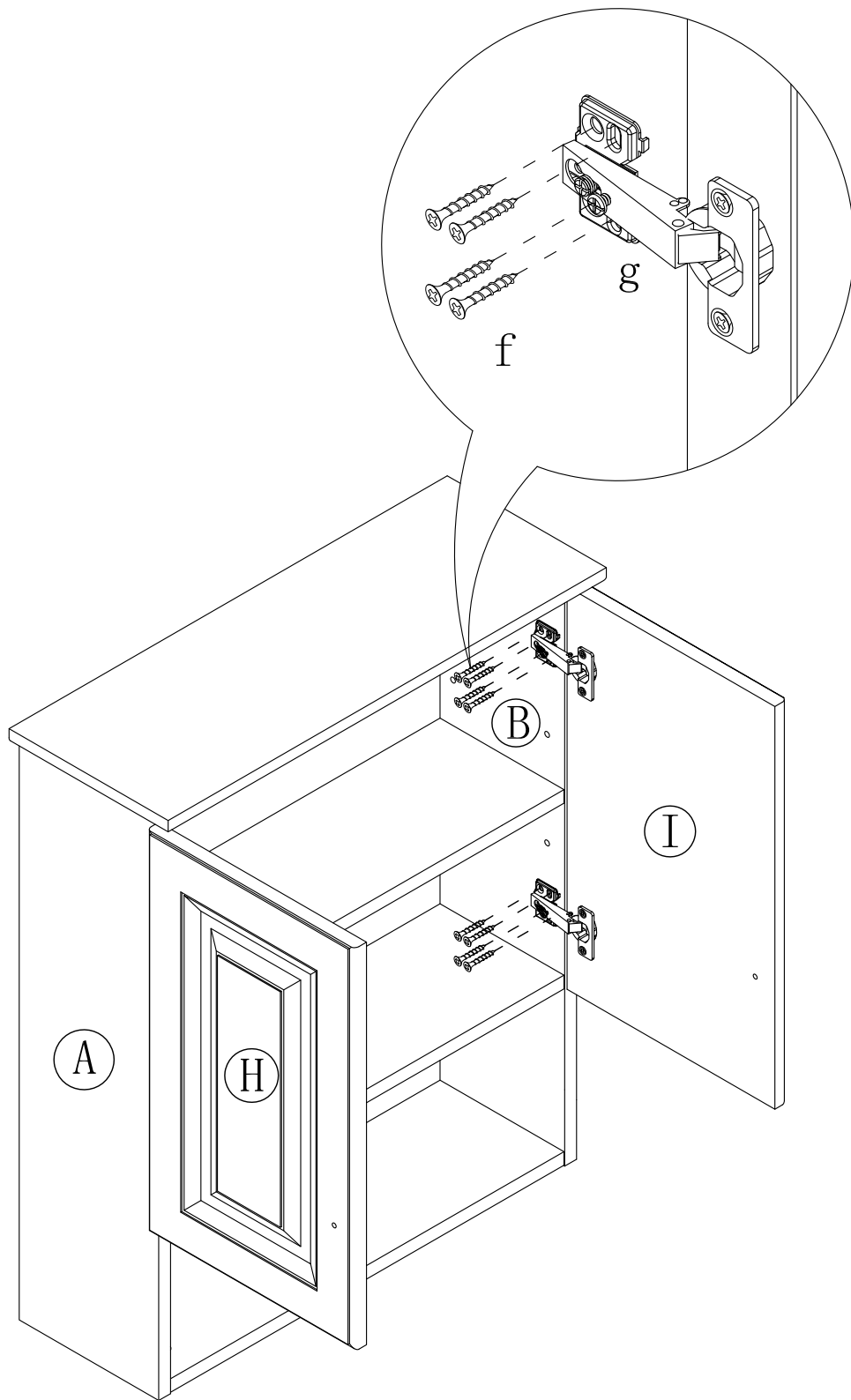

STEP 8

