

dyson airblade

The fastest, most hygienic hand dryer.

AB
02

Owner's Manual



5 year parts limited warranty
See inside for details

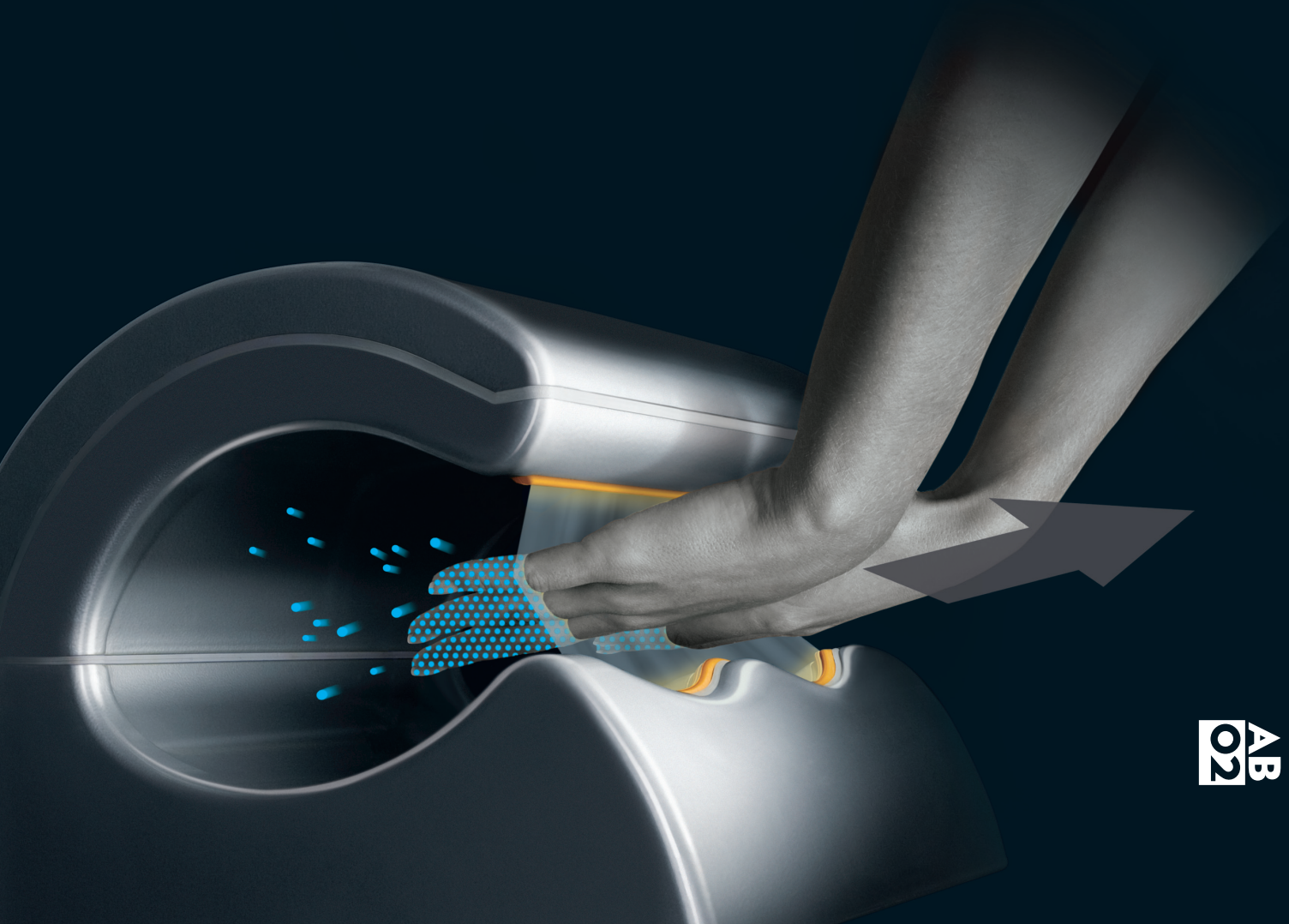

dyson airblade

1 Thank you for buying the Dyson Airblade™ hand dryer.

READ AND SAVE THESE INSTRUCTIONS IMPORTANT SAFETY INSTRUCTIONS

WARNING - TO REDUCE THE RISK OF FIRE, ELECTRIC SHOCK, OR INJURY TO PERSONS, OBSERVE THE FOLLOWING:

1. Use this unit only in the manner intended by the manufacturer. If you have questions, contact the manufacturer.
2. Before servicing or cleaning unit, switch power off at service panel and lock the service disconnecting means to prevent power from being switched on accidentally. When the service disconnecting means cannot be locked, securely fasten a prominent warning device, such as a tag, to the service panel.
3. Installation work and electrical wiring must be done by qualified person(s) in accordance with all applicable codes and standards, including fire-rated construction.
4. When cutting or drilling into wall or ceiling, do not damage electrical wiring and other hidden utilities.

Why Dyson developed the Airblade™ hand dryer

Paper towels have always been expensive, labor-intensive, and bad for the environment. Conventional hand dryers are more economical, but are notoriously frustrating to use.

Finally, a hand dryer that works properly.

The Dyson Airblade™ was engineered to be the fastest, most hygienic hand dryer available. It is also energy-efficient and cost-effective to run.

Fastest dry

The Airblade™ hand dryer dries hands differently. It uses a high velocity blade of air to literally wipe water from hands, leaving them completely dry in just 12 seconds.

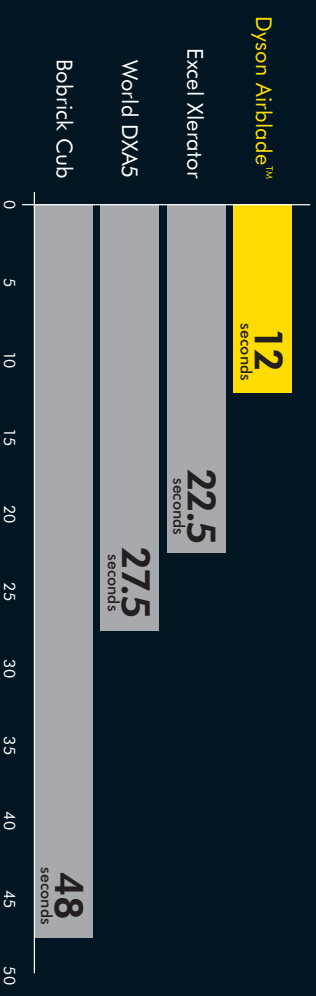

Time (seconds) to perception dry (0.1 grams moisture)

Excel Xlerator™ is the registered trademark of Excel Dryer, Inc.

World DXA5 is the trademark of World Dryer Corporation

Bobrick Cub is the trademark of Bobrick Washroom Equipment, Inc.

Cost-effective

Paper towels are very expensive to procure, stock, and dispose of. Conventional hand dryers consume large amounts of electricity.

The Airblade™ hand dryer, with a combination of high reliability, low maintenance, and energy efficiency, offers considerable cost savings throughout its lifetime. It uses up to 80% less energy than conventional hand dryers, so running costs are considerably lower. When compared to paper towels, the Airblade™ hand dryer offers operating cost savings of nearly 98%.



Uses up to 80% less energy

Conventional hand dryers rely on inefficient motor technology and high power heating elements to dry hands, often taking over 30 seconds and wasting energy.

The Airblade™ hand dryer is powered by the energy efficient 1400w Dyson Digital Motor, has no heating element, and takes only 12 seconds to dry hands. As a result, the Airblade™ hand dryer uses up to 80% less energy per drying cycle.

The most hygienic hand dryer

The Dyson Airblade™ uses a HEPA filter to remove over 99.9% of bacteria from the air used to dry hands and has antimicrobial coatings integrated into its surfaces. Only the Airblade™ hand dryer does all this.

How to use

The Airblade™ hand dryer generates a high velocity blade of air that wipes hands dry.

1. Insert your hands and the Airblade™ hand dryer will start automatically.
2. Withdraw your hands slowly upwards through the air to dry hands thoroughly in 12 seconds.

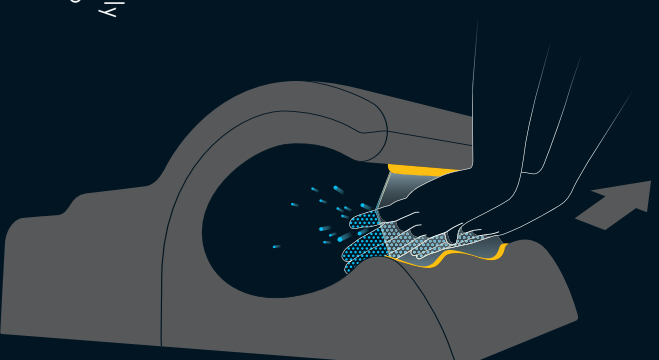

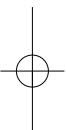

Contents

3	Glossary of Terms
4	Contents of Box
5	Installation Procedures <ul style="list-style-type: none"> • Positioning
6	<ul style="list-style-type: none"> • Removing the Fascia Cover
7	<ul style="list-style-type: none"> • Mounting Bracket and Unit
8	<ul style="list-style-type: none"> • Connecting to Electrical Supply • Refitting Front Fascia & Access Panel
9	Final Inspection
	Cleaning and Maintenance Advice
10	Troubleshooting
11-13	Limited Warranty Information
	Contacting Dyson

READ AND SAVE THESE INSTRUCTIONS

Important Safety Information

General note

The instructions contained within the Owner's Manual must be read carefully before attempting to install the Airblade™ hand dryer. Read and retain for future reference.

Failure to accurately follow the instructions may result in the incorrect operation of the Airblade™ hand dryer, damage to property and/or personal injury.

Dyson will not be held liable for any damage to property or personal injury as a result of failure to comply with the instructions contained herein.

Important Safety Information – Read before proceeding further

⚠ CAUTION: Risk of electric shock when opening aluminium case. Do not remove casing unless this unit is being serviced by a qualified service personnel. The internal components of the Airblade™ may result in electric shock to the user if the casing is removed and handled improperly. Please consult the Dyson Airblade™ Service Manual for proper servicing and care of unit.

⚠ WARNING: To reduce the risk of fire or electric shock, do not expose the internal mechanism of this unit to rain or moisture.

All electrical installation and repair work must be conducted and carried out in accordance with all federal, state and local codes and regulations.

The Airblade™ hand dryer must be grounded.

Disconnect power before installation or servicing.

Dyson recommends the use of protective clothing, eyewear and materials as necessary.

Check that the electrical supply will correspond with the rating on the rating plate located on the lower left side of the unit.

Trouble free operation and safety can only be continued by using genuine Dyson spare parts.

Do not use Airblade™ hand dryer for anything other than drying hands.

WARNING

This product may contain substances known to the state of California to cause cancer, birth defects and other reproductive harm. Wash hands after handling.

Dyson Airblade™ hand dryer

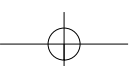

Glossary of Terms

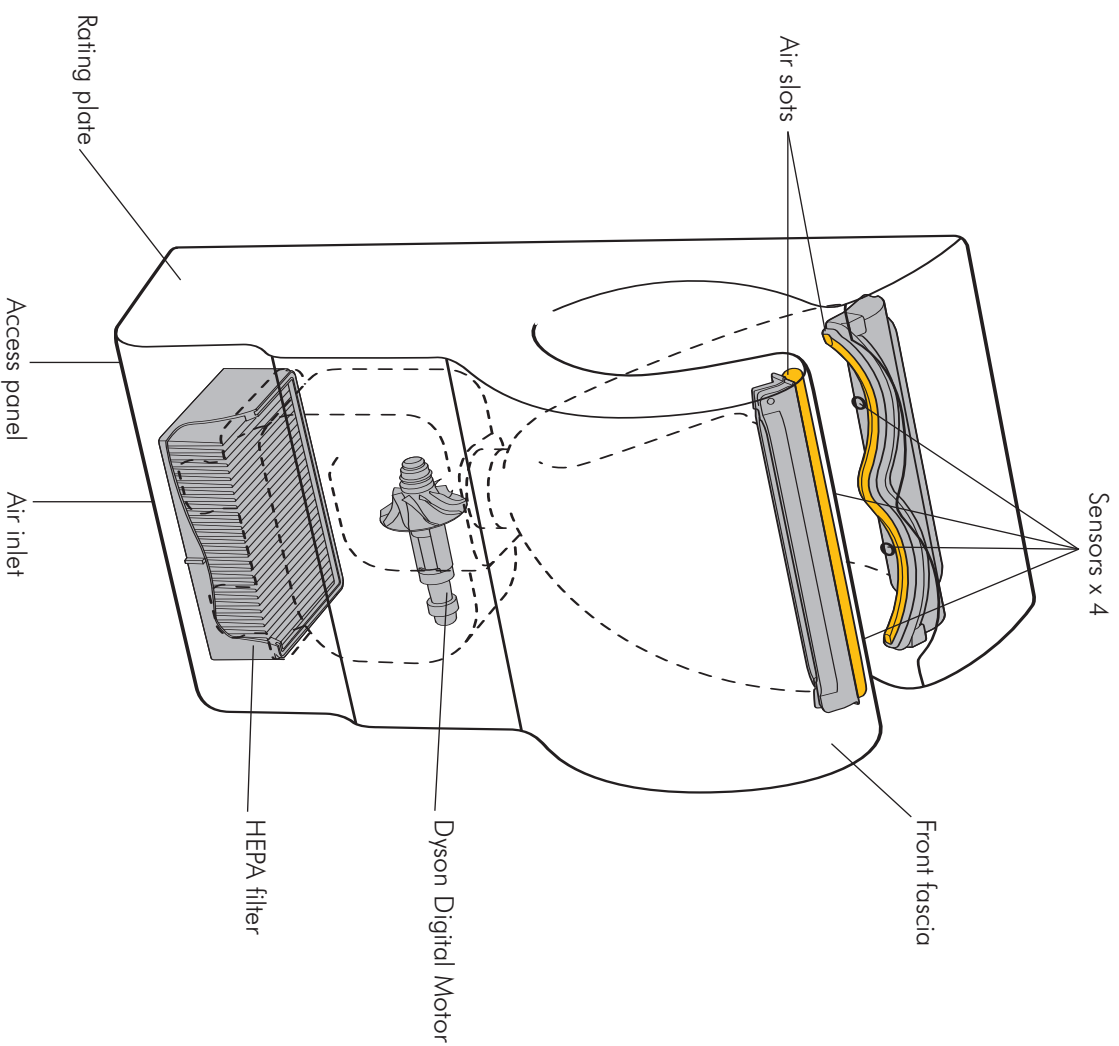

Contents of Box

Dyson Airblade™ hand dryer

Information pack containing:

- Owner's Manual including warranty information
- Registration information and reply envelope
- Mounting Template
- Tamper proof service tool
- Mounting bracket

To install the Airblade™ hand dryer you will need:

Electric drill

#2 Phillips screwdriver

Level

Tamper proof service tool – (supplied with unit)

(6)-Toggle or masonry bolts and appropriate fittings
(Recommended minimum size of 1/4")

Electrical requirements:

120 volt, 60 Hz, AC-only, 15 amp minimum
fused electrical supply

We recommend:

A separate circuit

A time delay fuse or circuit breaker

Note: Please contact a qualified electrician so that the installation conforms to all federal, state and local codes and regulations.

If you have any questions on the installation please call our Dyson Helpline toll free at 1-888-DYSON-AB

Dyson Airblade™ hand dryer

Installation Procedures

5

⚠ WARNING: Before beginning any installation work you must confirm the following:

- Make sure that the electrical supply has been disconnected or switched off before attempting installation to avoid the risk of electrical shock or electrocution.
- Ensure no pipe work (gas, water, air) or electrical cables, wires or ductwork are located directly behind the drilling area.
- It is recommended that at least two of the six mounting anchors for the unit be fastened into a wall stud or support.

Positioning

Position the mounting template provided on the wall where the Airblade™ hand dryer is to be situated.

Recommended heights are shown in **Fig 1** but height may need to be adjusted for each individual installation.

Ensure that the electrical cable is of sufficient length to make the necessary connection to the backplate and that the wires are an additional 24" in length to reach the terminal block.

Mark the 6 mounting holes for mounting the unit, and the 7th for the electrical entrance.

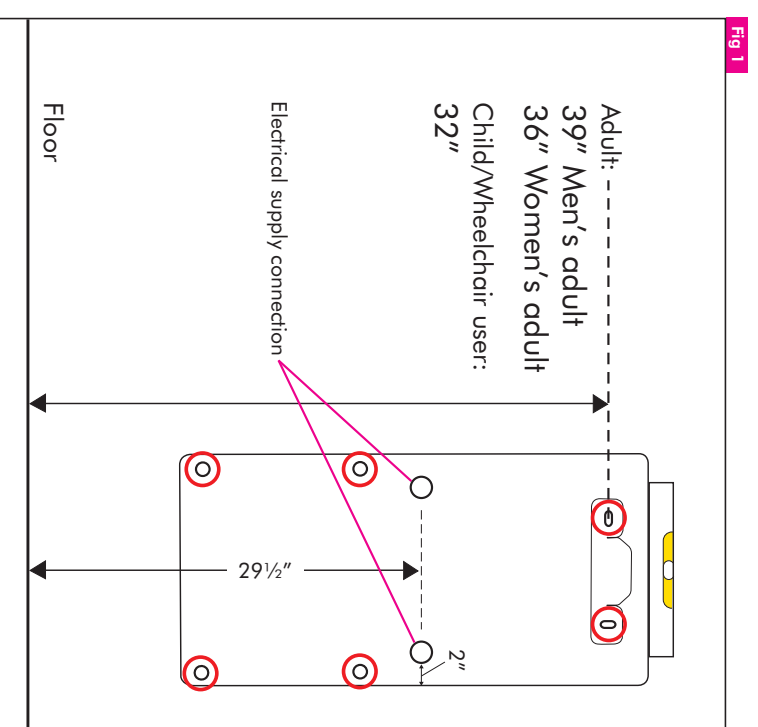

Dyson Airblade™ hand dryer

Installation Procedures

Removing the Fascia Cover



WARNING:

Metal casing may have sharp edges. Use caution in removing all screws as not to strip them.

Place the Airblade™ hand dryer face up on a dry and clean work surface to protect the product and the property from damage.

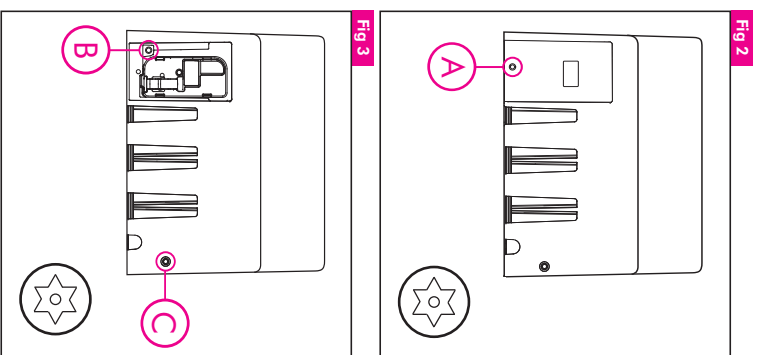

Remove the (5) tamper proof screws from the unit in the sequence illustrated in **Figs 2-4** with the provided tamper proof service tool.

Fig 2 - Remove the tamper proof screw from location **A** at the bottom left side Access panel and remove.

Fig 3 - Remove the tamper proof screw on the bottom left and bottom right sides as illustrated at **B** and **C**.

Fig 4 - Remove the (2) tamper proof screws from the inner section of the fascia panel at location **D** and **E**.

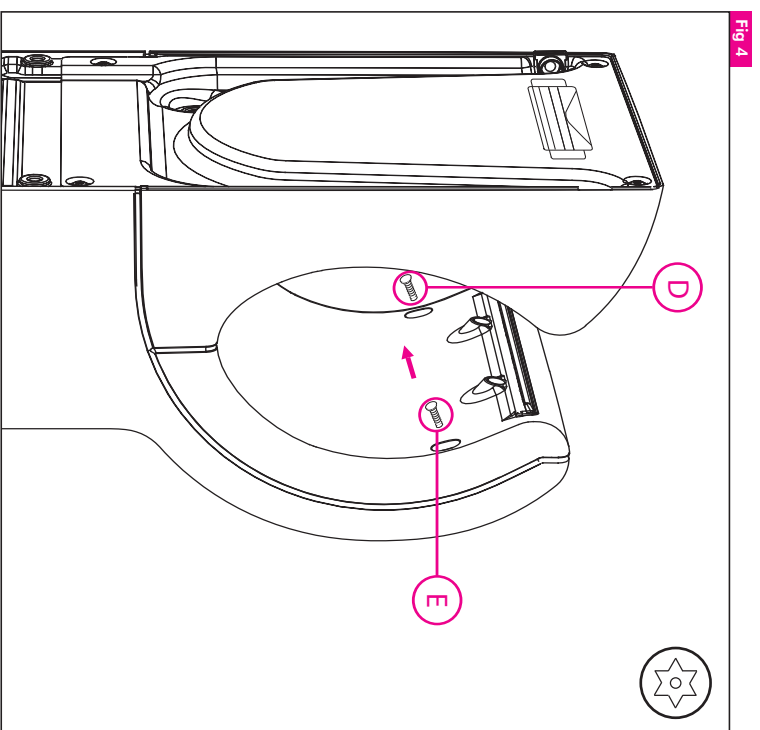
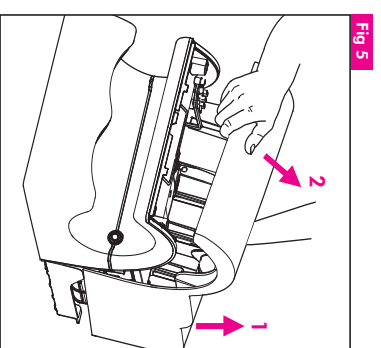

Fig 5 - Grab the fascia panel near the bottom and lift upward, tilting the panel up until it unclips from the lip.



Installation Procedures

Mounting Bracket and Unit

7
Ensure that marks are level and in the correct location, then drill holes for the mounting bracket.

Securely fasten the mounting bracket to the wall.

Drill the four remaining holes that will be used to anchor the Airblade™ hand dryer to the wall as highlighted in Fig 7.

Hang the unit on the secured mounting plate according to Fig 6 and then fasten the unit to the wall through the 4 holes in the lower section of the unit illustrated in Fig 7.

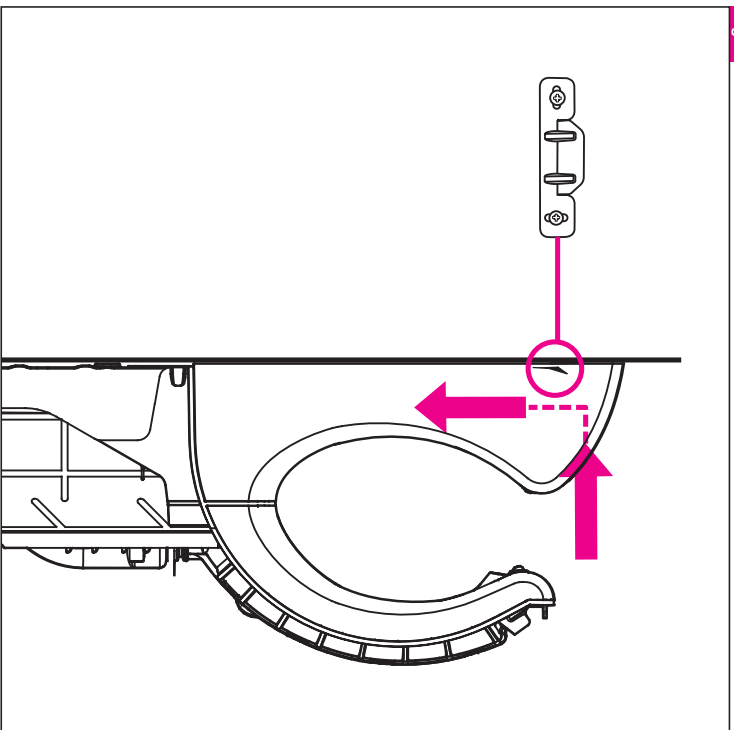

Fig 6

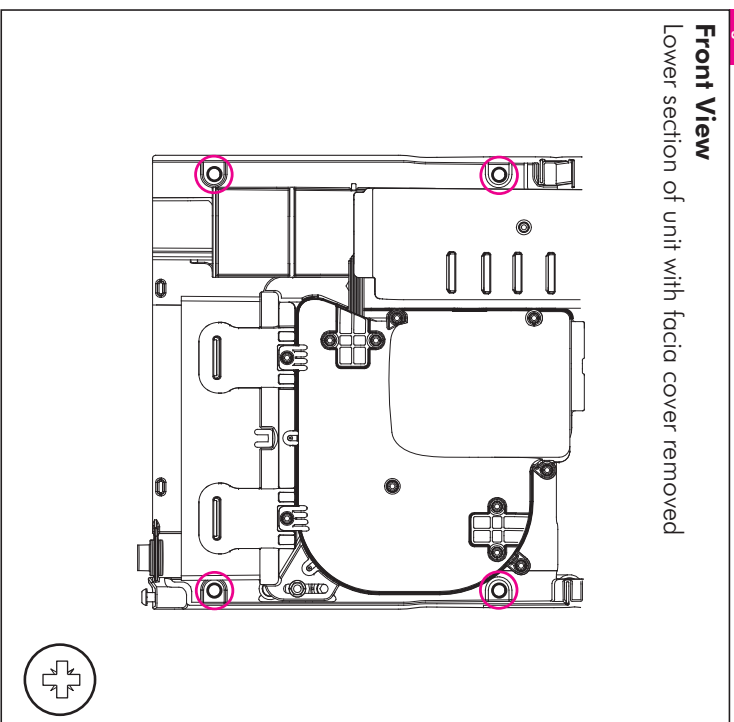

Fig 7

Front View

Lower section of unit with fascia cover removed

Dyson Airblade™ hand dryer

Installation Procedures

Connecting to the Electrical Supply

- ⚠ CAUTION:** Risk of electric shock when opening aluminium case. Do not remove casing unless this unit is being serviced by a qualified service personnel. The internal components of the Airblade™ may result in electric shock to the user if the casing is removed and handled improperly.
- ⚠** Please consult the Dyson Airblade™ Service Manual for proper servicing and care of unit.
- ⚠ WARNING:** To reduce the risk of fire or electric shock, do not expose the internal mechanism of this unit to rain or moisture.

Make sure that all connections are made in accordance with federal, state and local codes and regulations.

Make sure that the incoming cable and/or connectors are secured to the back plate in the location illustrated in **Fig 8**.

Refitting Front Fascia Panel & Access Panel

Once secured, ensure that there is enough wire to reach the terminal block.

Secure the Live, Neutral and Ground wires into the proper terminal block locations. Re-establish power to the unit and test for proper voltage.

Attach the front fascia panel back on by latching the top clip first onto the unit and then pivoting the fascia cover downward until flush.

Install the bottom left and right tamper proof screws back into the machine using the supplied tool.

Install the (2) tamper proof screws back into the inner section of the fascia panel.

Re-install the Access panel and (1) tamper proof screw.

Fig 8

View from Back

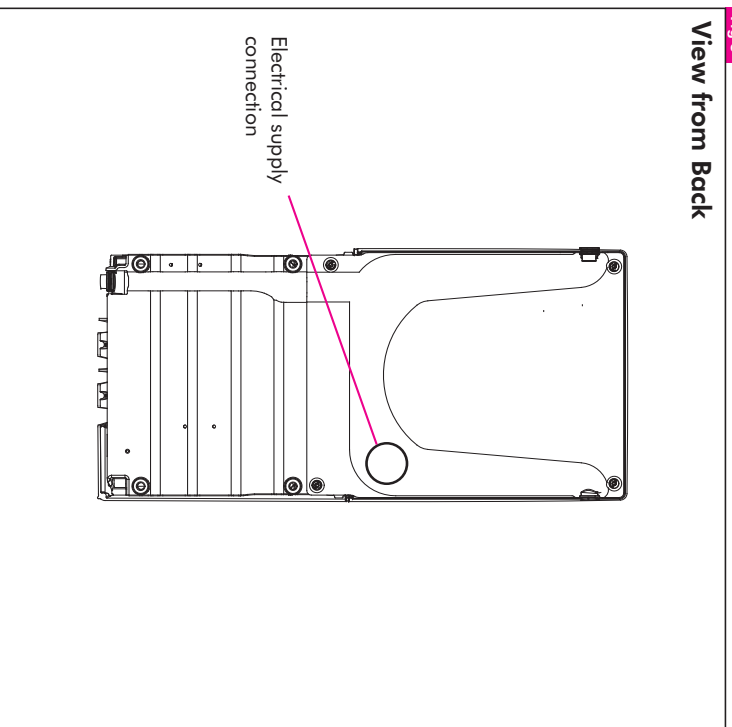

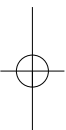

Final Inspection

Inspection Advice

9 Ensure that machine turns on when hands are placed inside the Airblade™ hand dryer. Please register your product information with us.

- You may send in the completed registration card in the provided pre-paid envelope.
- Call our Dyson Helpline toll free at 1-888-DYSON-AB
- Visit us on the web at www.dysonairblade.com

Cleaning and Maintenance Advice

Cleaning Advice

Surfaces

Make sure that all surfaces of the Airblade™ hand dryer are cleaned regularly with a soft cloth and non-abrasive, non-caustic cleaning fluid.

Maintenance Advice

Air Inlet

Regularly check at the base of the Airblade™ hand dryer to ensure that it is free from dust and debris. If the air inlet gets dirty simply remove dust or debris with a dry cloth or vacuum.

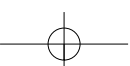
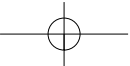

Dyson Airblade™ hand dryer

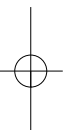

Troubleshooting

Important: Turn off power before troubleshooting

Note: Please try and have model & serial number available before making call. The model/serial plate is located on the left, lower side corner of the unit.

Problem	Action	If Problem Persists
The Airblade™ hand dryer fails to start.	Check to make sure the unit is connected to correct power supply, and that it is turned on.	Call Dyson Helpline at 1-888-DYSON-AB
The Airblade™ hand dryer is turning on and off erratically.	Check sensor lenses are clean.	Call Dyson Helpline at 1-888-DYSON-AB
The Airblade™ hand dryer sometimes cuts out when in use, but resumes operation after a period of time.	Check the air inlet at the base is clean and free of dust. If the air inlet is dusty, simply remove dust with dry cloth or vacuum cleaner.	Call Dyson Helpline at 1-888-DYSON-AB
Air is coming out of the front or back of unit.	Check for and remove any obstructions.	Call Dyson Helpline at 1-888-DYSON-AB

This product is protected by the following Intellectual Property Rights Patent/Patent Application Nos:

GB 0515750.8 GB 0600872.6 GB 0600537.5 GB 0600868.4 GB 0602465.7 GB 0600534.2 GB 0600869.2 GB 0515749.0 GB 0600879.1
 GB 0515741.7 GB 0515754.0 GB 0600536.7 GB 0515744.1 GB 0600881.7 GB 0515739.1 GB 0600880.9 GB 0515752.4 GB 0602075.4
 Equivalent patents, registered designs and applications exist in other countries

NSF Protocol 335 Hygienic Commercial Hand Dryers

Limited Warranty Information

Limited 5 Year Parts Warranty

11

- **5 year parts limited warranty**
- **Additional 1st year labor limited warranty**
- **Dedicated Dyson helpline**
- **Nationwide field service coverage**

The full terms and conditions of the Dyson limited warranties are described on the following pages.

Thank you for choosing to buy a Dyson.

If you have a question about the Dyson Airblade™ hand dryer, please call Dyson Helpline at **1-888-DYSON-AB** with your serial number and purchase information. Your serial number can be found on the serial plate, located at the lower left side of the unit. Most of the time problems can be handled over the phone by our trained technical support staff. If service is required (which may include replacing a defective part), our staff will coordinate and discuss options to have your machine serviced by Dyson or its authorized agent. If your machine is covered under warranty, and the repair is covered, Dyson will provide replacement parts at no cost to the unit owner (which can be installed by Dyson or its authorized agents for additional costs at prevailing rates) for a period of 5 years from date of purchase (or date of delivery, whichever is later).

Dyson Airblade™ hand dryer

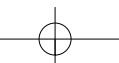

In addition, during the 1st year, this warranty provides at no extra cost to unit owner all the labor necessary to ensure that your Dyson Airblade™ hand dryer is in proper operating condition. All repair work pursuant to this warranty must be carried out by Dyson or its authorized agents. Repairs or replacement of your Dyson Airblade™ machine under any Dyson warranty will not extend the period of any warranties herein. The product owner is responsible for securing access to the product. Any parts replaced or removed by Dyson or its authorized agents during the first year will become the property of Dyson.

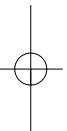

Limited Warranty Information

Please register your product with us.

There are 3 ways to do this.

- You may fill out and send in the completed pre-paid registration card
- Call our Dyson Helpline toll free at **1-888-DYSON-AB**
- Visit us on the web at **www.dysonairblade.com**

This will confirm ownership of your Dyson Airblade™ hand dryer in the event of an insurance loss and enable us to contact you if necessary.

Example of rating plate



Your serial number can be found on the rating plate.

Note your serial number for future reference:

5 Year Parts Limited Warranty

All factory parts of your Dyson Airblade™ hand dryer are warranted against original defects, material and workmanship when used in accordance with the Owner's Manual for a period of 5 years.

The 5 year parts limited warranty commences on the date of purchase (or on the date of delivery, whichever is later).

The 5 year parts limited warranty will expire on the fifth anniversary of its commencement. The unit owner must provide proof of purchase before any replacement parts will be provided for repair pursuant to this warranty. Without this proof of warranty, the owner is liable to pay for any parts on the product by Dyson or its authorized agents at the prevailing rate. All functional factory replacement parts can be installed by Dyson or its authorized agents for additional costs at the prevailing rates.

Additional 1st Year Labor Limited Warranty

This warranty commences on the date of purchase (or on the date of delivery, whichever is later). The 1 year labor limited warranty will expire on the 1st anniversary of its commencement. In addition, during the 1st year, this warranty provides at no extra cost to unit owner all the labor necessary to ensure that your Dyson Airblade™ hand dryer is in proper operating condition. All repair work pursuant to this warranty must be carried out by Dyson or its authorized agents. Any labor charges involved with defective replacement parts after the 1st year labor limited warranty expires are the sole responsibility of the product owner.

Limited Warranty Information

13

The 5 year parts limited warranty and the additional 1st year labor limited warranty are subject to the following:

What is not covered by the 5 year parts limited warranty or the 1 year labor limited warranty.

Dyson B2B, Inc. shall not be liable for costs incurred as a

result of:

- Machines purchased from an unauthorized dealer.
 - Accidental damage, faults caused by negligent use or care, misuse, neglect, careless operation or handling of the machine which is not in line with the Dyson Airblade™ Owner's Manual.
 - Use of parts not in accordance with the Owner's Manual of the Airblade™ hand dryer.
 - Blockages, other than those caused by soap and water in normal use. In case of other types of blockages please refer to the Troubleshooting section of the Owner's Manual or call the Dyson Helpline for advice.
 - External sources such as weather.
 - Repairs or alterations carried out by unauthorized parties or agents.
 - Faulty installation except where installed by Dyson B2B, Inc. or an authorized agent.
 - Use of parts and/or accessories other than those produced, assembled, installed or recommended by Dyson B2B, Inc. or an authorized agent.
- If you have any doubts as to what is covered by your warranties, please call the Dyson Helpline at **1-888-DYSON-AB**.

Warranty Service

- Please fill out and return the Product Registration Form, or register on line at www.dysonairblade.com or call the Dyson Helpline at **1-888-DYSON-AB**.

Dyson Airblade™ hand dryer

- Before any service can take place, the terms of both warranties require that you contact the Dyson Helpline with your serial number, and the date of purchase or delivery (which ever comes later).
- Please keep your purchase receipt or information in a safe place to ensure that you have this information available.
- All covered repair work will be carried out by Dyson B2B, Inc. or its authorized agents.
- Any replaced defective parts will become the property of Dyson B2B, Inc. during the first year.
- Service under the warranties (which may include replacing a defective part) will not extend the period of any warranty.
- If your machine is not functioning properly, please call the Dyson Helpline at **1-888-DYSON-AB**. Most issues can be resolved over the telephone by our trained helpline and technical support staff. If this is not possible, Dyson B2B, Inc. will arrange for your Dyson Airblade™ to be repaired pursuant to the terms of the Dyson Airblade™ warranties.

Other Limitations and Exclusions of Warranties

- Any implied warranties by the Dyson Airblade™ hand dryer, including but not limited to warranty of merchantability or warranty of fitness for a particular purpose, are limited to the duration of this warranty. This limitation is not allowed by some states and so this limitation may not apply to you.
- Your remedy for breach of the warranties are limited to the warranties described above. Dyson B2B, Inc. will not be liable for any consequential damages or incidental damages you may incur in connection with your purchase and use of your Dyson Airblade™ hand dryer. This limitation is not allowed by some states and so this limitation may not apply to you.
- These warranties give you specific legal rights. You may have other rights which may vary by state.
- These warranties are not transferable.

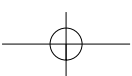
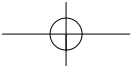
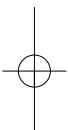

Dyson Airblade™ hand dryer



Contacting Dyson

Dyson Helpline can be contacted by calling
1-888-DYSON-AB

When calling the Dyson Helpline, please make sure you have the serial number and the purchase date of the Airblade™ hand dryer ready. The serial number can be found on the warranty registration information enclosed or the serial plate located on the lower left side of the unit.

Limited Warranty Information

The Airblade™ hand dryer is covered by a
5 year parts limited warranty and an additional 1st year
labor limited warranty.

See enclosed warranty registration information for details.

You can register your warranty online at
www.dysonairblade.com
or by calling **1-888-DYSON-AB**

For further information about what is included in the
Dyson 5 year parts limited warranty and an additional 1st year
labor limited warranty, please visit
www.dysonairblade.com