Patio Heater

Model: PH01-S PH01-SS
Item number 60763



WARNING: For outdoor use only.

FOR YOUR SAFETY

If you smell gas:

1. Shut off gas to the appliance.
2. Extinguish any open flame.
3. If odor continues, immediately call gas supplier.

FOR YOUR SAFETY

Do not store or use gasoline or other flammable vapors or liquids in the vicinity of this or any other appliance.

PLEASE retain this manual for future reference.



CERTIFICATE TO
ANSI 83.26a-2008
CONFORM TO CSA
2.37a-2008

3177588
Intertek

Instruction Manual & Parts List

INSTALLER: Please leave this manual to the consumer.

CONSUMER: Please retain with this manual for future reference.

Manufacturer: Changzhou Wellife Furnace Co., Ltd.

Tools and parts needed for assembly



DANGER



CARBON MONOXIDE HAZARD

This appliance can produce carbon monoxide which has no odor.

Using it in an enclosed space can kill you.

Never use this appliance in an enclosed space such as a camper, tent, car or home.

WARNING: Improper installation, adjustment, alteration, service or maintenance can cause injury or property damage. Read the installation, operating and maintenance instructions thoroughly before installing or servicing this equipment.

WARNING :

For Outdoor Use Only

LPG cylinders to be used must be constructed and marked in according with US DOT specifications. Storage of the heater indoors is permissible only if the LPG cylinder is turned off and removed.

NOTE:

Use only 20lb LPG tank with size of 18.1in/46cm Height x 12.5in/32cm Width.

Do not use if the environment temperature is below 40 degrees F / 4.4 degrees C.

Tools needed:

- Open end wrench 10 & 13mm (included)

NOT included:

- Adjustable opening wrench 8" long
- Slip joint 9" long
- Philips screwdriver with medium blade
- Spray bottle of soap solution for leak testing

NOTE: PLEASE READ THE FOLLOWING SAFETY RULES WARNING:

This heater must only be used outdoors. Using this product in an enclosed area may cause injury, death or property damage.

Only use in a well-ventilated space. Do not use in a building, garage, or any other enclosed area.

Read the instructions before use. This heater must be installed in accordance with local codes or, in the absence of local codes, with the National Fuel Code, ANSI Z223.1. If applicable, the heater, when installed, must be electrically grounded in accordance with local codes or, in the absence of local codes, with The National Electrical Code, ANSI/NFPA70.

Do not use the heater in an explosive atmosphere. Keep the heater away from areas where gasoline or other flammable liquids or vapors are stored.

Prior to use, check for damaged parts such as hoses, regulators, pilot or burner.

Turn off and disconnect the LPG cylinder before moving the heater.

Do not attempt to alter this heater in any manner. EXAMPLE: Using the heater without the top canopy reflector or radiant screen.

Do not shorten the burner post assembly.

Do not use the heater in basements or below ground level. It must always be placed on a solid and level surface.

Always ensure there is ample fresh air ventilation. This heater is for outdoor use ONLY.

Never replace or substitute the regulator with any regulator other than the factory suggested replacement.

Do not clean the heater with cleaners that are combustible or corrosive.

Do not paint radiant screen, control panel or top canopy reflector.

All leak tests should be done with a soapy solution. NEVER USE AN OPEN FLAME TO CHECK FOR LEAKS.

The LPG cylinder should be turned off when the heater is not in use.

At least once a year, the unit should be inspected for the presence of spiders, spider webs or other insects.

PRECAUTIONS

CHECK THE HEATER IMMEDIATELY IF ANY OF THE FOLLOWING EXIST:

1. The smell of gas in conjunction with extreme yellow colored tips of the burner flames.
2. The heater does not reach temperature.
3. The burner makes a popping noise during use (a slight popping noise is normal when the burner is extinguished after using).

Children and adults should be aware of the hazards of high surface temperature and should stay away to avoid burns or clothing ignition.

Young children should be carefully supervised when they are in the area of the heater.

Clothing or other flammable material should not be hung from the heater or placed on or near the heater.

Any guard or other protective device removed for servicing the heater must be replaced prior to operating the heater.

Installation and repair should be done by a qualified service person. The heater should be inspected before use and cleaning may be required at least once a year, or as necessary. It is imperative that the control compartment, burner, and circulating passageways of the heater are kept clean.

Keep the heater area clear of combustible materials such as gasoline and other flammable vapors and liquids.

Do not obstruct the flow of combustion and ventilation air.

Keep the ventilation opening of the LPG cylinder enclosure free and clear of debris.

Storage of the heater indoors is permissible only if the LPG cylinder is turned off, disconnected, and removed from the heater.

Cylinders must be stored outdoors in a well-ventilated area out of the reach of children. Disconnected cylinders must have threaded valve plugs tightly installed, and must not be stored in a building, garage, or any other enclosed area.

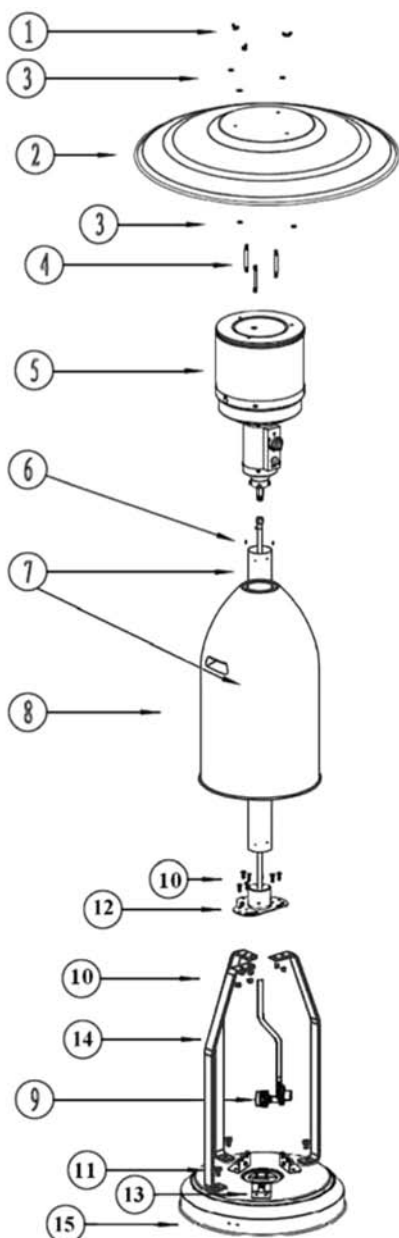

1. 3 pcs castle nuts
2. Reflector
3. 6 pcs 8mm washers for pins support
4. 3 pcs 90mm (L) pins for reflector support
5. Head assembly
6. 4 pcs M6x10mm bolts
7. 2 pcs Post assembly
8. Tank housing
9. Regulator
10. 6 pcs M6x30mm bolts and 6mm nuts for connection of post support and support legs
11. 3 pcs M8x16mm bolts for connection of support legs and base
12. Post support
13. 6 pcs M6x12mm bolts for connection of LPG cylinder fixed parts with base
14. 3 pcs. Support legs
15. Base
16. 1 pcs open end wrench (10&13mm)
17. Wheel assembly



17

ATTACHING WHEEL ASSEMBLY

Step 1

- 1-1. Locate Wheel Assembly (17) and 2 nuts/bolts contained in plastic bag with Wheel Assembly (Fig. 1).

Fig. 1



Step 2

- 2-1. Turn Base (15) so that holes for attachment of Wheel Assembly are facing you (Fig. 2).

Fig. 2

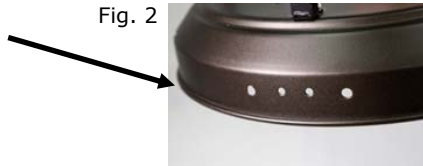

- 2-2. Align holes in Wheel Assembly (17) with holes on Base (15) (Fig. 3). Insert bolts through both sets of holes and secure nuts on end of bolt (Fig. 4).

Fig. 3



Fig. 4



Step 3

- 3-1. Wheel Assembly (17) should now be attached to Base (15) as shown (Fig. 5).

Fig. 5



WARNING: This appliance requires installation by a competent person. Proper assembly is the responsibility of the installer.

Step 1

- 1-1. Attach 3pcs LPG cylinder fixed parts on the base with 6pcs M6x12mm bolts.
- 1-2. Position the 3 pcs support legs on the base as shown in the picture to the right.
- 1-3. Use 3 pcs M8x16mm bolts to affix the support legs to the base.

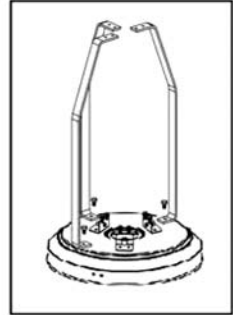

Step 2

- 2-1. Put the post support on top of the 3 pcs support legs.
- 2-2. Use 6 pcs M6x30mm bolts and 6mm nuts to connect the post support and support legs.
- 2-3. Use 4 pcs. M6X10mm bolts to connect the first piece of the post assembly to the post support.

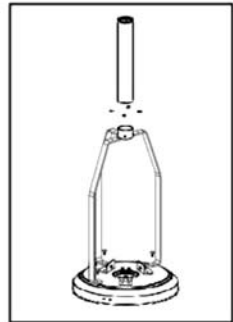

Step 3

- 3-1. Connect the second piece of the post assembly to the first piece of the post assembly and screw on clockwise.

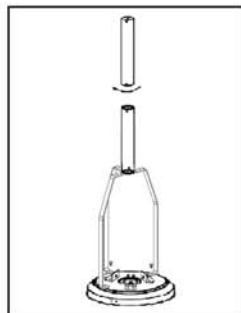
**Step 4**

- 4-1. Place the tank cover on the base.

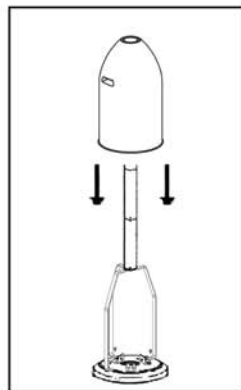
**Step 5**

- 5-1. Secure the 3 pcs 90mm pins(reflector support bolts) on the cap of emitter screen.
- 5-2. Route the gas hose up through the post and out of the top.
- 5-3. Connect the gas hose to the gas burner inlet connector. Use 2 wrenches to screw the gas hose and connector together tightly.
- 5-4. Fix the head unit collar to the post with 4 pcs M6x10mm bolts.

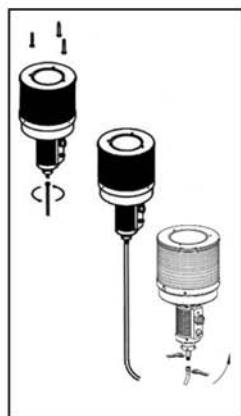

PRECAUTIONS

Reflector (#2) is comprised of 3 – outer pieces and 1 – center piece. Locate all 4 pieces of Reflector (#2) which are wrapped in bubble wrap. Unwrap and remove all pieces and peel off the protective blue plastic on each piece. Locate 9 bolts and 9 cap nuts in the plastic bag. Align the 3 – outer pieces with the 1 – center piece and place a bolt through the center hole on each piece as shown below. Tighten castle nut on each bolt.

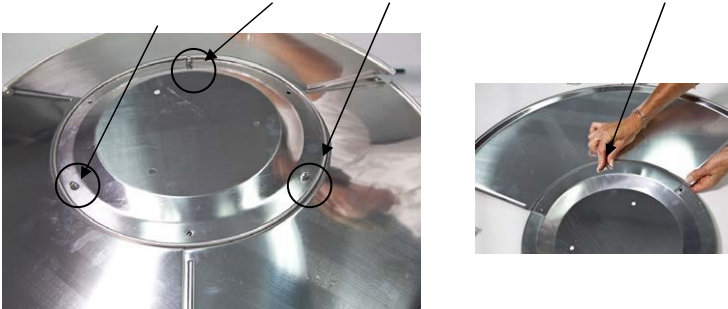

Next, align the sides of each outer piece and the center piece and insert the next 3 bolts through both holes. Tighten castle nuts on bolts.

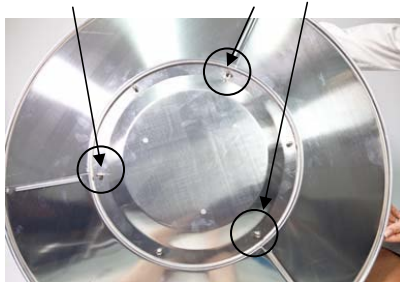

Finally, insert bolt through holes located at outside edge of adjoining panels of the reflector side pieces (3 bolts required) and tighten castle nuts on bolts.



Step 6

- 6-1. Put 8mm washer on each reflector support bolt.
- 6-2. Fasten the reflector with 3 pcs washers and 3 pcs M8 mm castle nuts.

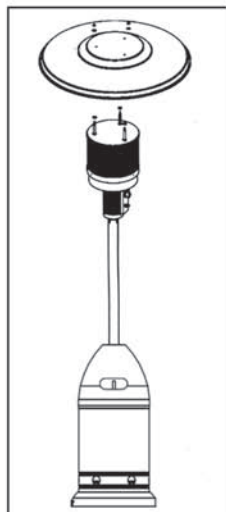
**Step 7**

- 7-1. Lift the tank cover and rest it on the post flange.
- 7-2. Connect the other end of gas hose with regulator to the gas cylinder and tighten.

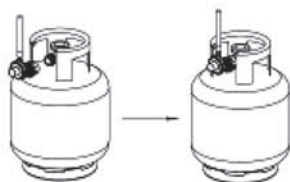

Warning: When connecting the gas cylinder and regulator, make sure the connection is tight and always check for any leaks. Please see page 9 "Check for Leak" for full instructions.

- 7-3. Put gas cylinder on the stand.



- 7-4. Lower tank over gas cylinder and down to cover base.

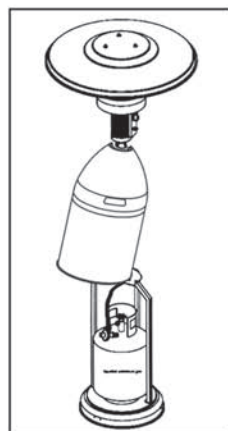

Check for Leak

Your patio heater has been checked at all factory connections for leaks, but you should always check when you attach the LPG cylinder. To check for leaks, follow these instructions:

- Assemble all gas connections;
 - Connect regulator assembly to the propane tank;
 - Make sure the heater valve is turned OFF.
- 1) Make soapy solution by mixing 1 part liquid dish soap and 3 parts water.
 - 2) Open the propane tank valve.
 - 3) Spoon several drops (or use squirt bottle) of the soapy solution onto the gas hose /regulator and regulator/cylinder connection.
 - 4) Inspect the connections and look for bubbles.
 - 5) If no bubbles appear the connection is safe.
 - 6) If bubble appears, there is leakage. Close the propane tank valve, and loosen and re-tighten this connection.
 - 7) Check for leakage again.

- 8) If bubbles still appear, close the propane tank valve and contact your gas supplier. If a leak is detected, **DO NOT** attempt to use the heater.

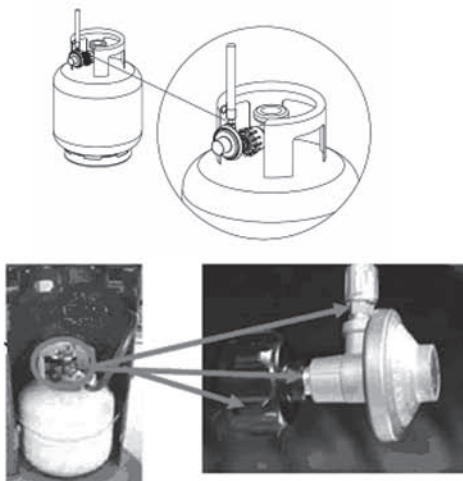

MAKE SURE to check all THREE connections between the cylinder and gas line.

NOTE:

- 1) The cylinder must be provided with a shut off valve terminating in a LPG supply cylinder valve outlet specified, as applicable, for connection NO 510 in the standard for compressed gas cylinder valve outlet and inlet connections, ANSI/CGA-v-1.
- 2) The cylinder supply system must be arranged for vapor withdrawal.
- 3) The cylinder used must include a collar to protect the cylinder valve.

Annually check operation:

- A. Lift the tank housing up above the LPG cylinder and rest it on the support leg assembly.
- B. Open the propane tank valve.

- C. Spoon several drops(or use squirt bottle)of the solution onto gas hose connection and pilot connection.
- D. Inspect the connections and look for bubbles.
- E. If no bubbles appear, the connection is safe.
- F. If bubbles appear, there is a leak. Close the propane tank valve and loosen and re-tighten this connection.
- G. Check for leaks again.
- H. If bubbles still appear, close the propane tank valve and call the gas supplier. DO NOT attempt to use the heater.

OPERATION

WARNING: DO NOT attempt to operate heater until you have read and understand all precautions. Failure to do so can result in serious personal injury, death or property damage.

Before Turning Gas Supply ON.

Your heater was designed and approved for **OUTDOOR USE ONLY**. DO NOT use it inside a building or any other enclosed area.

Make sure surrounding areas are free of combustible materials such as gasoline and other flammable vapors or liquids.

Ensure that there is no obstruction to air ventilation.

Be sure all gas connections are tight and there are no leaks.

Be sure the access panel is clear of debris.

Be sure any component removed during assembly or servicing is replaced and fastened prior to starting.

Before Lighting

Heater should be thoroughly inspected before each use. Have a qualified service person inspect the heater at least annually. If relighting a hot heater, always wait at least 5 minutes.

LIGHTING INSTRUCTIONS

TO TURN ON THE HEATER:

1. Turn the control knob "OFF".
2. Open gas valve fully.
3. Press and turn the control knob to "HI" position (counterclockwise 90°). Press down the control knob and hold 3-5 seconds. While holding down the control knob, press the igniter button several times until the pilot flame ignites. Hold the knob about 30 seconds and then release.

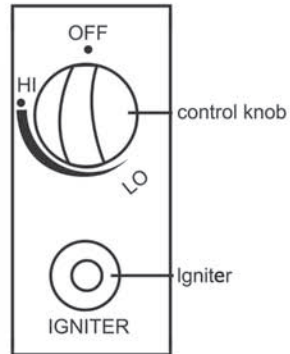

Note: If the pilot flame does not light or it goes out, repeat Step 3 above.

NOTE:

- If a new tank has just been connected, please allow at least one minute or more for the air in the gas pipeline to purge out through the pilot hole, or simply do Step 3.
- When lighting the pilot flame make sure that the variable control knob is continuously depressed while pressing the igniter button. Variable control knob can be released after the pilot flame has been lit for 20~20 seconds.
- Pilot flame can be watched and checked from the peephole located on the base of burner.
- If the pilot flame does not light or it goes out, repeat Step 3.

If the burner flame goes out accidentally or it is blown out by wind, turn off the heater and wait at least 5 minutes or more to let the gas dissipate before relighting to avoid possible gas explosion
Repeat steps 2 to 4.

TO TURN OFF THE HEATER.

1. Press and turn the control knob to "OFF" position.
2. Turn off the valve on the gas cylinder and disconnect the cylinder.

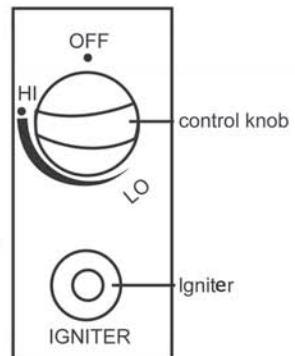

WARNING

FOR YOUR SAFETY

If at any time you are unable to light burner and smell gas, wait 5 minutes to allow gas to dissipate before attempting to light heater. If after 1 minute, you are unable to light burner, wait 5 minutes and allow flammable vapors to dissipate before attempting to light heater again.

CAUTION: Avoid inhaling fumes emitted from the heater's first use. Smoke and odor from the burning of oils used in manufacturing will appear. Both smoke and odor will dissipate after approximately 30 minutes. The heater should not produce thick black smoke.

Note:

The burner may be noisy when initially turned on. To eliminate excessive noise from the burner, turn the control knob to the "LO" position, then turn the knob to the level of heat desired.

Warning : White smoke may appear around the radiant head during the first minutes of the initial firing.

When heater is ON:

Emitter screen will become bright red due to intense heat. The color is more visible at night. Burner will display tongues of blue flame. These flames should not be yellow or produce thick black smoke, indicating an obstruction of airflow through the burners. If the flame is very small, this indicates the supply pressure is not enough.

Relighting the heater:

- 1) Turn the control knob to "OFF" position.
- 2) Wait five (5) minutes before attempting to relight pilot.
- 3) Repeat steps beginning with step 2 on page 12.

Before leaving the heater unattended:

- 1) Turn the control knob to "OFF" position and turn LP cylinder to "OFF" position.
- 2) Never leave the patio heater unattended while in use.

Shut down instructions

- 1) Push in and turn control knob clockwise to "OFF" position.
- 2) Turn LP tank gas valve clockwise to "OFF" position when heater is not in use.

NOTE: After use, some discoloration of the emitter screen is normal.

If you suspect gas leakage:

- 1) Turn the control knob to "OFF" position.
- 2) Turn LP cylinder to "OFF" position.
- 3) Wait 5 minutes to allow gas to dissipate.
- 4) If odor continues, immediately call your gas supplier.

Warning: Heater will be hot after use.
Handle with extreme care.

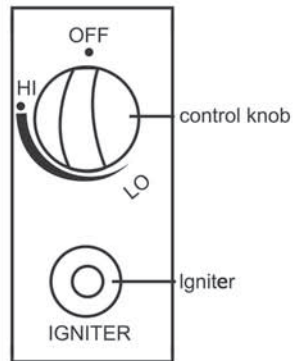
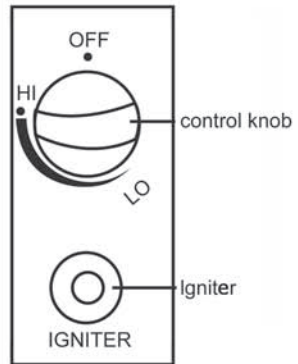

LOCATION OF HEATER WHILE IN USE

CAUTION: WHEN CERTAIN MATERIALS OR ITEMS ARE LEFT UNDER THIS HEATER WHILE IN USE, THEY WILL BE SUBJECT TO RADIANT HEAT AND COULD BE SERIOUSLY DAMAGED.

This heater is to be used for the heating of outdoor patios, decks, spas, pool, and open working areas. This heater is for outdoor use ONLY.

Always make sure that adequate fresh air ventilation is provided and follow the spacing tolerances shown in the picture below. The minimum clearances must be maintained at all times.

This heater must be placed on level, firm ground.

Never operate in an explosive atmosphere. Keep away from areas where gasoline or other flammable liquids or vapors are stored or used.

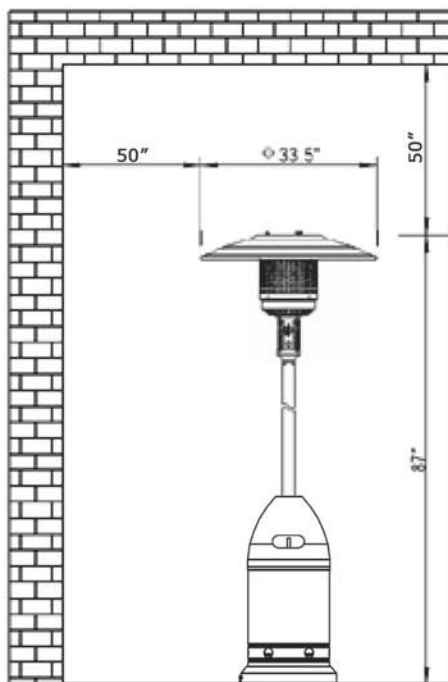

CLEANING AND MAINTENANCE

To enjoy years of outstanding performance from your heater, make sure you perform the following maintenance on a regular basis:

Keep exterior surfaces clean.

1. Use warm soapy water for cleaning. Never use flammable or corrosive cleaning agents
2. While washing your heater, be sure to keep the area around the burner and pilot assembly dry at all times. If the gas control is exposed to water in any way, DO NOT try to use it. It must be replaced.

Keep the heater area free and clean from combustible materials, gasoline or other flammable vapors and liquids. Visually check burner flames.

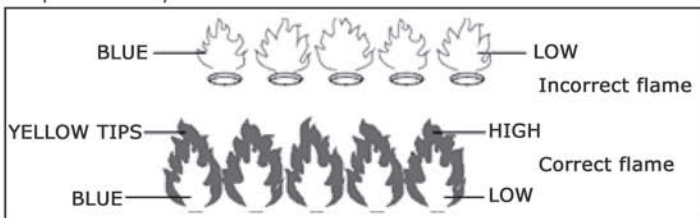

Visually check the hose assembly inside the post and check for any cracks or worn sections.

1. Unscrew gas hose and regulator hose with 3/4" inch open end wrench and adjustable wrench.
2. Screw down the screws on pole, and take out the burner head assembly.
3. Check if there are any cracks or worn sections on hose. If yes, contact your gas supplier to replace the hose.
4. At least once a year, the unit should be inspected for the presence of spiders, spider webs or other insects.

Air flow must be unobstructed. Keep controls, burner and circulating air passageways clean. Signs of possible blockage include:

1. Gas odor with extreme yellow tipping of flame.
2. Heater does not reach the desired temperature.
3. Heater glow is excessively uneven.
4. Heater makes uneven popping noise.

Spiders and insects can nest in burner or orifices. This dangerous condition can damage heater and render it unsafe for use. Clean burner holes by using a heavy-duty pipe cleaner. Compressed air may help clear away smaller particles.

Carbon deposits may create a fire hazard. Clean dome and engine with warm soapy water if any carbon deposits develop.

NOTE:

In a salt-air environment (such as near an ocean), corrosion occurs more quickly than normal. If the heater is exposed to this type of environment, you should frequently check for corroded areas and repair them promptly.

TROUBLESHOOTING

Problem	Problem cause	solution
Burner will not light	Pressure is low	Fuel tank is near empty
	Control valve not ON	Turn valve to ON
	Thermocouple bad	Replace thermocouple
	Pilot light assembly bent or not in correct location	Place pilot in proper position and retry
Burner flame is low	Supply hose is bent or twisted	Straighten hose and perform leak test on hose
	Blockage in burner injector	Clean or replace burner injector
Burner flame goes off immediately after ignition	Low gas pressure	Let the pilot flame stay lit for 10 minutes before setting variable knob to "LO"
Emitter glows unevenly	Blockage in burner injector	Clean or replace burner injector
	Base is not on level surface	Place heater in level surface
	Low gas pressure	Replace cylinder with a new cylinder
Thick black smoke	Blockage in burner	Turn off the heater and let it cool. Remove blockage and clear burner inside and outside.
Carbon build-up	Dirt or film on reflector and flame screen	Clean reflector and flame screen

Manufacturer: Changzhou Wellife Furnace Co., Ltd.
 Add: Xinqiao Village, Zouqu Town, Wujin District, Changzhou City,
 Jiangsu Province, China
 Tel: 86-519-83310111
 Fax: 86-519-83311577
www.globalwellife.com

Distributed By:
Well Traveled Living
716 S 8th Street
Amelia Island, FL 32034
Toll Free: 866-WTL-SUPP



Web: www.wtliving.com
Email: cservice@welltraveled.net

1 YEAR LIMITED WARRANTY – Customers in the Continental US

All components are warranted for a period of 1 year after date of purchase by the original owner against defects in materials and workmanship under normal use. This warranty does NOT cover normal wear and weathering, assembly and/or maintenance OR use in a commercial application. At Well Traveled Living's sole discretion, products under warranty will be repaired and/or replaced at no charge to the customer. Any returns sent back to Well Traveled Living must be sent via prepaid freight and in the original retail packaging.

For warranty service contact Well Traveled Living at the address, phone numbers or internet site and email listed in this owner's manual. Be sure to have your sales receipt, date of purchase and catalogue/model numbers available when calling. All warranty service will be coordinated by the Well Traveled Living's, Amelia Island, Florida service center.

This warranty is extended only to the original purchaser. Proof of purchase will be required before warranty service is rendered. The sales receipt is the only valid proof of purchase. This warranty only covers failures due to defects in materials or workmanship which occur during normal use. Failures and/or damage which result from accident, negligence, misuse, abuse, neglect, mishandling, alteration or modification, failure to maintain, improper assembly or maintenance, service by unauthorized agency or use of unauthorized components or damage that is attributable to acts of God are NOT covered.

*****THERE ARE NO EXPRESS WARRANTIES EXCEPT AS LISTED ABOVE*****

*****PURCHASER ASSUMES ALL RISKS IN THE ASSEMBLY AND OPERATION OF THIS UNIT*****

*****FAILURE TO FOLLOW WARNINGS AND OPERATIONAL INSTRUCTIONS CONTAINED IN THIS MANUAL CAN RESULT IN SEVERE PROPERTY DAMAGE AND/OR PERSONAL INJURY*****

IN NO EVENT WILL WELL TRAVELED LIVING, OR ITS DIRECTORS, OFFICERS OR AGENTS BE LIABLE TO THE PURCHASER OR ANY THIRD PARTY, WHETHER IN CONTRACT, IN TORT, OR ON ANY OTHER BASIS, FOR ANY INDIRECT, SPECIAL, PUNITIVE, EXEMPLARY, CONSEQUENTIAL, OR INCIDENTAL LOSS, COST, OR DAMAGE ARISING OUT OF OR IN CONNECTION WITH THE SALE, MAINTENANCE, USE, OR INABILITY TO USE THE PRODUCT, EVEN IF WELL TRAVELED LIVING OR ITS DIRECTORS, OFFICERS OR AGENTS HAVE BEEN ADVISED OF THE POSSIBILITY OF SUCH LOSSES, COSTS OR DAMAGES, OR IF SUCH LOSSES, COSTS, OR DAMAGES ARE FORESEEABLE. IN NO EVENT WILL WELL TRAVELED LIVING, OR ITS OFFICERS, DIRECTORS, OR AGENTS BE LIABLE FOR ANY DIRECT LOSSES, COSTS OR DAMAGES THAT EXCEED THE PURCHASE PRICE OF THE PRODUCT.

SOME JURISDICTIONS DO NOT ALLOW THE EXCLUSION OR LIMITATION OF INCIDENTAL OR CONSEQUENTIAL DAMAGES, SO THE ABOVE LIMITATION OR EXCLUSION MAY NOT APPLY TO THE PURCHASER.

This limited warranty gives you specific legal rights and you may also have other rights which vary from jurisdiction to jurisdiction. The provisions of the United Nations Convention on Contracts for the Sales of Goods shall not apply to this limited warranty or the sale of products covered by this limited warranty.

*****IMPORTANT NOTICE*****

-Do **NOT** return to place of purchase-
For customer service and warranty issues
contact our Customer Service Center at:
(866)-985-7877 OR
Email: cservice@welltraveled.net

Customer Service Hours: Mon. – Fri. 9:00 a.m. – 6:00 p.m. (EST)