

Family: Hathaway | Item No. 3220 AN/OB

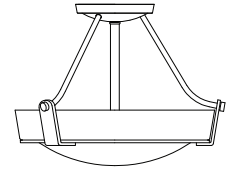

**Drawing 1 - Fixture Assembly**

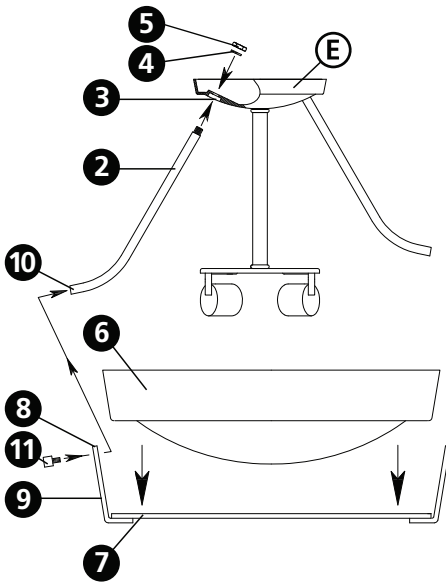

**Drawing 2 - Strap Detail**

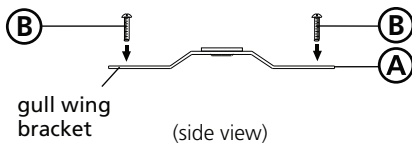

**Drawing 3 - Fixture Mounting**

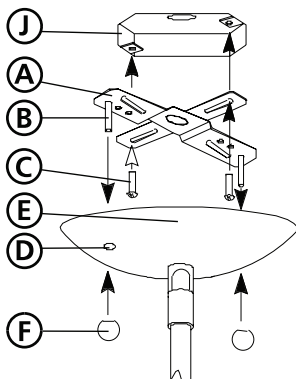

## ▼ start here

**1**

1. Find a clear area in which you can work.
2. Unpack fixture and glass from carton.
3. Carefully review instructions prior to assembly.

**\*\*\* The construction of this fixture will be accomplished by first assembling main body of the fixture, mounting the mounting strap to the junction box, making all necessary electrical connections, hanging the fixture from the ceiling, and then installing the glass.**

**2**

1. Slip threaded end of upright (2) into recessed hole (3) of canopy (E) - see **Drawing 1**.
2. Slip lockwasher (4) onto threaded end of upright (2). Then thread on hex nut (5) - do not tighten at this time.
3. Repeat steps 1 and 2 for remaining uprights.

**3**

1. Prepare gem strap (A) for mounting by threading two screws (B) provided into back of gull wing bracket of gem strap (A) - see **Drawing 2**.
  - Be sure the holes into which the screws are threaded match the spacing of holes (D) in the canopy (E) - see **Drawings 2 and 3**.
3. Mount gem strap (A) to junction box (J), using the two 1" screws (C) provided.

**SAFETY WARNING: READ WIRING AND GROUNDING INSTRUCTIONS (I.S. 18) AND ANY ADDITIONAL DIRECTIONS. TURN POWER SUPPLY OFF DURING INSTALLATION. IF NEW WIRING IS REQUIRED, CONSULT A QUALIFIED ELECTRICIAN OR LOCAL AUTHORITIES FOR CODE REQUIREMENTS.**

**4**

Make electrical connections from supply wire to fixture lead wires. Refer to instruction sheet (I.S. 18) and follow all instructions to make all necessary wiring connections.

**5**

1. Hang the fixture by slipping the holes (D) in the canopy (E) over the screws (B) in the mounting strap (A) - see **Drawing 3**.
2. Thread on ball knobs (F) to secure fixture to the ceiling.

1. To install glass, set glass (6) onto ring (7) - see **Drawing 1**.
2. Line up hole (8) in ring upright (9) with hole (10) in end of upright (2).
3. Slip threaded stud (11) through hole (8) in ring upright (9) and thread into hole (10) of upright (2) - do not tighten at this time.
4. Repeat steps 2 and 3 for the remaining uprights.
5. Tighten all hex nut and ball knob stud connections at this time.
6. Fixture can now be lamped accordingly.

Note: Maximum wattage for 3220 fixture is 100 watts per bulb.

4.8.10