







Features:

- European Minimalist Design
- Cast brass valve
- Ceramic disc valve cartridge
- Adjustable hot limit safety stop
- Pressure Balance cartridge maintains constant output temperature in response to changes in relative hot and cold supply pressures
- Multi-functional showerhead
- Concealed mounting hardware

Showerhead Maximum Flow Rate: 2.5 GPM (9.5L/min)

Kit Options	Product Number	
Glance Pressure Balance Shower Set	831/451	
Glance Pressure Balance Valve for Shower Set	831/131	

Available Finishes:	
Polished Chrome	100
Platinum Nickel	150

Rough & Trim Options	Product Number	
Trim Only- -Includes Pressure Balance Valve & Shower Head	831/486	
Trim Only- -Pressure Balance Valve Only	831/546	
Shower Head Only	861/082	
Rough Only	899/260/191	

ROUGH-IN DIAGRAM SHOWN ON REVERSE SIDE

IMPORTANT: These Measurements are subject to change or cancellation. No responsibility is assumed for use of superseded or voided pages.

CODES & STANDARDS

These products meet and exceed the following codes and standards:

ASME A112.18.1

CSA B125

ASSE 1016

 Meets the American Disabilities Act Guidelines and **ANSI A117.1** Requirements for the physically challenged.

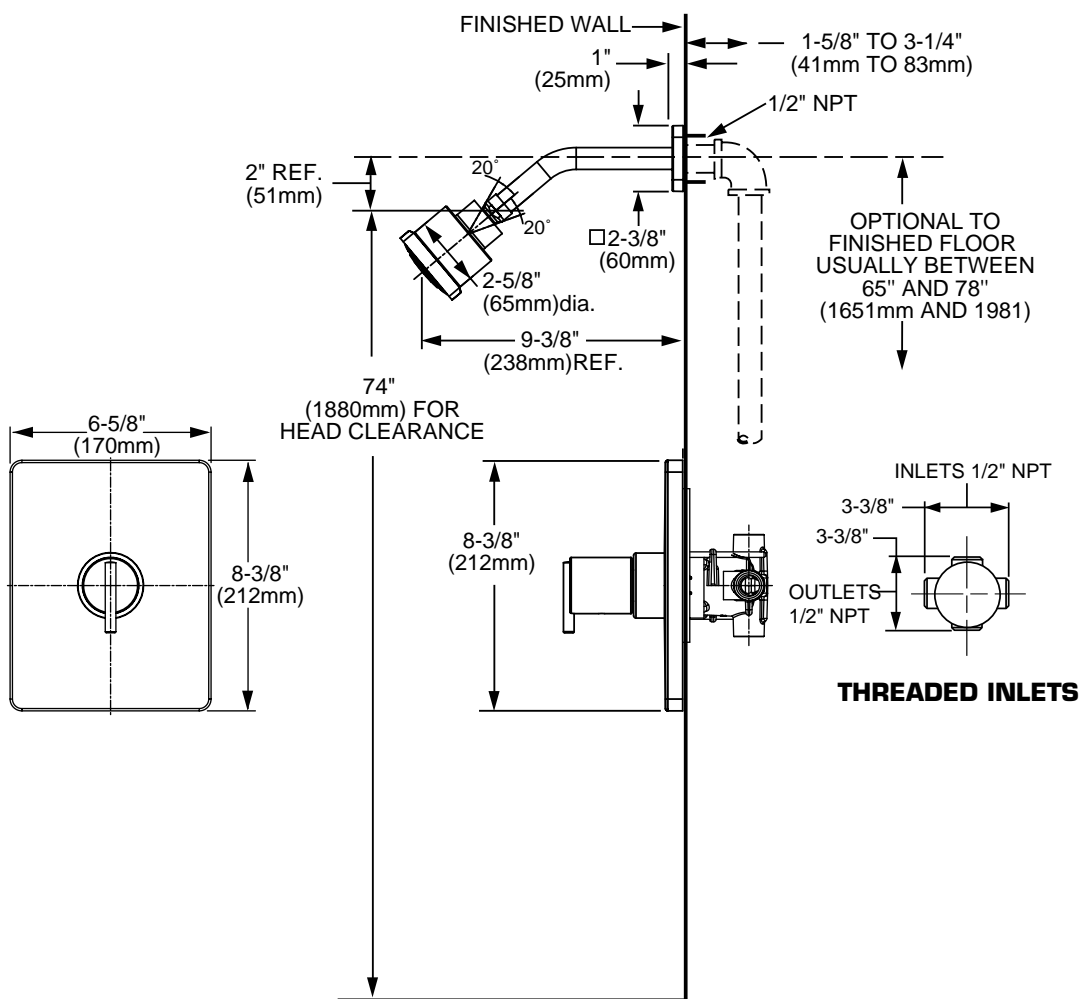
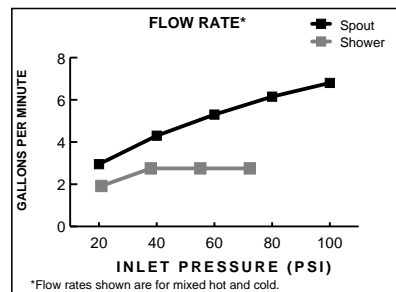

IMPORTANT: These Measurements are subject to change or cancellation. No responsibility is assumed for use of superseded or voided pages.