

Features

- Solid polypropylene plastic.
- Elongated closed-front seat.
- Contoured seat for user comfort.
- Quick-Release™ hinge caps snap open and seat pulls forward for removal.
- Quick-Attach™ stainless steel fastener allows for top-mount screwdriver only install.



Codes/Standards



















IAPMO/ANSI Z124.5

KOHLER® One-Year Limited Warranty

See website for detailed warranty information.

Available Color/Finishes

Color tiles intended for reference only.

Color	Code	Description
	0	White
	W2	Earthen White
	96	Biscuit
	47	Almond
	NY	Dune
	55	Innocent Blush™
	Y2	Sunlight
	NG	Tea Green
	95	Ice™ Grey
	G9	Sandbar
	33	Mexican Sand™
	6	Skylight
	45	Wild Rose™
	K4	Cashmere
	58	Thunder™ Grey
	52	Navy
	7	Black Black™
	12	Jersey Cream
	17	Teal
	53	Raspberry Puree

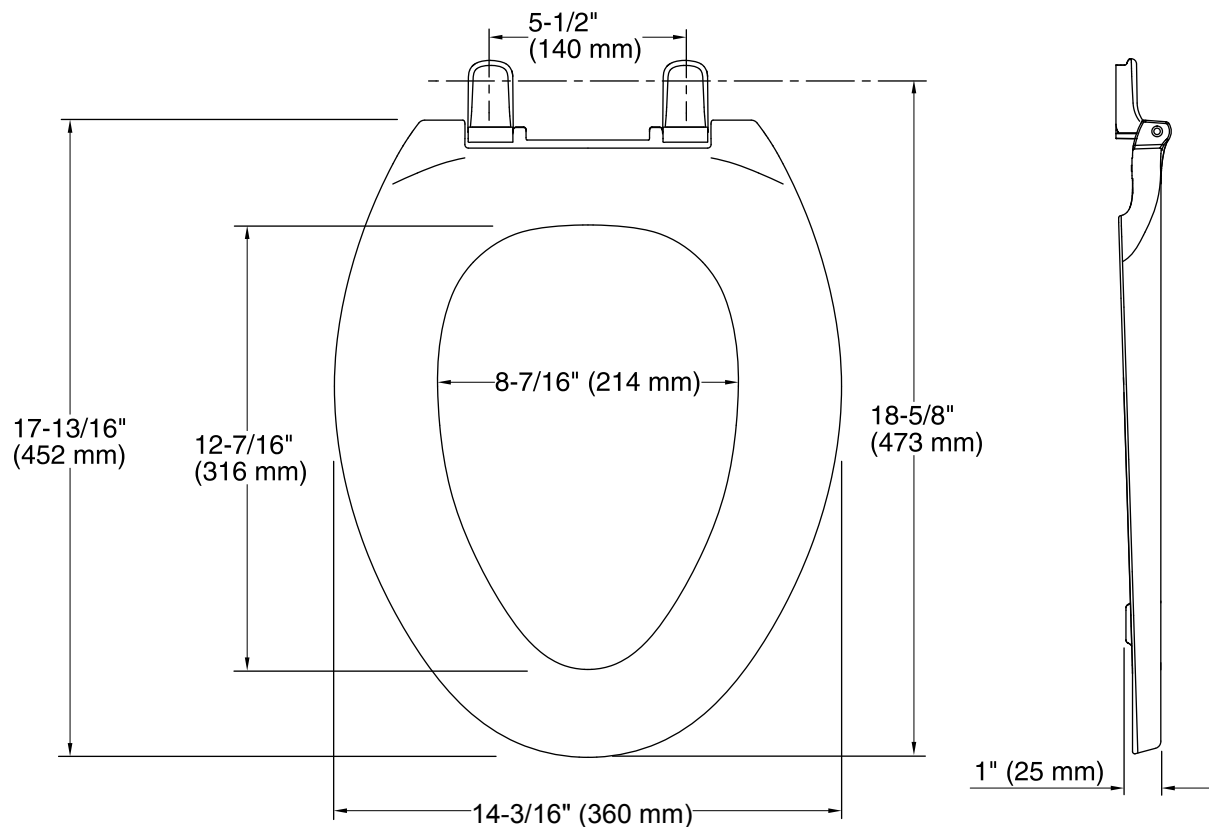

Technical Information

All product dimensions are nominal.

Seat shape type: Elongated

Seat front type: Closed front

Seat hinge type: Quick-Attach®, Quick-Release™

Seat-mounting holes: 5-1/2" (140 mm)

Notes

Install this product according to the installation guide.