

INSTALLER: LEAVE THIS MANUAL WITH THE APPLIANCE
CONSUMER: RETAIN THIS MANUAL FOR FUTURE REFERENCE



INSTALLATION AND OPERATION INSTRUCTIONS

CERTIFIED UNDER CANADIAN AND AMERICAN NATIONAL STANDARDS: CSA C22.2 No-46 / UL 1278 CSA STANDARD

EF39HD ELECTRIC FIREPLACE

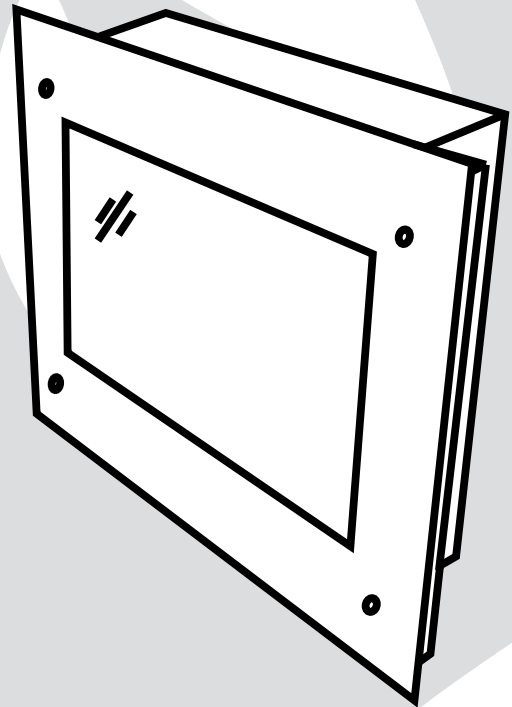

CERTIFIED FOR CANADA AND UNITED STATES USING ANSI/CSA METHODS.

SAFETY INFORMATION

! WARNING

If the information in these instructions are not followed exactly, an electrical shock or fire may result causing property damage, personal injury or loss of life.

- Do not store or use gasoline or other flammable vapors and liquids in the vicinity of this or any other appliance.



Wolf Steel Ltd., 24 Napoleon Rd., Barrie, ON L4M 4Y8 Canada • (705)721-1212 • fax(705)722-6031
www.napoleonfireplaces.com • ask@napoleon.on.ca
For customer service inquiries, please call 1-866-592-6667
(9:00am - 5:00pm PST)

TABLE OF CONTENTS

1.0	INTRODUCTION	2
1.1	WARRANTY	3
1.2	DIMENSIONS	4
1.3	LISTING APPROVALS	4
1.4	GENERAL INSTRUCTIONS	5
2.0	LOCATING APPLIANCE	7
2.1	UNPACKING AND TESTING APPLIANCE	7
2.2	GROUNDING APPLIANCE	7
3.0	INSTALLATION	8
3.1	MINIMUM CLEARANCE TO COMBUSTIBLES	8
3.2	INSTALLING THE APPLIANCE	8
3.4	GLASS EMBER INSTALLATION	9
3.5	GLASS FRONT INSTALLATION	10
4.0	FINISHING	10
4.1	MINIMUM MANTEL CLEARANCES	10
5.0	OPERATING INSTRUCTIONS	11
5.1	MAIN POWER SWITCH	11
5.2	OPERATING BY REMOTE CONTROL	11
6.0	MAINTENANCE	12
6.1	REPLACING THE FLAME GENERATION LIGHT BULBS	13
6.2	REPLACING THE EMBER BED LIGHT BULBS	14
7.0	REPLACEMENT PARTS	15
8.0	TROUBLESHOOTING	16
9.0	SERVICE HISTORY	16

1.0 INTRODUCTION

WARNING

- Do not operate heater before reading and understanding operating instructions. Failure to operate heater according to operating instructions could cause fire or injury.
- Risk of burns. The heater should be turned off and cooled before servicing.
- Do not install damaged, incomplete or substitute components.
- Do not burn wood or other materials in this fireplace.
- Adults and especially children should be alerted to the hazards of high surface temperatures and should stay away to avoid burns or clothing ignition. Supervise young children when they are in the same room as the fireplace.
- Clothing or other flammable material should not be placed on or near the fireplace.
- Due to high temperatures, the fireplace should be located out of traffic and away from furniture and draperies.
- Ensure you have incorporated adequate safety measure to protect infants/toddlers from touching hot surfaces.
- Even after the fireplace is out, the glass and/or screen will remain hot for an extended period of time.
- Check with your local hearth specialty dealer for safety screens and hearth guards to protect children from hot surfaces. These screens and guards must be fastened to the floor.
- Any safety screen or guard removed for servicing must be replaced prior to operating the fireplace.
- It is imperative that the control compartments, circulating blower and its passageway in the fireplace and are kept clean. The fireplace should be inspected before use and at least annually by a qualified service person. More frequent cleaning may be required due to excessive lint from carpeting, bedding material, etc. The fireplace area must be kept clear and free from combustible materials, gasoline and other flammable vapors and liquids.
- Under no circumstances should this fireplace be modified.
- This fireplace must not be connected to a chimney flue pipe serving a separate solid fuel burning appliance.
- Do not use this fireplace if any part has been under water. Immediately call a qualified service technician to inspect the fireplace and to replace any part of the control system which has been under water.
- Do not operate the fireplace with the glass door removed, cracked or broken. Replacement of the glass should be done by a licensed or qualified service person.
- Do not strike or slam shut the fireplace glass door.
- Keep the packaging material out of reach of children and dispose of the material in a safe manner. As with all plastic bags, these are not toys and should be kept away from children and infants.

NOTE: Changes, other than editorial, are denoted by a vertical line in the margin.

1.1 WARRANTY

NAPOLEON® electric fireplaces are manufactured under the strict Standard of the world recognized ISO 9001 : 2000 Quality Assurance Certificate.

NAPOLEON® products are designed with superior components and materials, assembled by trained craftsmen who take great pride in their work. Once assembled the complete fireplace is thoroughly inspected by a qualified technician before packing to ensure that you , the customer, receive the quality product that you expect from NAPOLEON®.

NAPOLEON® ELECTRIC FIREPLACE PRESIDENT'S LIFETIME LIMITED WARRANTY

Electrical components and wearable parts such as fan/heater, motors, switches, nylon bearing components and remote controls are covered and NAPOLEON® will provide replacement parts free of charge during the first year of limited warranty.

Light bulbs and fuses are NOT covered by the warranty.

Any labour related to warranty repair is not covered.

CONDITIONS AND LIMITATIONS

NAPOLEON® warrants its products against manufacturing defects to the original purchaser only -- i.e., the individual or legal entity (registered customer) whose name appears on the warranty registration card filed with NAPOLEON® -- provided that the purchase was made through an authorized NAPOLEON® dealer and is subject to the following conditions and limitations:

This factory warranty is non-transferable and may not be extended whatsoever by any of our representatives.

Installation must be done in accordance with the installation instructions included with the product and all local and national building and fire codes.

This limited warranty does not cover damages caused by misuse, lack of maintenance, accident, alterations, abuse or neglect and parts installed from other manufacturers will nullify this warranty.

This limited warranty further does not cover any scratches, dents, corrosion or discoloring caused by excessive heat, abrasive and chemical cleaners nor chipping on porcelain enamel parts, mechanical breakage of PHAZER™ logs.

In the first year only, this warranty extends to the repair or replacement of warranted parts which are defective in material or workmanship provided that the product has been operated in accordance with the operation instructions and under normal conditions.

NAPOLEON® will not be responsible for installation, labour or any other expenses related to the reinstallation of a warranted part and such expenses are not covered by this warranty.

Notwithstanding any provisions contained in the President's Limited Lifetime Warranty, NAPOLEON's responsibility under this warranty is defined as above and it shall not in any event extend to any incidental, consequential or indirect damages.

This warranty defines the obligations and liability of NAPOLEON® with respect to the NAPOLEON® electric fireplace and any other warranties expressed or implied with respect to this product, its components or accessories are excluded.

NAPOLEON® neither assumes, nor authorizes any third party to assume, on its behalf, any other liabilities with respect to the sale of this product.

Any damages to fireplace, brass trim or other component due to water, weather damage, long periods of dampness, condensation, damaging chemicals or cleaners will not be the responsibility of NAPOLEON®.

The bill of sale or copy will be required together with a serial number and a model number when making any warranty claims from your authorized dealer. The warranty registration card must be returned within fourteen days to register the warranty.

NAPOLEON® reserves the right to have its representative inspect any product or part thereof prior to honouring any warranty claim.

ALL SPECIFICATIONS AND DESIGNS ARE SUBJECT TO CHANGE WITHOUT PRIOR NOTICE DUE TO ON-GOING PRODUCT IMPROVEMENTS. NAPOLEON® IS A REGISTERED TRADEMARK OF WOLF STEEL LTD. PATENTS U.S. 5.303.693.801 - CAN. 2.073.411, 2.082.915. © WOLF STEEL LTD.

1.2 DIMENSIONS

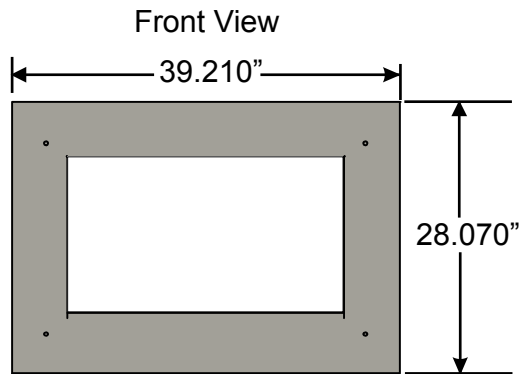

FIGURE 1.2.1

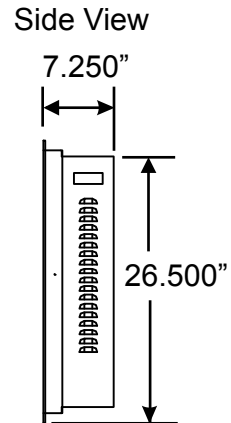

FIGURE 1.2.2

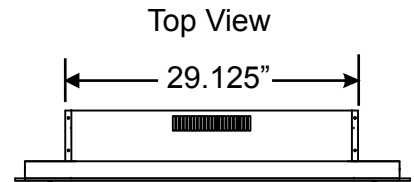

FIGURE 1.2.3

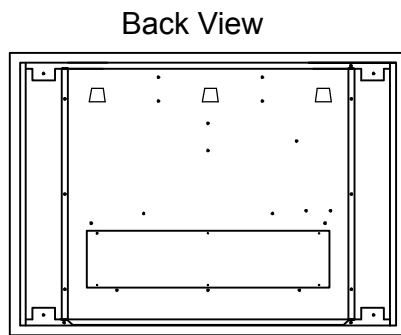

FIGURE 1.2.4

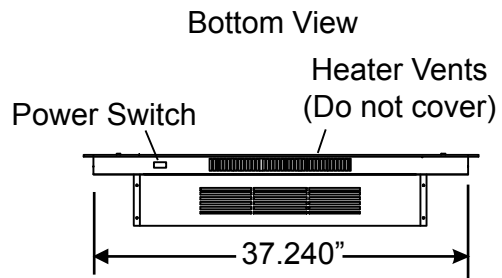

FIGURE 1.2.5

1.3 LISTING APPROVALS

This appliance has been tested in accordance with the CSA Standards for fixed and location-dedicated electric room appliances in the United States and Canada. If you need assistance during installation, please contact your local dealer.

NOTE: This appliance must be electrically wired and grounded in accordance with local codes or, in the absence of local codes, with National Electric Code ANSI/NFPA 70-latest edition or the Canadian Electric Code, CSA C22.1 as appropriate.

Model Number	EF39HD
Description	Wall-Mount Appliance
Voltage	120V AC
Watts	MAX 1500W
Amps	15 AMP Grounded Circuit
Appliance Width	39.21"
Appliance Height	28.07"
Appliance Depth	7.250"
Net Weight	66.08 lbs
Gross Weight	81.50 lbs

1.4 GENERAL INSTRUCTIONS

 WARNING
Read these instructions completely before beginning installation. Failure to follow them could cause a appliance malfunction resulting in serious injury and/or property damage.
All electric appliances have hot and arcing or sparking parts inside. Do not use it in areas where gasoline, paint or flammable liquids are present.
This electric appliance is tested and listed for use only with the optional accessories listed in these instructions. Use of optional accessories not specifically tested for this electric appliance could void the appliance warranty and/or result in a safety hazard.
Risk of electric shock.
Do not open.
No user-serviceable parts inside.
Do not use damaged electrical cords.
Servicing should be done only while the appliance is disconnected from the power supply circuit.
High temperature, risk of fire. Keep electrical cords, drapery, furnishings, and other combustibles at least 36" from the front of the appliance and away from sides and rear.

This electric appliance meets the construction and safety standards of H.U.D. for application in manufactured homes when installed according to these instructions.

1. Prior to plugging your appliance into an electrical outlet, verify that the house circuit breakers for the outlet are on.
2. The appliance may emit a slight, harmless odour when first used. This odour is normal and it is caused by the initial heating of internal appliance elements and will not occur again.
3. If your appliance does not emit heat, consult the operation section of this manual for further information.
4. Use with a CSA or UL certified surge protector.

When using electric appliances, basic precautions should always be followed to reduce the risk of fire, electric shock, and injury to persons, including the following:

1. Read all instructions before using this appliance.
2. This appliance is hot when in use. To avoid burns, do not let bare skin touch hot surfaces. If provided, use handles when moving this appliance. Keep combustible materials, such as furniture, pillows, bedding, papers, clothes, and curtains at least 36" from the front of the appliance and keep them away from the sides and rear.
3. Extreme caution is necessary when this appliance is used by or near children and whenever the appliance is left operating and unattended.
4. Always unplug appliance when not in use.
5. Do not operate this appliance with a damaged cord or plug after the appliance malfunctions, has been dropped or damaged in any manner. Return appliance to authorized service facility for examination, electrical or mechanical adjustment, or repair.
6. Do not use outdoors.
7. This appliance is not intended for use in bathrooms, laundry areas and similar indoor locations. Never locate appliance where it may fall into a bathtub or other water container.
8. Do not run cord under carpeting. Do not cover cord with throw rugs, runners, or the like. Arrange cord away from traffic area and where it will not be tripped over.
9. To disconnect appliance, turn controls to off, then remove plug from outlet.
10. Connect to properly grounded outlets only.
11. Do not insert or allow foreign objects to enter any ventilation or exhaust opening as this may cause an electric shock or fire, or damage the appliance.
12. To prevent a possible fire, do not block air intakes or exhaust in any manner. Do not use on soft surfaces, like a carpet, where openings may become blocked.
13. Use this appliance only as described in this manual. Any other use not recommended by the manufacturer may cause fire, electric shock, or injury to persons.
14. Avoid the use of an extension cord because the extension cord may overheat and cause a risk of fire. However, if an extension cord must be used, the cord shall be No.14 AWG minimum size and rated not less than 1875 watts.

SAVE THESE INSTRUCTIONS.

2.0 LOCATING APPLIANCE

! WARNING

Due to high temperatures, this electric appliance should be located out of traffic. Keep combustible materials such as furniture, pillows, bedding, papers, clothes and curtains at least 36" from the front of the appliance.

Never locate this electric appliance where it may fall into a bathtub or other water container.

Wear safety gloves and safety glasses for protection during installation and maintenance.

To prevent contact with sagging or loose insulation, the electric appliance must not be installed against vapor barrier or exposed insulation. Localized overheating could occur and a fire could result.

Do not expose the electric appliance to the elements (such as rain, etc.)

2.1 UNPACKING AND TESTING APPLIANCE

Carefully remove the appliance from the box. Prior to installing the appliance, test to make sure the appliance operates properly by plugging the power supply cord into a conveniently located 120 Volt grounded outlet.

2.2 GROUNDING APPLIANCE

This appliance is for use on 120 Volts. The cord has a plug as shown in (A) of Figure 1 given below. An adapter as shown in (C) is available for connecting three-blade grounding type plugs to two-slot receptacles. The green grounding lug extending from the adapter must be connected to a permanent ground such as a properly grounded outlet box. The adapter should not be used if a three-slot grounded receptacle is available.

To disconnect appliance, turn controls to off, then remove plug from outlet.

GROUNDING METHODS

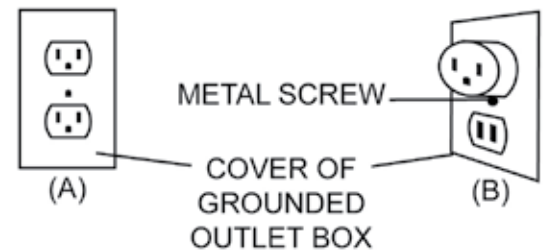

FIGURE 2.2



GROUNDING PIN



NOT ALLOWED IN CANADA

3.0 INSTALLATION

! WARNING

RISK OF FIRE! The power cord must not be pinched against a sharp edge. Secure cord to avoid tripping or snagging to reduce the risk of fire, electric shock or personal injury. Do not run cord under carpeting. Do not cover cord with throw rugs, runners or the like. Arrange cord away from traffic areas and where it will not be tripped over.

RISK OF FIRE! To prevent a possible fire, do not block air intake or exhaust in any manner. Do not use on soft surfaces where openings may become blocked.

RISK OF FIRE! Do not blow or place insulation against the appliance.

This electric appliance is tested and listed for use only with the approved optional accessories. Use of optional accessories not specifically tested for this electric appliance could void the warranty and/or result in a safety hazard.

If the information in these instructions is not followed exactly, a fire or explosion may result causing property damage, personal injury or death. Do not store or use gasoline or other flammable vapors in the vicinity of this or any other appliance.

This appliance is heavy. It is highly recommended that two people install this appliance.

Heater vents on the electric appliance cannot, in any way, be covered as it may create a fire hazard.

3.1 MINIMUM CLEARANCE TO COMBUSTIBLES

Measurements are taken from the glass front.

Bottom	19 3/4"	Top	2 1/2" to mantel
Sides	4"	Top	4 1/2" to ceiling
Back	0"		

3.2 INSTALLING THE APPLIANCE

Due to the many different materials used on different walls, it is highly recommended that you consult your local builder before you install this appliance on the wall.

1. Select a location that is not prone to moisture and is located at least 36" away from combustible materials such as curtain drapes, furniture, bedding, paper, etc.
2. Have two people hold the appliance against the wall to determine the final location.
3. With the appliance in position and level measure from the floor to the top back edge as illustrated.
4. The supplied wall mount bracket will be centered on the back of the appliance. This bracket has four slots and three hooks on it. The top slots will be located 1.250" down from the previously measured top back edge. The bottom slots will be 2.250" down from this edge.

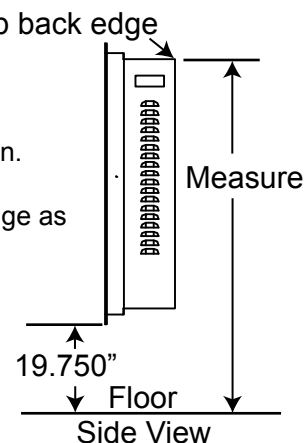

5. Mark out location, then mount the bracket onto the wall using the four supplied screws. Ensure the top slots measurement from the floor is 1.250" lower than the top back edge measured earlier. This bracket MUST have the hooks facing upward and be level.

NOTE: It is strongly recommended that the mounting bracket be screwed into the wall studs where possible. If the wall studs cannot be used, ensure that the supplied plastic anchors are used to affix the bracket to the wall and the bracket is adequately secured.

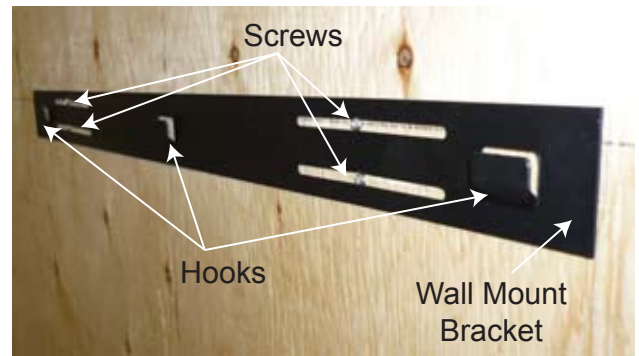

6. With the wall mounting bracket installed have two people lift the appliance up and insert the three hooks on the bracket into the three slots on the back of the appliance.
7. Check the appliance for stability ensuring that the bracket will not pull free from the wall, causing the appliance to fall.

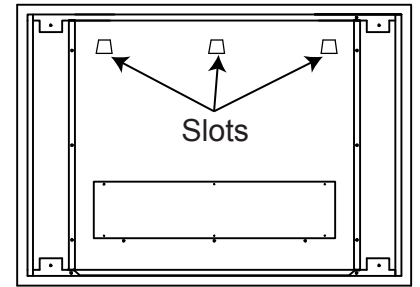

Back View

3.4 GLASS EMBER INSTALLATION

Glass front must be removed and the appliance must be mounted in its final location before the glass embers are installed.

Glass embers may have sharp edges, wear safety glasses and gloves when handling.

1. Carefully place glass embers into the bottom tray on the front of the appliance as illustrated.
2. Apply an even layer of glass embers. Clean up any fallen pieces and install glass front.



3.5 GLASS FRONT INSTALLATION

! WARNING

Do not over tighten the bolts. Over tightening the bolts may result in glass breakage.

It is recommended that two people install this glass front onto the appliance. Wear safety glasses and gloves when handling glass.

1. Hold up the glass front onto the appliance (logo side out).
2. Line up the four holes in the glass with the four threaded holes in the appliance.
3. Use the four supplied bolts with the supplied washers. Insert the bolts through the glass front and into the threaded holes, and finger tighten as illustrated.

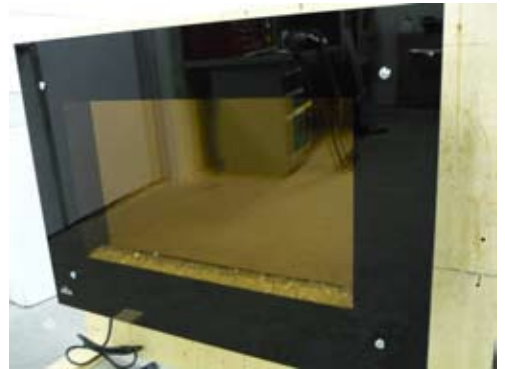

4.0 FINISHING

! WARNING

Power supply service must be completed prior to finishing to avoid reconstruction.

Heater vents and air openings cannot be covered in any circumstances.

4.1 MINIMUM MANTEL CLEARANCES

! WARNING

When using paint or lacquer to finish the mantel, the paint or lacquer must be heat resistant to prevent discolouration.

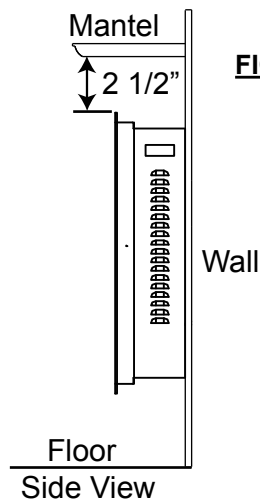

5.0 OPERATING INSTRUCTIONS

Once the appliance has been plugged in to a grounded electrical outlet, it is ready to operate.

NOTE: Ensure the house circuit breakers for the power supply are turned on.

5.1 MAIN POWER SWITCH

The Main Power Switch is located on the bottom of the appliance as illustrated. The "I" indicates ON and "O" indicates OFF. Push the switch to "I" to turn on the appliance and the flame effect.

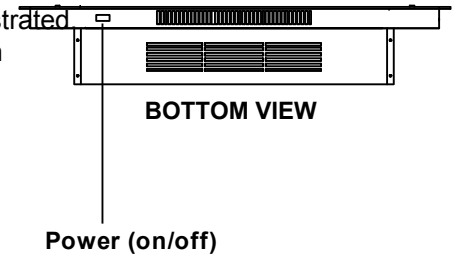











FIGURE 5.1

5.2 OPERATING BY REMOTE CONTROL

NOTE: Make certain the batteries are installed correctly and are new.

1. Plug in your electric appliance.
2. Make certain the appliance's Main Power  Switch is at the ON position! The remote control will NOT work if the Main Power Switch is at the OFF position.
3. When operating the remote control, it must be directed towards the front of the appliance.
4. The  button at the top left of the remote is the main  power button. Pressing this button activates the power to the appliance.
5. To activate the heater, press the  button. Press and release the  button to cycle through LO, MED, HI and OFF. The heater has a built-in thermostat so it will shut off automatically once the pre-set temperature is reached. It will also turn on automatically if the room temperature drops below the pre-set temperature.
6. To adjust the flame height and ember bed brightness, press the " +" or " -" buttons. To increase the flame height and ember bed brightness, press the " +" button, to decrease the flame height and ember bed brightness, press the " -" button. There are seven levels of flame effects.
7. To turn off the appliance, press the button  once.

NOTE: This remote control must remain within 8 meters or 26 feet of the appliance to be effective.

FIGURE 5.2

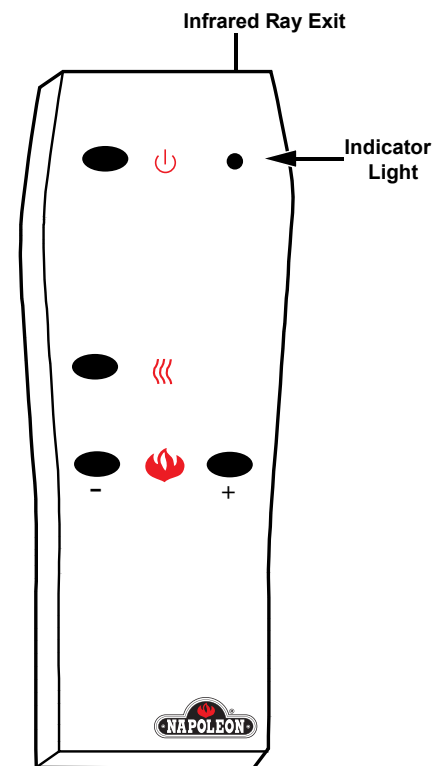

6.0 MAINTENANCE

! WARNING

PREPARATION FOR MAINTENANCE

Always disconnect the power and allow the electric appliance to cool before performing any cleaning, maintenance or relocation of this electric appliance. Turn controls to OFF and remove plug from outlet or turn off the house circuit breaker to electric appliance receptacle.

Do not install replacement bulbs that exceed specified maximum watts.

The halogen light bulbs in your appliance can become extremely hot. Allow at least 10 minutes between turning off the appliance and removing the light bulbs to avoid accidental burns.

Do not handle the lamp (bulbs) with bare fingers, oils from your skin will damage the bulbs when they heat up. Use gloves or a clean dry cloth when handling bulbs.

Turn off electric appliance or the house circuit breaker to the appliance before performing any cleaning and/or maintenance. Allow electric appliance to cool completely.

Most halogen light bulbs are rated to last approximately 1800 hours. Like all light bulbs, halogen bulbs require periodic replacement. When the bulbs in your appliance have burned out you will notice one or more of following:

COMMON OBSERVED PROBLEMS:

- There is no flame
- Flame or Ember bed is dim or dark in certain areas
- Flame is not moving or glowing

Your appliance must be opened in order to replace the light bulbs. To reduce the number of times you need to open the appliance, replace all bulbs at the same time if they are close to the end of their rated life.

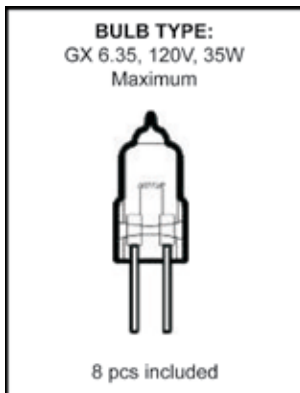

There are a total of 12 halogen light bulbs (Type GX6.35, rated 120Volts, 35Watts) in your appliance:

- 2 bulbs provide illumination for the ember bed
- 4 bulbs provide illumination for flame generation
- 6 extra bulbs for replacement

FIGURE 6.0

6.1 REPLACING THE FLAME GENERATION LIGHT BULBS

! WARNING

Remove the fireplace from the wall and turn off electrical power before servicing the appliance.

1. Remove the 6 screws on the back plate of the appliance near the bottom. Open back plate from the top.
2. Locate the flame generation cylinder drum. It is attached to the inside of the back plate. They are 2 matte black sheet metal pieces with holes in them, either of which can be removed from the appliance.
3. Remove the screw as illustrated, that is used to secure the flame generation cylinder drum.
4. Squeeze half of drum cylinder until its top edge clears the top drum track. Remove the bottom edge of the cylinder drum from the bottom drum track. This will give you access to the light bulbs.
NOTE: Do not exert excessive pressures on the drum cylinder as this may cause damage.
5. Remove spring clip. Hold socket and pull out old bulb.
6. Hold socket and push in new bulb (DO NOT exceed wattage). Reattach spring clip.
7. Repeat steps 5 and 6 for the remaining bulbs if necessary.
8. Replace the back plate by reattaching the 6 screws that were removed from step 1.

Flame Generation Bulb Location

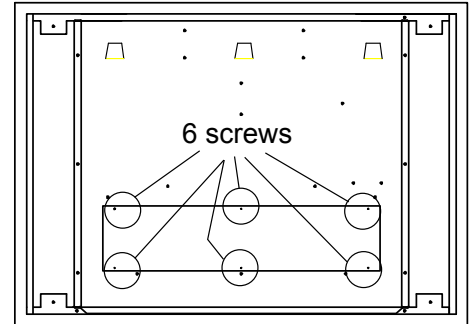

Back View

FIGURE 6.1.1

Flame Generation Bulb Location

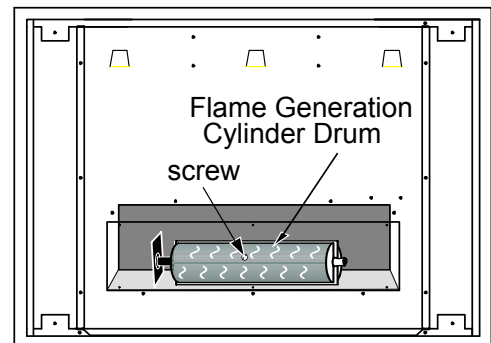

Back View

FIGURE 6.1.2

Drum Bulb Replacement

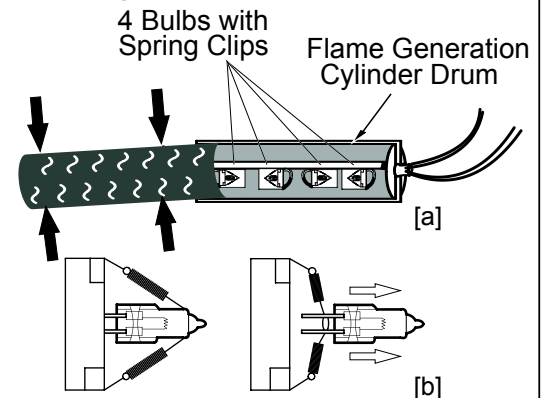
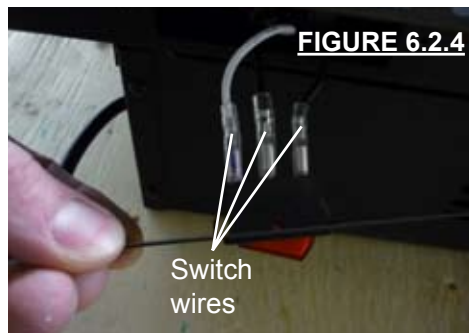
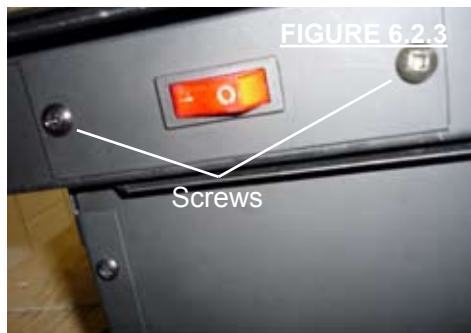
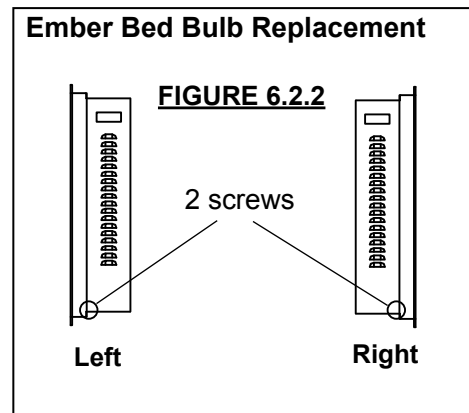
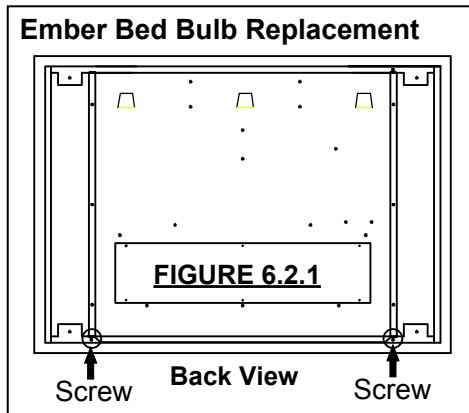
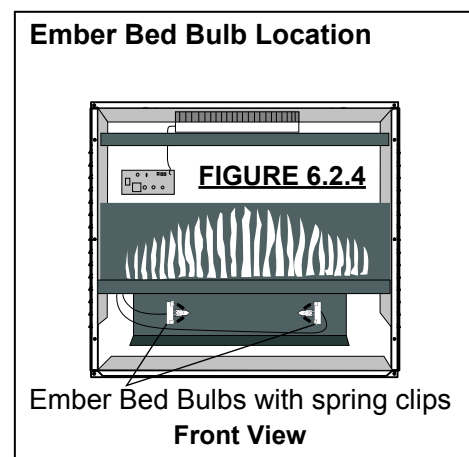
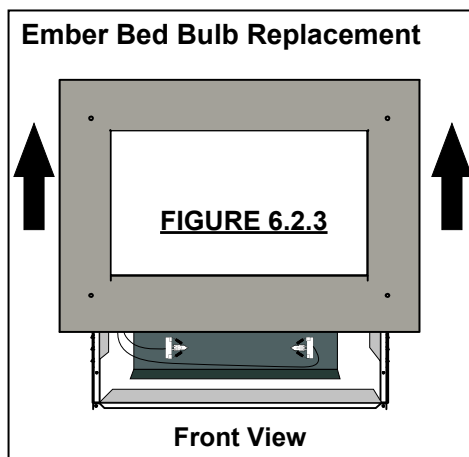

FIGURE 6.1.3

6.2 REPLACING THE EMBER BED LIGHT BULBS



1. Remove the 2 screws on the bottom left and right corner of the appliance behind the front panel.
2. Remove the 2 screws holding the main power switch and pull switch down carefully. Before removing the wires we recommend labelling the 3 wires on the switch.



3. Lift up and remove the front panel of the appliance.
4. Locate the 2 ember bed bulbs as shown.
5. Remove spring clip. Hold socket and pull out old bulb.
6. Hold socket and push in new bulb (DO NOT exceed wattage). Reattach spring clip.
7. Repeat steps 4 and 5 for the remaining bulb if necessary.
8. Replace the front panel and the screws.
9. Re-install the 3 wires onto the main power supply switch ensuring the wires are in the correct location.
10. Re-install the switch with the 2 screws that were removed.

7.0 REPLACEMENT PARTS

Contact your dealer or the factory for questions concerning prices and policies on replacement parts. Normally all parts can be ordered through your Authorized dealer / distributor.

FOR WARRANTY REPLACEMENT PARTS, A PHOTOCOPY OF THE ORIGINAL INVOICE WILL BE REQUIRED TO HONOUR THE CLAIM.

When ordering replacement parts always give the following information:

- Model & Serial Number of appliance
- Installation date of appliance
- Part number
- Description of part
- Finish

*** IDENTIFIES ITEMS WHICH ARE NOT ILLUSTRATED. FOR FURTHER INFORMATION, CONTACT YOUR AUTHORIZED DEALER.**

For aftermarket sales and service please call 1-866-592-6667

! WARNING

Failure to position the parts in accordance with this manual or failure to use only parts specifically approved with this appliance may result in property damage or personal injury.

COMPONENTS

REF NO.	EF39HD	DESCRIPTION
1	R-21	REMOTE CONTROL TRANSMITTER
2*	DQ002-011	REMOTE RECEIVER
3	JQ-FAGET1-19	HEATER
4	DQ017-002	BULB
5	SW	SWITCH
6	DQ002-006	CIRCUIT BOARD
7*	GBL74-001-05	FRONT GLASS
8*	GBL74-001-02	GLASS TRAY
9*	GBL74-001-01	MIRROR GLASS
10*	YJF	FAN MOTOR
11*	MS 120V/20/24RPM	DRUM MOTOR
12	JQ-FGT-01	DRUM
13*	W300-0117	GLASS EMBERS

NOTE: Care must be taken when removing and disposing of any broken glass or damaged components. Be sure to vacuum up any broken glass from inside the appliance before operation.

