

Installation Support • Soporte de instalación • Support d'installation

Personal Assistance, Product Specs, & "How-to" Questions:

Asistencia personal, especificaciones del producto y preguntas sobre "cómo hacerlo":

Aide personnelle, spécifications du produit et questions « pratico-pratiques » :

1-800-PFAUCET (732-8238)

pfisterfaucets.com/support



WARNING / ADVERTENCIA / AVERTISSEMENT

To reduce the risk of injury or property damage, read all instructions before installing product. Wear safety goggles. Product must be installed in accordance with all state & local plumbing & building codes. Call a professional if you are uncertain about installing this product.

Para disminuir el riesgo de lesiones o daños a la propiedad, lea todas las instrucciones antes de instalar el producto. Utilice gafas de seguridad. El producto deberá instalarse de acuerdo con la normativa de plomería y construcción estatal y local. Llame a un profesional si no está seguro sobre cómo instalar este producto.

Pour réduire le risque de blessures ou de dommages, lire toutes les instructions avant d'installer le produit. Portez des lunettes de sécurité. Il faut installer le produit en respectant tous les codes de construction et de plomberie locaux et d'état. Appelez un professionnel si vous n'êtes pas certain de la façon d'installer ce produit.

Required Tools Herramientas necesarias Outils nécessaires

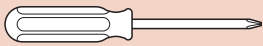

Cross Screwdriver
Destornillador de estrella
Tournevis Phillips

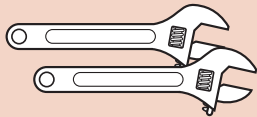

Adjustable Wrenches
Llaves ajustables
Clés à mollette



Plumber's Putty
Masilla para plomería
Masse de plombier



Safety Goggles
Anteojos de seguridad
Lunettes de sûreté

Additional Helpful Tools Otras herramientas útiles Outils supplémentaires utiles

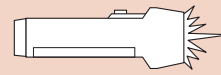

Flashlight
Linterna
Lampe De Poche

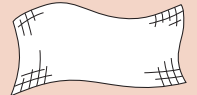

Cloth
Paño de limpieza
Chiffon

Parts in the Box • Piezas en la caja • Pièces dans la boîte

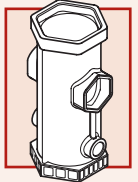
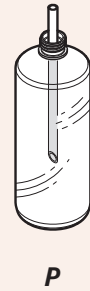
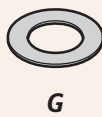
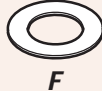
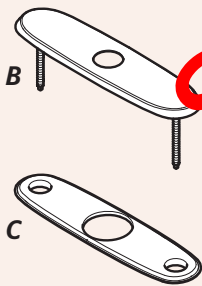
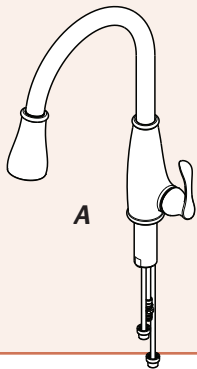

Quick Install™
Tool

1 Turn Off Water Supply • Cierre el suministro de agua • Couper l'alimentation en eau



Locate water supply inlets and shut off the water supply valves. These are usually found under the sink or near the water meter. If you are replacing an existing faucet, remove the old faucet from the sink and clean the sink surface thoroughly.

Ubique las entradas del suministro de agua y cierre las válvulas de suministro de agua. Generalmente se encuentran debajo del fregadero o cerca del medidor de agua. Si se trata de un reemplazo de grifo, quite el grifo viejo y limpie completamente la superficie del fregadero.

Recherchez les entrées d'approvisionnement et fermer les robinets. Ces robinets se trouvent généralement sous l'évier ou près du compteur d'eau. En cas de remplacement d'un robinet existant, retirez le de l'évier et nettoyer soigneusement la surface de ce dernier.

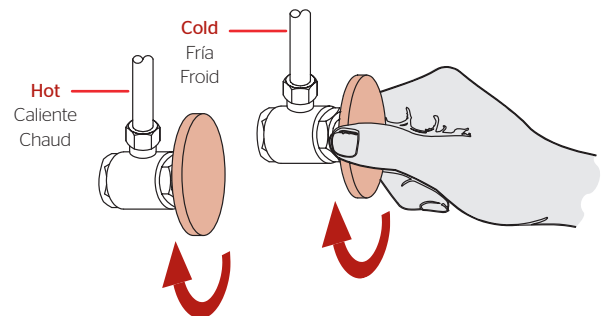

2 **OPTION 1: Install Spout *without Deckplate***
OPCIÓN 1: Instalación de el surtidor sin la placa de cubierta
OPTION 1: Installez le bec sans la plaque de couverture

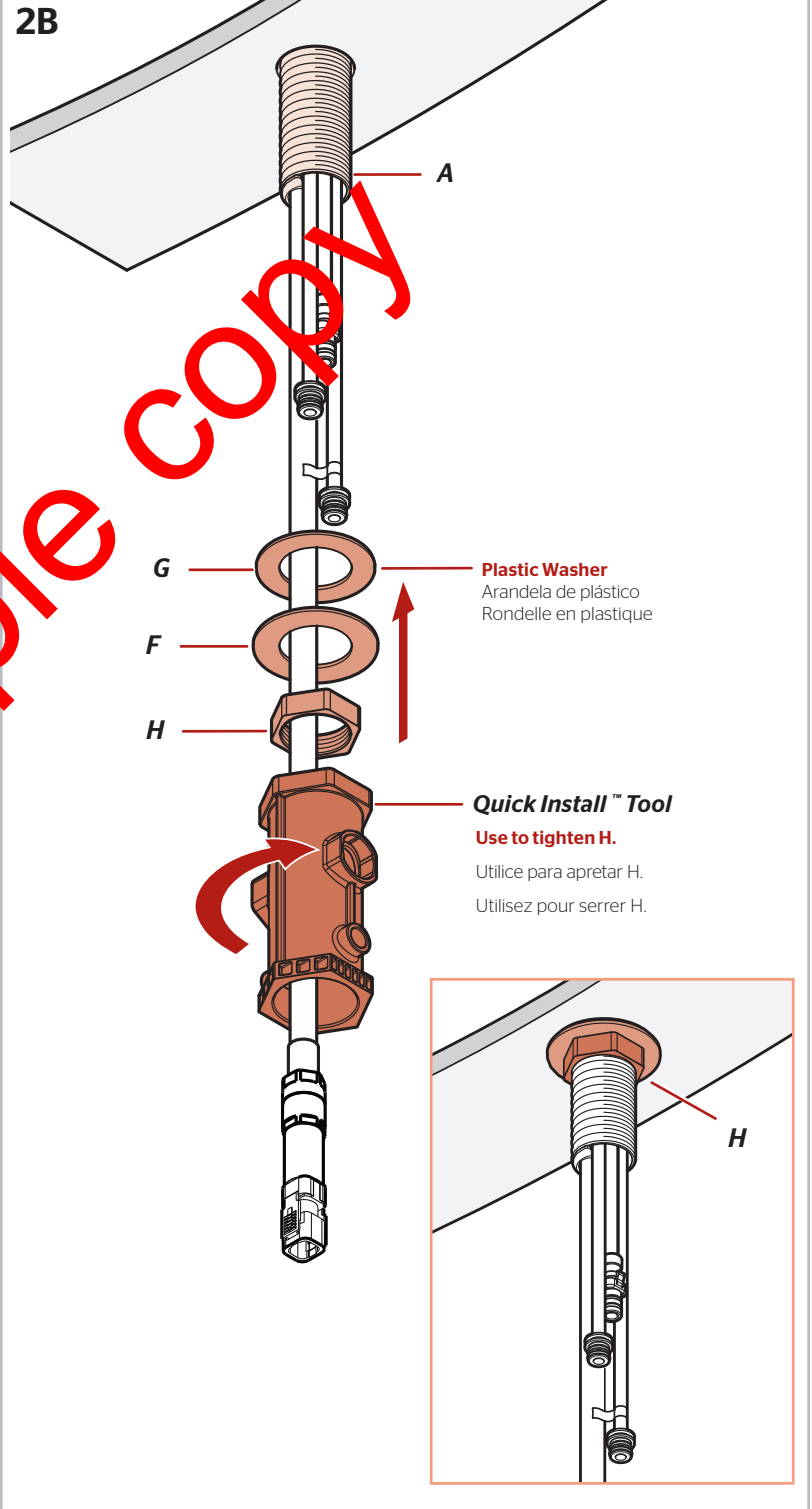
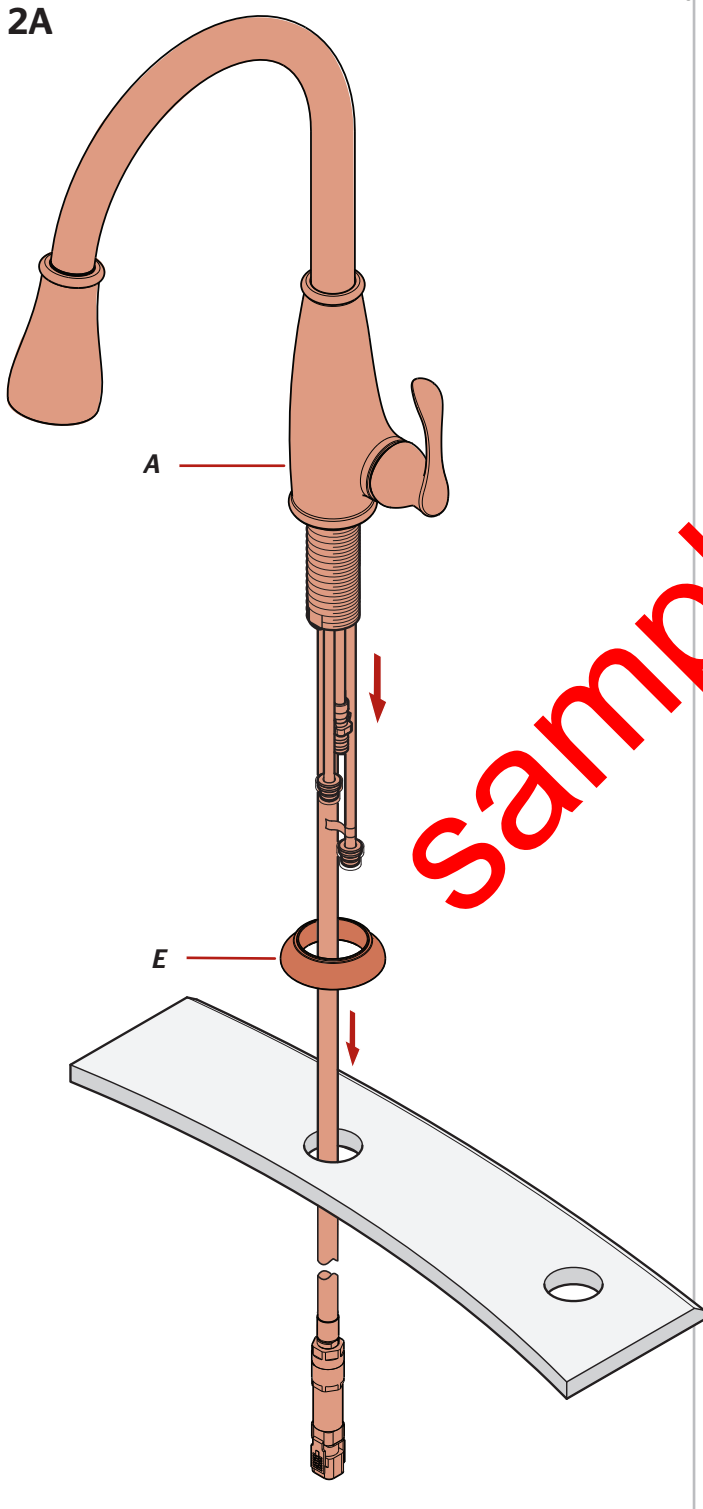
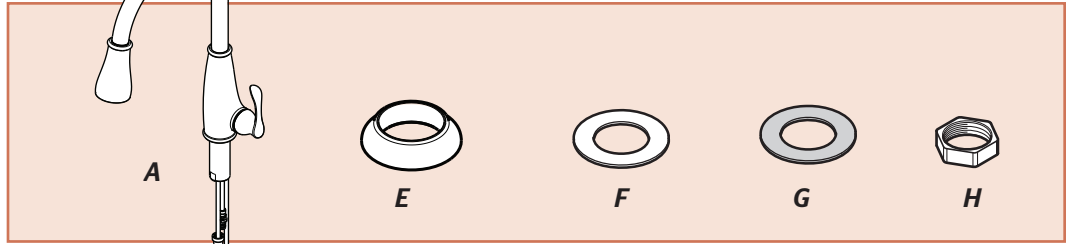
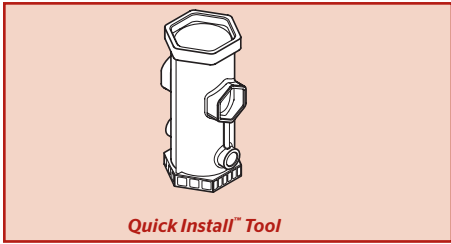
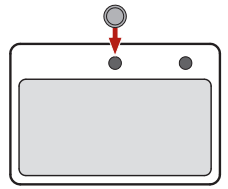
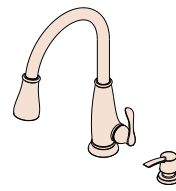

Sample Copy

2 **OPTION 2: Install Spout *with Deckplate***
OPCIÓN 2: Instalación de el surtidor con la placa de cubierta
OPTION 2: Installez le bec avec la plaque de couverture

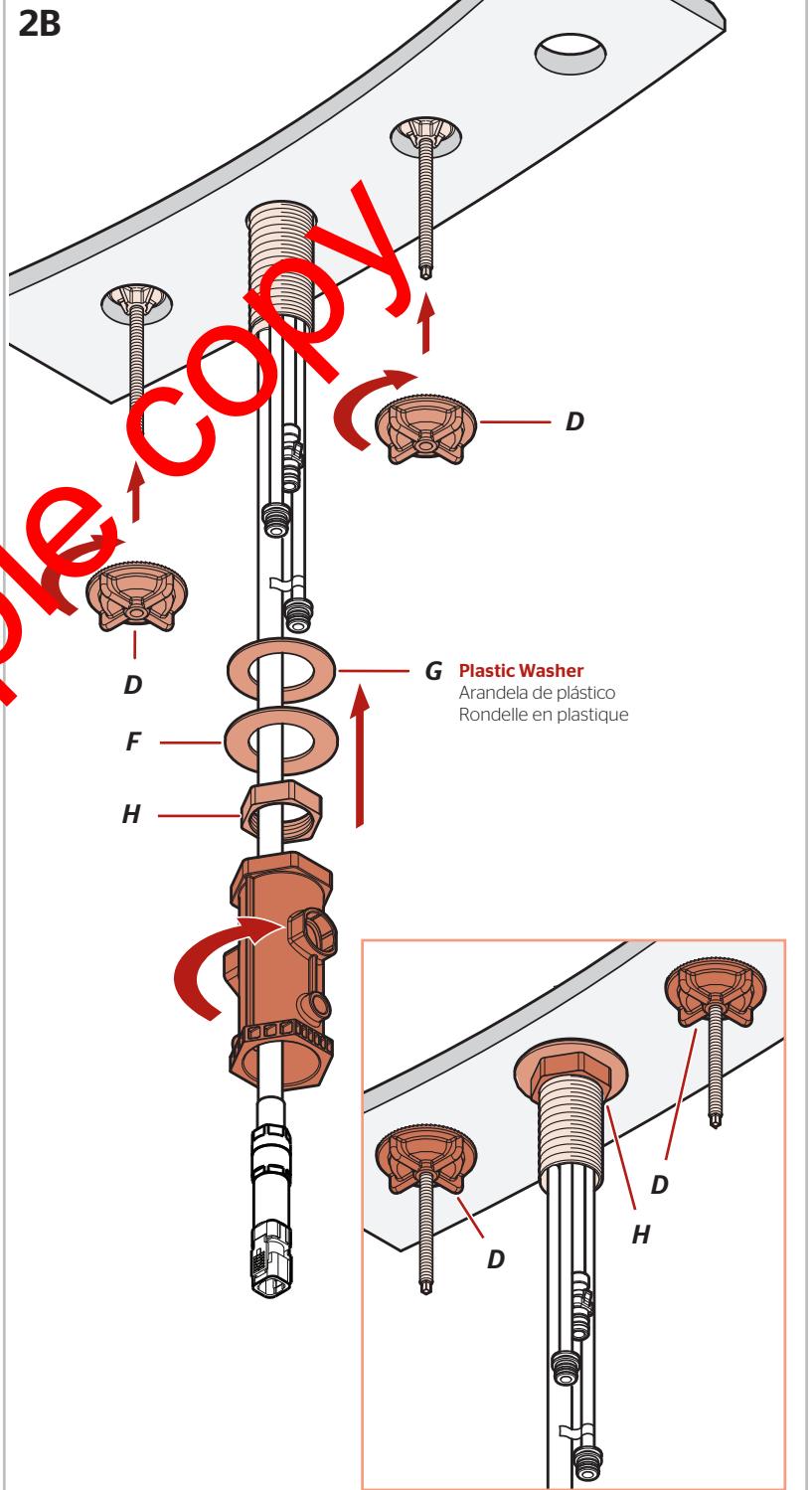
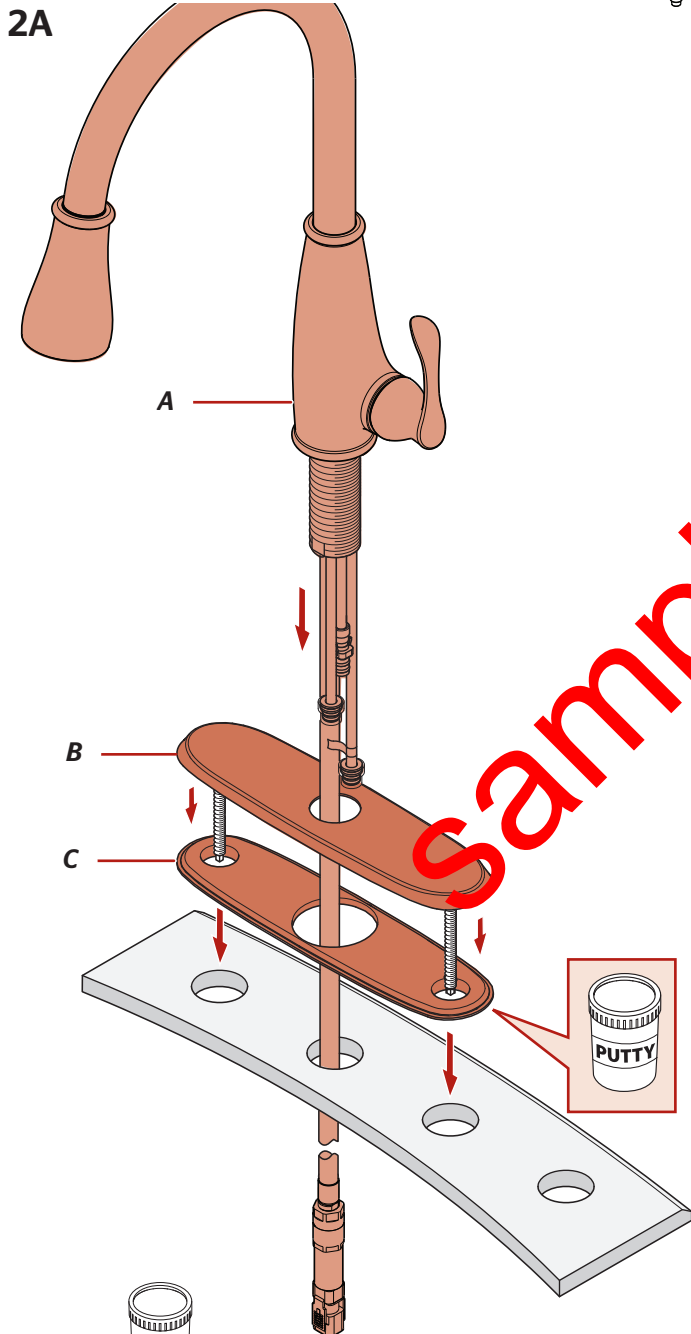
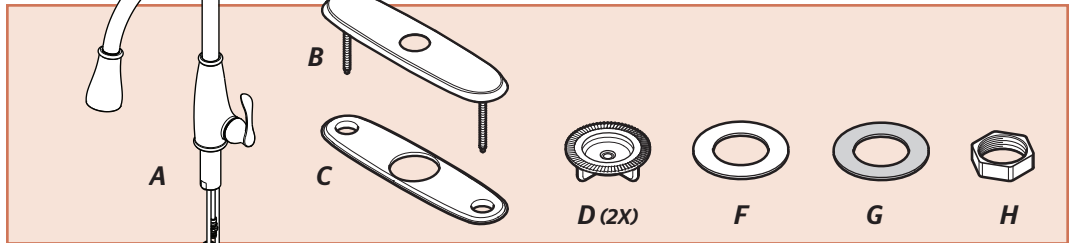
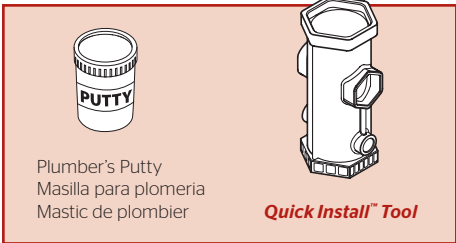
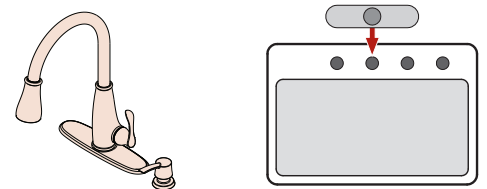

Apply Plumber's Putty in the groove along the bottom outer edge of Plate (C).
 Aplique masilla de plomería en la ranura a lo largo del borde inferior de la placa inferior (C).
 Appliquez du mastic de plombier dans la rainure sur le bord extérieur de la plaque (C).

3 Add Connect Pull-Out Hose & Weight

Conecte la manguera extraíble y añada peso

Connectez le tuyau amovible et ajoutez le poids



Cross Screwdriver
Destornillador de estrella
Tournevis Phillips



J

3A

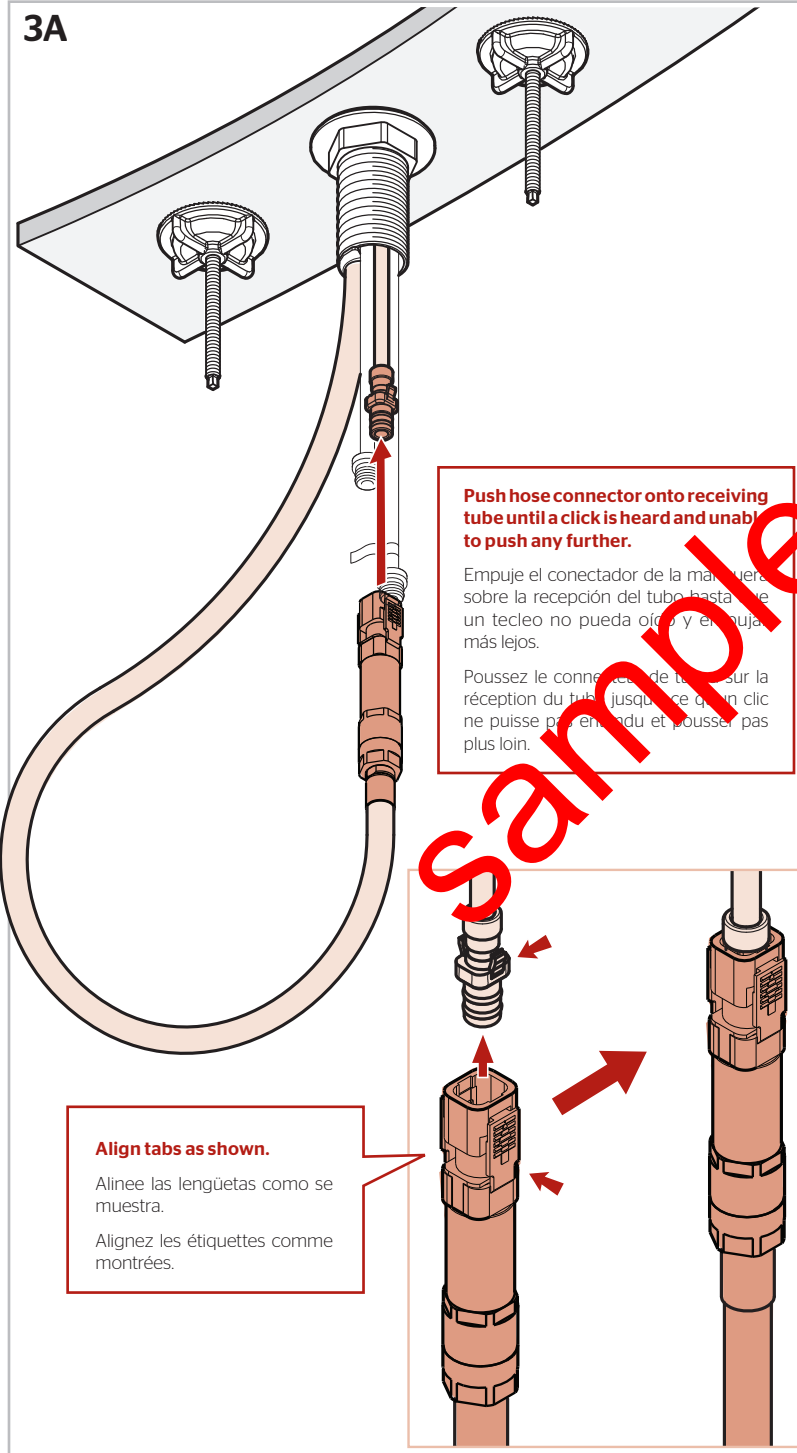

3B

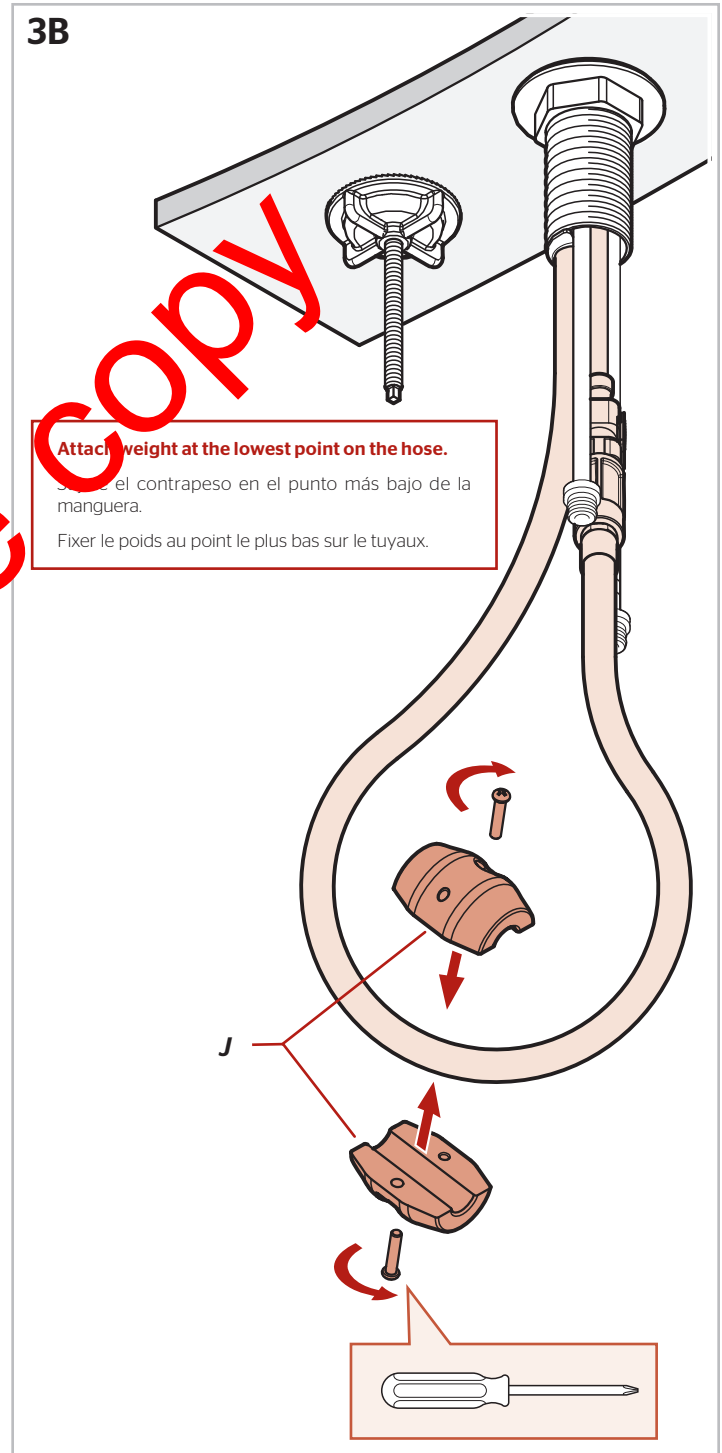

4 Connect Water Supply Lines

Conecte las tuberías de suministro de agua

Raccorder les conduites d'alimentation en eau

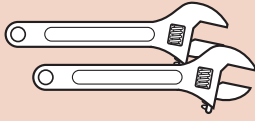

Adjustable Wrenches
Llaves ajustables
Clés à molette



K (2X)



L (2X)

4A

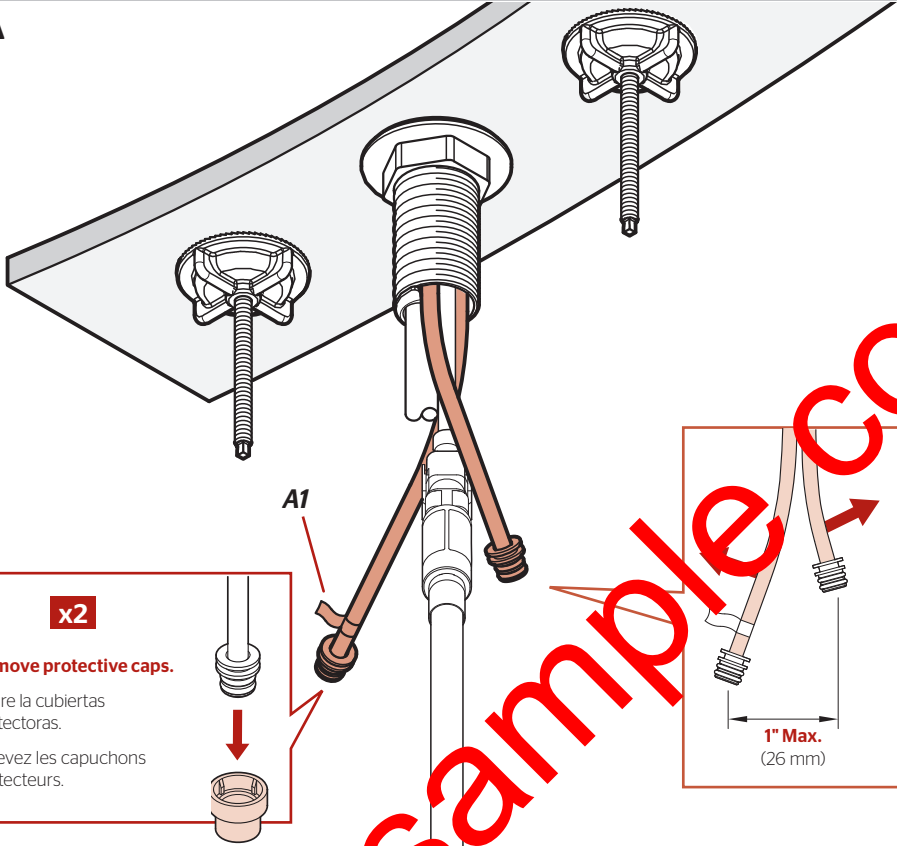

Hot water supply lines connect to left inlet indicated by red tag (A1). Cold water supply lines connect to right inlet.

Water Supply Lines not included. Please consult manufacturer and/or its instructions for the correct method of installation of supply lines and fittings.

NOTE: Incorrect application of supply lines and fittings may result in the failure or leak of the supply lines and fittings.

Las líneas de suministro de agua caliente se conectan en la entrada izquierda indicado con la etiqueta roja (A1). Las líneas de suministro de agua fría se conectan en la entrada derecha.

Las tuberías de suministro de agua no están incluidas. Consulte por favor el fabricante y/o sus instrucciones para el método correcto de instalación de líneas de suministro y de guarniciones.

NOTE: El uso incorrecto de líneas de suministro y de guarniciones puede dar lugar a la falta o al escape de las líneas de suministro y de la guarnición.

La conduite d'eau chaude doit être connectée au robinet de gauche indiqué par l'étiquette rouge (A1). La conduite d'eau froide doit être connectée au robinet de droite.

Les tuyaux d'arrivée d'eau ne sont pas fournis. Veuillez consulter le fabricant et/ou ses instructions pour la méthode correcte d'installation des canalisations et des garnitures d'alimentation.

NOTE : L'application incorrecte des canalisations et des garnitures d'alimentation peut avoir comme conséquence l'échec ou la fuite des canalisations et de l'ajustage de précision d'alimentation.

x2

Remove protective caps.

Retire la cubiertas protectoras.
Enlevez les capuchons protecteurs.

1" Max.
(26 mm)

4B

x2

Hot & Cold
Caliente y fría
Chaud et froid

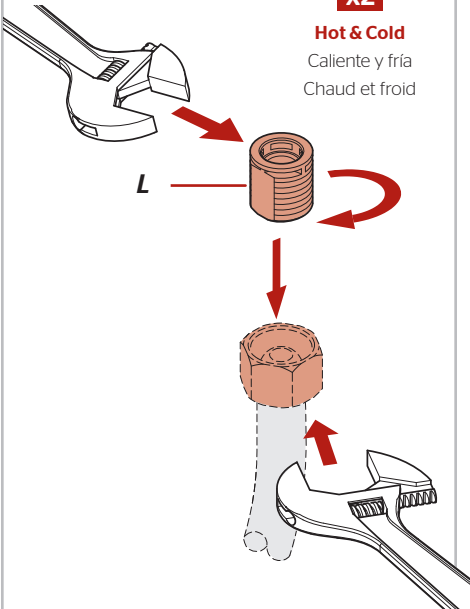

4C

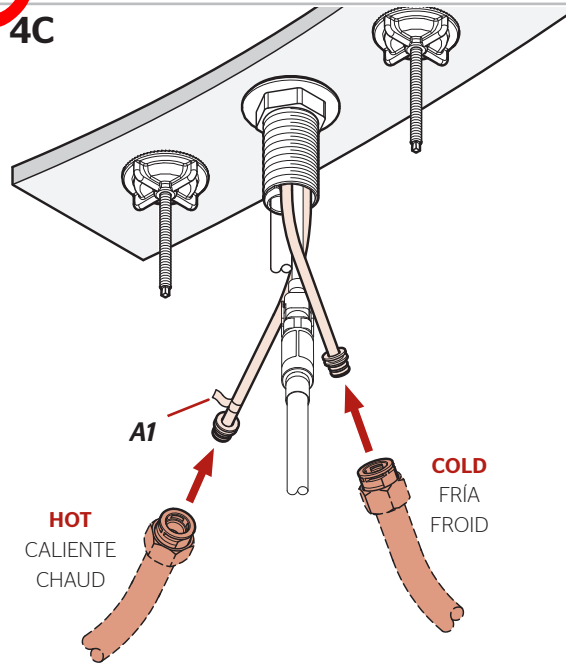

4D

x2

Hot & Cold
Caliente y fría
Chaud et froid

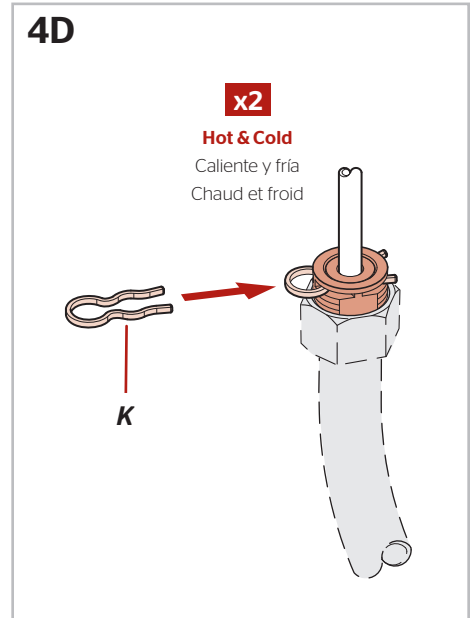

5 Install Soap Dispenser

Instale el dispensador de jabón

Installer le distributeur de savon

No Tools Required for This Step
 No se necesitan herramientas para este paso
 Aucun outil n'est nécessaire pour cette étape

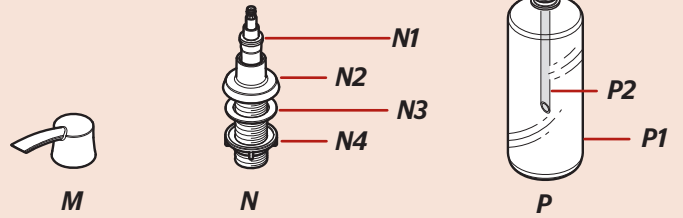

5A Disassemble Desensamble Démontez

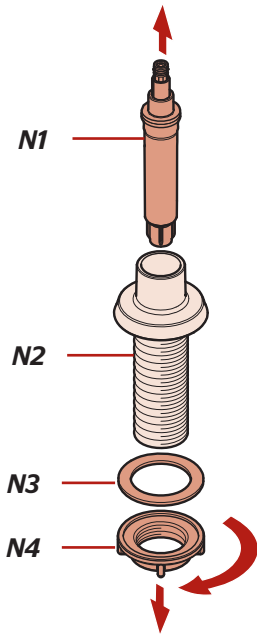

5B

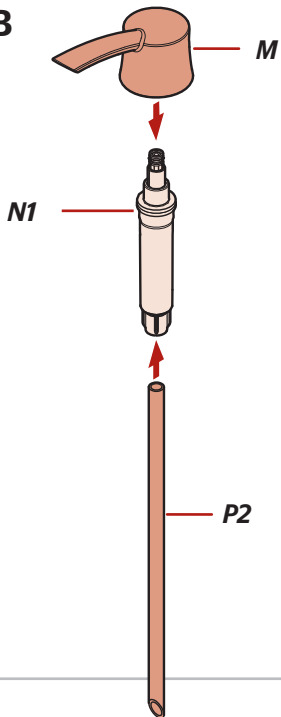

5C

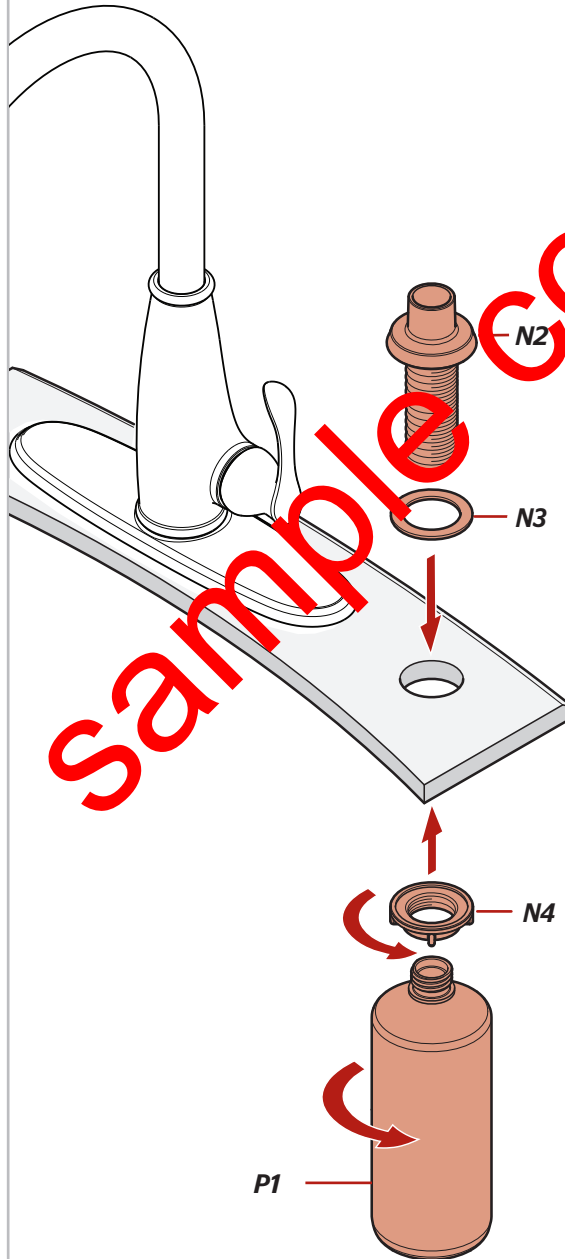

5D

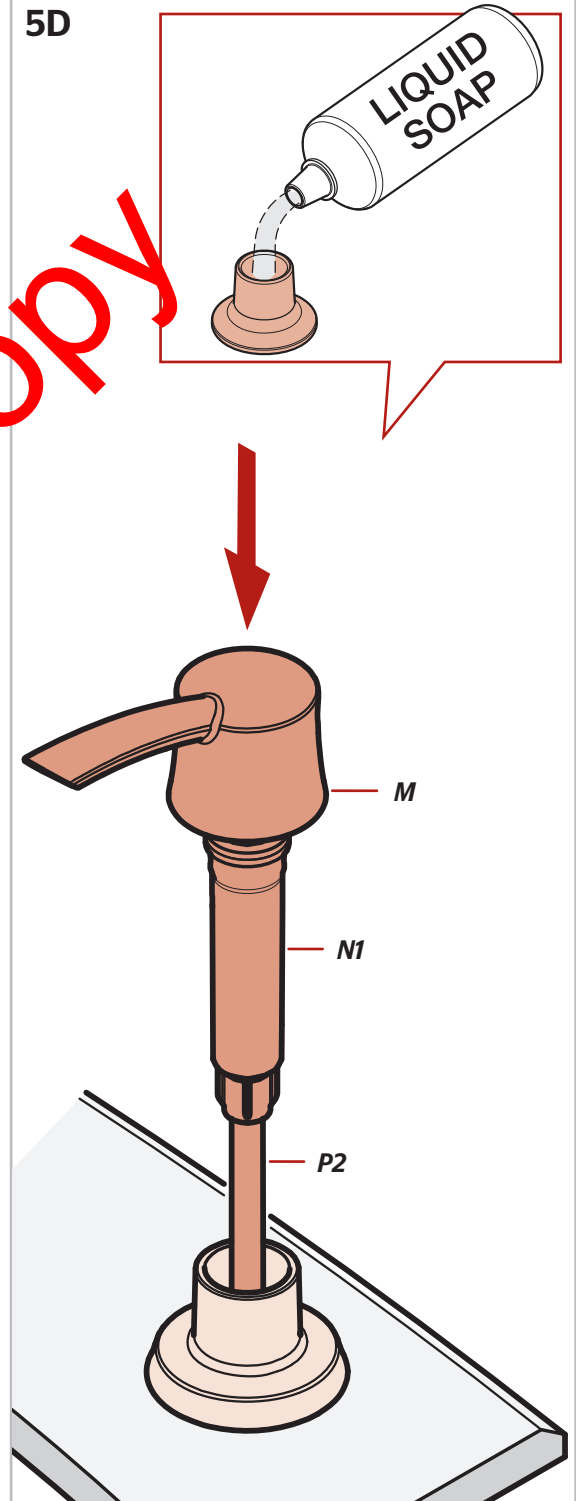

sample copy

6 Turn On Water & Confirm Proper Installation

Active el suministro de agua y confirme que la instalación está adecuadamente efectuada
Ouvrez l'eau et confirmez que l'installation est correcte

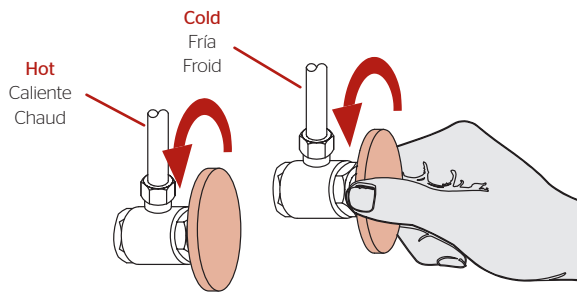

Check for leaks above and below the sink.

Revise si hay fugas encima y debajo del fregadero

Vérifiez s'il y a des fuites au dessus ainsi qu'au dessous de l'évier.

7 Flush the Faucet Enjuague el grifo Rincez le robinet

No Parts Required for This Step
No se necesitan piezas para este paso
Pas de pièces nécessaires pour cette étape

7A

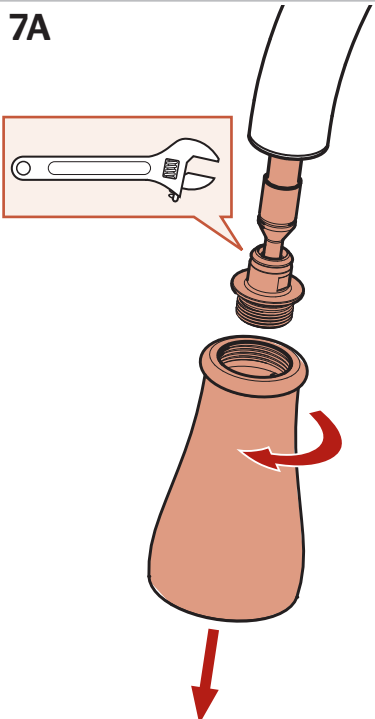

7B

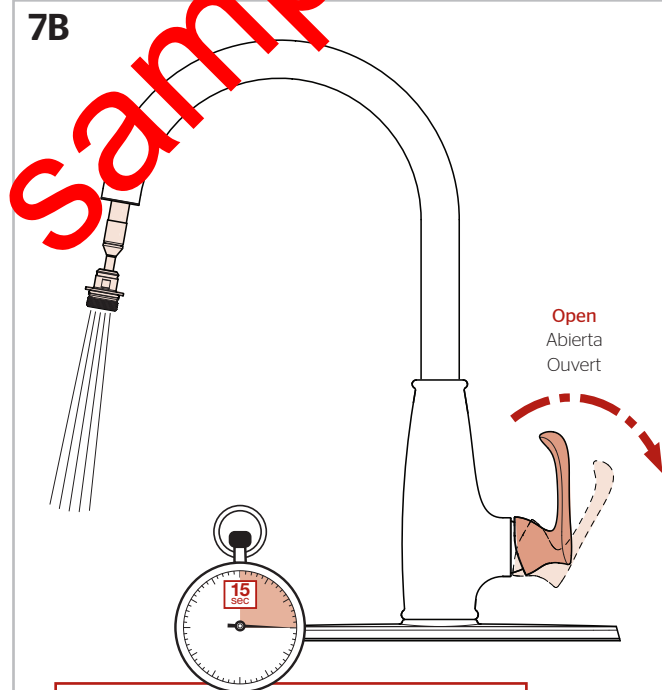

Allow full hot & full cold water to run for at least 15 seconds each.

Deje correr el agua caliente y fría durante al menos 15 segundos cada una.

Permettez à l'eau chaude et l'eau froide de couler au moins 15 secondes chacun.

7C

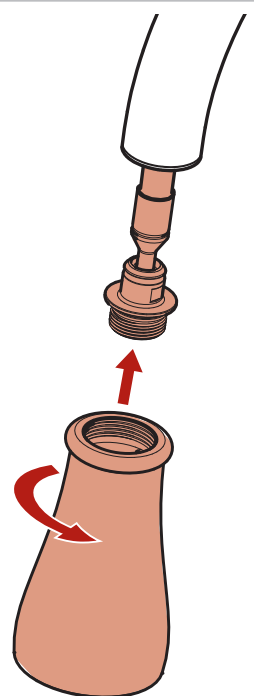

8

Faucet Functions

Funciones del grifo

Fonctions du robinet

8A



To activate the spray mode, press Button (A). By pressing Button (B), the spray pattern will change between spray and stream while the faucet is in operation. By holding Button (B), the water flow will pause. The water flow will resume once Button (B) is released.

Note: The faucet will always turn on in regular stream mode.

Para activar el modo del aerosol, presione el botón (A). Presionando el botón (B), el patrón de aerosol cambia entre el aerosol y la corriente mientras que el grifo está en la operación. Al sostener el botón (B), el flujo del agua se parará. El flujo del agua se reanuda una vez que se libera el botón (B).

Nota: El grifo siempre se abrirá en el modo de flujo continuo.

Pour activer le mode de pulvérisation, appuyez sur le bouton (A). En appuyant sur le bouton (B), le jet va changer entre pulvérisation et écoulement tandis que le robinet est en marche. En maintenant le bouton (B), le débit d'eau se met en pause. Le débit d'eau reprendra une fois le bouton (B) est libéré.

Remarque : Le robinet s'ouvre toujours en mode flux régulier.

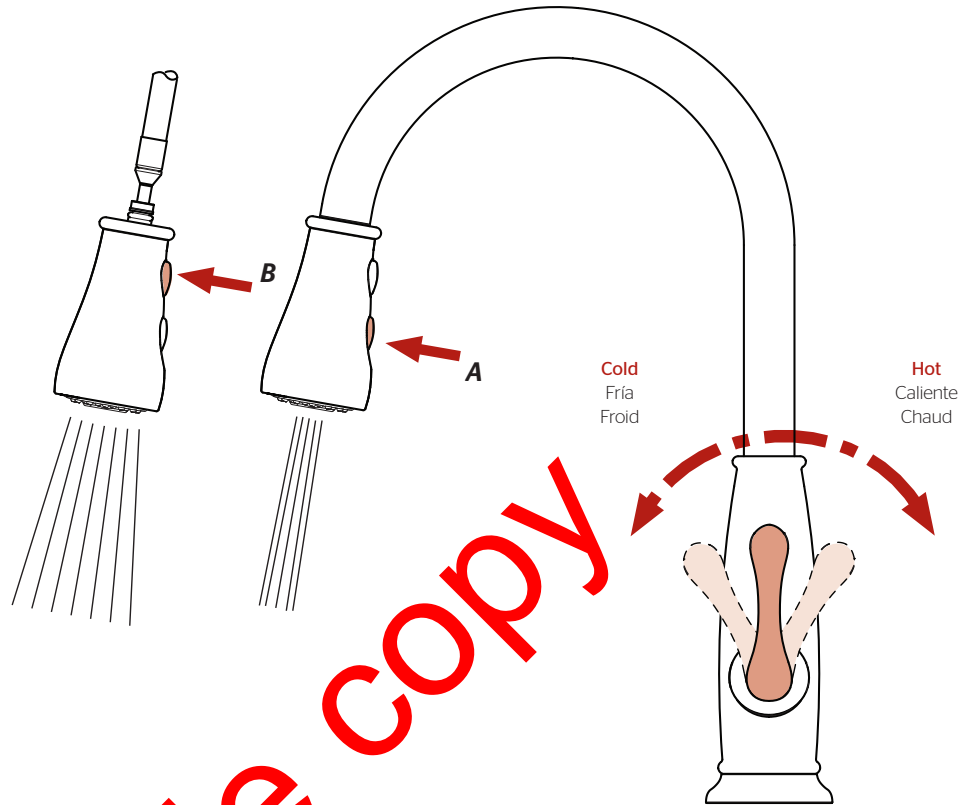

8B

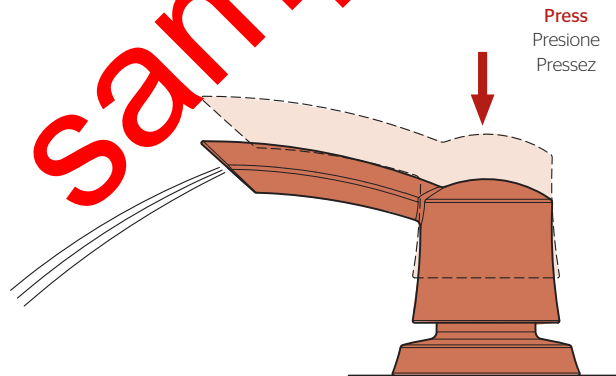
**For Additional Installation Help:**

Para la instalación adicionales de ayuda:
Pour aider à l'installation supplémentaires:

Price Pfister

1-800-PFAUCET (732-8238)
pfisterfaucets.com