

Type	-10	-28	-31
P9200	<input type="checkbox"/>	<input type="checkbox"/>	<input type="checkbox"/>
P9201	<input type="checkbox"/>	<input type="checkbox"/>	<input type="checkbox"/>
P9202	<input type="checkbox"/>	<input type="checkbox"/>	<input type="checkbox"/>

Catalog No.	Finish			Lamping	Dimensions (Inches)	
	Polished Brass	White	Black		A	B
P9200	N/A	-28	-31	75PAR16/50R/PAR20	3-1/2	7-5/8
P9201	-10	-28	-31	75PAR30/65BR30	4-3/8	8-3/4
P9202	N/A	-28	-31	300BR40/250PAR38	5-5/8	10-7/8

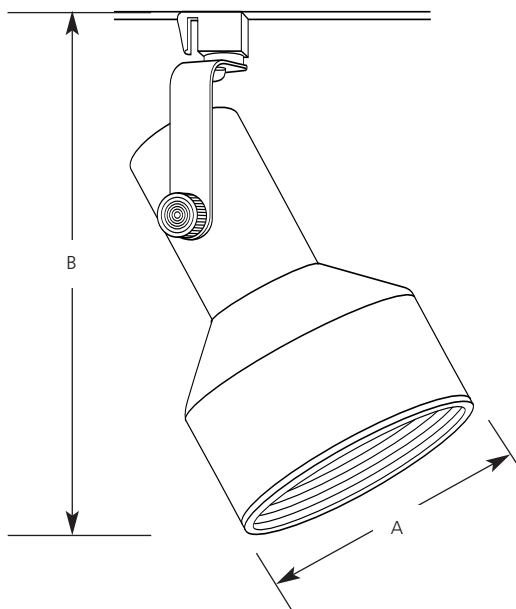

Specifications:

Track Lock Up

- For use with Alpha (P9100 Series) track
- Polarity oriented
- Quarter-turn locking action
- Tab lock to track to prevent accidental removal

- White baffle option
 - P9200 uses a P9118-28 white option
 - P9201 uses a P9119-28 white option
 - P9202 uses a P9120-28 white option

Track Head Support

- Steel half yoke
- 358-degree horizontal rotation
- P9200 & P9201 have self-locking pivot for vertical head positioning
- P9202 has external lock nut for vertical head positioning

Accessories

- Barn doors
 - P9200 order P8513
 - P9201 order P8514
 - P9202 order P8515

Track Head

- One piece steel construction
- Socket mount – two screws to prevent turning
- Porcelain socket with nickel-plated brass screw shell

Labeling

- UL-CUL dry location listed

Photometrics

- Refer to Lamp Application Data for:
 - R20, PAR20 & PAR16
 - BR30 & PAR30
 - PAR38 & BR40

Baffle

- Furnished with phenolic black baffle
- Spring clip retention

R20, PAR16 and PAR20 Lamp Application Data

Figure 1
Single lampholder

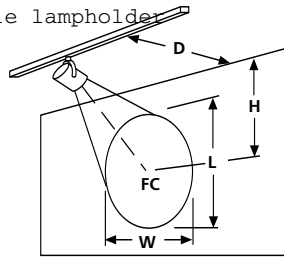
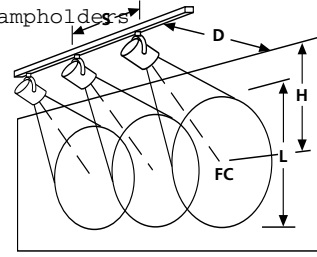

Figure 2
Multiple lampholders



R20 Flood Lamps



Walls and Vertical Objects													Horizontal Surfaces			
H	F.C.	L	W	S	F.C.	L	W	S	F.C.	L	W	S	Clg. Ht.	F.C.	Dia. & Spacing	
				D = 2 FT				D = 3 FT				D = 4 FT				
30R20FL	2	27	2.3	1.5	1.4	19	2.4	1.9	1.8	13	2.7	2.4	2.2	8	10	2.8
CBCP - 300 Beam - 30 deg.	3	13	4.2	1.9	1.8	12	3.5	2.3	2.1	10	3.5	2.7	2.4	9	7	3.4
	4	7	7.5	2.4	2.2	7	5.1	2.7	2.4	7	4.6	3.0	2.8	10	5	3.9
50R20FL	2	47	4.0	2.3	1.9	35	3.9	3.0	2.5	25	4.3	3.7	3.1	8	18	4.2
CBCP - 550 Beam - 45 deg.	3	23	8.8	3.0	2.5	22	6.0	3.5	2.9	18	5.7	4.1	3.4	9	13	5
	4	12	26.2	3.7	3.1	13	9.9	4.1	3.4	12	8.0	4.7	3.9	10	10	5.7
P75R20	2	57	4.0	2.3	1.9	42	3.9	3.0	2.5	29	4.3	3.7	3.1	8	21	4.2
CBCP - 650 Beam - 45 deg.	3	28	8.8	3.0	2.5	26	6.0	3.5	2.9	21	5.7	4.1	3.4	9	15	5.0
	4	15	26.2	3.7	3.1	16	9.9	4.1	3.4	14	8.0	4.7	3.9	10	12	5.7

PAR16 & PAR20 Flood Lamps



PAR16



PAR20

Walls and Vertical Objects													Horizontal Surfaces			
H	F.C.	L	W	S	F.C.	L	W	S	F.C.	L	W	S	Clg. Ht.	F.C.	Dia. & Spacing	
				D = 2 FT				D = 3 FT				D = 4 FT				
45PAR16NFL	2	124	2.0	1.4	1.3	90	2.1	1.7	1.6	63	2.4	2.1	2.0	8	46	2.6
CBCP - 1,400 Beam - 27 deg.	3	60	3.6	1.7	1.6	55	3.1	2.0	1.9	45	3.1	2.4	2.2	9	33	3.0
	4	31	6.2	2.1	2.0	34	4.5	2.4	2.2	31	4.1	2.7	2.5	10	25	3.5
50PAR20NFL	3	60	4.2	1.9	1.8	55	3.5	2.3	2.1	45	3.5	2.7	2.4	8	46	2.8
CBCP - 1,400 Beam - 30 deg.	4	31	7.5	2.4	2.2	34	5.1	2.7	2.4	31	4.6	3.0	2.8	9	33	3.4
	5	18	14.1	2.9	2.6	21	7.6	3.1	2.8	21	6.2	3.4	3.1	10	25	3.9
60/75PAR16NFL	3	85	3.6	1.7	1.6	79	3.1	2.0	1.9	64	3.1	2.4	2.2	8	66	2.6
CBCP - 2,000 Beam - 27 deg.	4	45	6.2	2.1	2.0	48	4.5	2.4	2.2	44	4.1	2.7	2.7	9	48	3.0
	5	29	10.9	2.6	2.4	30	6.5	2.8	2.6	31	5.4	3.1	3.1	10	36	3.5

PAR16 & PAR20 Spot Lamps



PAR16



PAR20

Walls and Vertical Objects													Horizontal Surfaces			
H	F.C.	L	W	S	F.C.	L	W	S	F.C.	L	W	S	Clg. Ht.	F.C.	Dia. & Spacing	
				D = 2 FT				D = 3 FT				D = 4 FT				
45PAR16NSP	4	112	1.8	0.8	0.8	120	1.5	0.9	0.9	110	1.4	1.0	1.0	8	89	1.3
CBCP - 5,000 Beam - 10 deg.	5	64	2.7	0.9	0.9	76	2.0	1.0	1.0	76	1.8	1.1	1.1	10	55	1.7
	6	39	3.8	1.1	1.1	50	2.7	1.2	1.2	53	2.3	1.3	1.2	12	38	2.0
50PAR20NSP	4	149	1.3	0.8	0.8	137	1.3	0.9	0.9	118	1.3	1.0	1.0	10	110	1.2
CBCP - 6,200 Beam - 9 deg.	6	62	2.4	1.1	1.0	66	2.1	1.1	1.1	73	1.8	1.2	1.2	12	69	1.5
	8	30	4.0	1.3	1.3	35	3.2	1.4	1.4	37	2.8	1.5	1.5	14	48	1.8
60/75PAR16NSP	4	180	1.5	0.9	0.9	166	1.4	1.0	1.0	143	1.4	1.1	1.1	10	133	1.3
CBCP - 7,500 Beam - 10 deg.	6	75	2.7	1.2	1.2	80	2.3	1.3	1.2	89	2.0	1.3	1.3	12	83	1.7
	8	36	4.5	1.5	1.5	42	3.6	1.6	1.5	45	3.2	1.7	1.6	14	57	2.0

Walls and Vertical Objects

H	Height from ceiling to center of beam
D	Distance from fixture to wall
F.C.	Footcandles at center of beam
L	Length of effective lighted area
W	Width of effective lighted area
S	Spacing of multiple fixtures to effectively light wall

Horizontal Surfaces

Clg. Ht.	Height from floor to ceiling
F.C.	Footcandles 30" from floor (work plane)
Dia. & Spacing	Diameter of effective lighted area and spacing to effectively light the horizontal surface

CBCP - Center Beam Candlepower

BR30 and PAR30 Lamp Application Data

Figure 1
Single lampholder

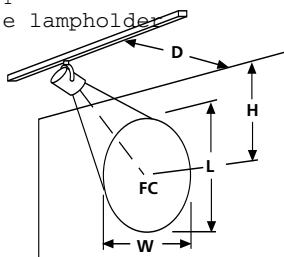
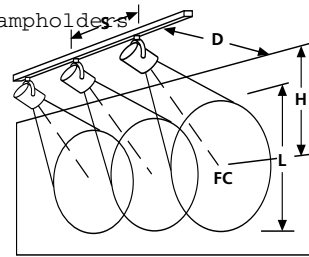

Figure 2
Multiple lampholders



BR30 Flood Lamp



BR30 Spot Lamp



PAR30
Flood Lamps



PAR30
Spot Lamps



Walls and Vertical Objects														Horizontal Surfaces		
H	F.C.	L	W	S	F.C.	L	W	S	F.C.	L	W	S	Clg. Ht.	F.C.	Dia. & Spacing	
D = 2 FT				D = 3 FT				D = 4 FT								
65BR30FL	2	46	5.7	2.9	2.3	34	5.1	3.8	2.9	23	5.6	4.7	3.6	8	17	5.1
CBCP - 525	3	22	17.3	3.8	2.9	21	8.6	4.4	3.4	17	12.0	5.2	4.0	9	12	6
Beam - 55 deg.	4	12	*	4.7	3.6	13	16.7	5.2	4.0	11	11.4	5.9	4.5	10	9	6.9
Walls and Vertical Objects														Horizontal Surfaces		
H	F.C.	L	W	S	F.C.	L	W	S	F.C.	L	W	S	Clg. Ht.	F.C.	Dia. & Spacing	
D = 2 FT				D = 3 FT				D = 4 FT								
65BR30SP	3	69	2.5	1.3	1.2	64	2.2	1.5	1.4	52	2.2	1.8	1.7	8	54	1.9
CBCP - 1625	4	36	4.0	1.6	1.5	39	3.1	1.8	1.7	36	2.9	2.0	1.9	9	38	2.3
Beam - 20 deg.	5	21	6.3	1.9	1.8	25	4.4	2.1	2.0	25	3.8	2.3	2.2	10	29	2.6
Walls and Vertical Objects														Horizontal Surfaces		
H	F.C.	L	W	S	F.C.	L	W	S	F.C.	L	W	S	Clg. Ht.	F.C.	Dia. & Spacing	
D = 2 FT				D = 3 FT				D = 4 FT								
50PAR30/HIR/FL	3	64	5.3	2.3	2.0	59	4.2	2.7	2.4	48	4.2	3.2	2.8	8	50	3.3
CBCP - 1500	4	34	10.4	2.8	2.5	36	6.4	3.2	2.8	33	5.6	3.6	3.1	9	36	3.9
Beam - 35 deg.	5	19	24.2	3.4	3.0	23	9.9	3.7	3.2	23	7.6	4.0	3.6	10	27	4.5
50PAR30FL	3	60	5.3	2.3	2.0	55	4.2	2.7	2.4	45	4.2	3.2	2.8	8	46	3.3
CBCP - 1400	4	31	10.4	2.8	2.5	34	6.4	3.2	2.8	31	5.6	3.6	3.1	9	33	3.9
Beam - 35 deg.	5	18	24.2	3.4	3.0	21	9.9	3.7	3.2	21	7.6	4.0	3.6	10	25	4.5
75PAR30FL	3	85	5.8	2.4	2.1	79	4.5	2.8	2.5	64	4.5	3.3	2.9	8	66	3.5
CBCP - 2000	4	45	12.1	3.0	2.6	48	6.9	3.3	2.9	44	6.0	3.8	3.3	9	47	4.1
Beam - 35 deg.	5	26	32.3	3.6	3.1	30	11.0	3.9	3.4	31	8.3	4.3	3.7	10	36	4.8
75PAR30FL-L	3	133	3.2	1.6	1.5	122	2.8	1.9	1.8	90	2.9	2.2	2.1	8	102	2.4
CBCP - 3100	4	70	5.5	2.0	1.9	74	4.0	2.2	2.1	68	3.7	2.5	2.3	9	74	2.8
Beam - 25 deg.	5	40	9.3	2.4	2.2	47	5.8	2.6	2.4	40	4.9	2.8	2.7	10	55	3.2
Walls and Vertical Objects														Horizontal Surfaces		
H	F.C.	L	W	S	F.C.	L	W	S	F.C.	L	W	S	Clg. Ht.	F.C.	Dia. & Spacing	
D = 3 FT				D = 4 FT				D = 5 FT								
50PAR30/HIR/NSP	4	313	1.3	0.8	0.8	287	1.3	0.9	0.9	247	1.3	1.0	1.0	12	144	1.5
CBCP - 13,000	6	130	2.4	1.1	1.0	139	2.1	1.1	1.1	154	1.8	1.2	1.2	16	71	2.1
Beam - 9 deg.	8	63	4.0	1.3	1.3	73	3.2	1.4	1.4	77	2.8	1.5	1.5	20	42	2.7
50PAR20NSP	4	166	1.5	0.9	0.9	152	1.4	1.0	1.0	131	1.4	1.1	1.1	10	123	1.3
CBCP - 6,900	6	69	2.7	1.2	1.2	74	2.3	1.3	1.2	81	2.0	1.3	1.3	12	76	1.7
Beam - 10 deg.	8	33	4.5	1.5	1.5	39	3.6	1.6	1.5	41	3.2	1.7	1.6	14	52	2.0
75PAR30NSP	4	313	1.5	0.9	0.9	287	1.4	1.0	1.0	247	1.4	1.1	1.1	10	231	1.3
CBCP - 13,000	6	130	2.7	1.2	1.2	139	2.3	1.3	1.2	154	2.0	1.3	1.3	14	98	2.0
Beam - 10 deg.	8	63	4.5	1.5	1.5	73	3.6	1.6	1.5	77	3.2	1.7	1.6	18	54	2.7
75PAR30NSP-L	4	217	1.5	0.9	0.9	199	1.4	1.0	1.0	171	1.4	1.1	1.1	10	160	1.3
CBCP - 9,000	6	90	2.7	1.2	1.2	96	2.3	1.3	1.2	107	2.0	1.3	1.3	14	68	2.0
Beam - 10 deg.	8	44	4.5	1.5	1.5	51	3.6	1.6	1.5	53.3	3.2	1.7	1.6	18	37	2.7

Walls and Vertical Objects

H	Height from ceiling to center of beam
D	Distance from fixture to wall
F.C.	Footcandles at center of beam
L	Length of effective lighted area
W	Width of effective lighted area
S	Spacing of multiple fixtures to effectively light wall

Horizontal Surfaces

Clg. Ht.	Height from floor to ceiling
F.C.	Footcandles 30" from floor (work plane)
Dia. & Spacing	Diameter of effective lighted area and spacing to effectively light the horizontal surface

CBCP - Center Beam Candlepower
*L is height of wall

PAR38 and BR40 Lamp Application Data

Figure 1

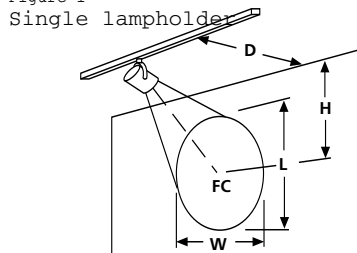
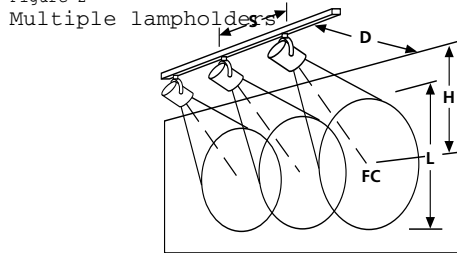

Figure 2



BR40
Flood Lamps



BR40
Spot Lamps



PAR38
Flood Lamps



PAR38
Spot Lamps



Walls and Vertical Objects													Horizontal Surfaces		
H	F.C.	L	W	S	F.C.	L	W	S	F.C.	L	W	S	Clg. Ht.	F.C.	Dia. & Spacing

	D = 2 FT					D = 3 FT					D = 4 FT							
120BR40FL	2	88	6.9	3.3	2.4	64	5.9	4.2	3.1	45	6.3	5.2	3.8	8	33	5.5		
CBCP - 1,000	3	43	29.9	4.2	3.1	39	10.4	4.9	3.6	32	8.9	5.8	4.3	9	24	6.5		
Beam - 60 deg.	4	22	*	5.2	3.8	24	23.5	5.8	4.3	22	13.9	6.5	4.8	10	18	7.5		
300R40FL	3	124	*	12.5	6.7	114	*	14.7	7.8	93	*	17.3	9.2	8	96	9.5		
CBCP - 2,900	4	65	*	15.5	8.3	70	*	17.3	9.2	64	*	19.6	10.5	10	52	13.0		
Beam - 120 deg.	5	37	*	18.7	9.9	44	*	20.2	10.8	44	*	22.2	11.8	12	32	16.5		
	D = 3 FT					D = 4 FT					D = 5 FT							
120BR40SP	4	111	3.1	1.8	1.7	102	2.9	2.0	1.9	87	3.0	2.3	2.2	10	82	2.6		
CBCP - 4,600	6	46	6.0	2.4	2.3	49	4.9	2.5	2.4	54	4.1	2.6	2.5	12	51	3.3		
Beam - 20 deg.	8	22	11.0	3.0	2.9	26	8.0	3.2	3.0	27	6.8	3.3	3.2	14	35	4.0		
300R40SP	4	337	7.9	3.6	3.1	309	6.7	4.1	3.5	266	6.5	4.7	4.0	10	249	5.1		
CBCP - 14,000	6	140	23.1	4.9	4.2	149	13.5	5.2	4.5	165	9.8	5.5	4.7	12	155	6.5		
Beam - 40 deg.	8	68	*	6.2	5.3	79	30.8	6.5	5.6	83	19.6	6.9	5.8	14	106	7.9		
	D = 2 FT					D = 3 FT					D = 4 FT							
75PAR38FL	3	171	3.2	1.6	1.5	157	2.8	1.9	1.8	128	2.9	2.2	2.1	8	132	2.4		
CBCP - 4,000	4	90	5.5	2.0	1.9	96	4.0	2.2	2.1	88	3.7	2.5	2.3	9	95	2.8		
Beam - 25 deg.	5	51	9.3	2.4	2.2	60	5.8	2.6	2.4	61	4.9	2.8	2.7	10	71	3.2		
90PAR38FL	3	222	2.7	1.5	1.4	161	2.8	1.9	1.8	122	3.0	2.3	2.1	8	136	2.4		
CBCP - 4,100	4	92	5.5	2.0	1.9	78	4.9	2.4	2.2	76	4.3	2.7	2.5	9	97	2.8		
Beam - 25 deg.	5	45	11.0	2.5	2.4	41	8.3	3.0	2.8	38	7.2	3.3	3.1	10	73	3.2		
120PAR38FL	3	214	4.2	1.9	1.8	196	3.5	2.3	2.1	160	3.5	2.7	2.4	8	165	2.8		
CBCP - 5,000	4	112	7.5	2.4	2.2	120	5.1	2.7	2.4	110	4.6	3.0	2.8	9	118	3.4		
Beam - 30 deg.	5	64	14.1	2.9	2.6	76	7.6	3.1	2.8	76	6.2	3.4	3.1	10	89	3.9		
150PAR38FL	3	193	4.2	1.9	1.8	176	3.5	2.3	2.1	144	3.5	2.7	2.4	8	148.5	2.8		
CBCP - 4,500	4	101	7.5	2.4	2.2	108	5.1	2.7	2.4	99	4.6	3.0	2.8	9	106.2	3.4		
Beam - 30 deg.	5	58	14.1	2.9	2.6	68	7.6	3.1	2.8	68	6.2	3.4	3.1	10	80.1	3.9		
250PAR38FL	3	132	5.3	2.3	2.0	122	4.2	2.7	2.4	99	4.2	3.2	2.8	8	102	3.3		
CBCP - 3,100	4	70	10.4	2.8	2.5	75	6.4	3.2	2.8	69	5.6	3.6	3.1	9	73	3.9		
Beam - 35 deg.	5	40	24.2	3.4	3.0	47	9.9	3.7	3.2	47	7.6	4.0	3.6	10	55	4.5		
	D = 3 FT					D = 4 FT					D = 5 FT							
75PAR38SP	4	313	1.3	0.8	0.8	287	1.3	0.9	0.9	247	1.3	1.0	1.0	10	231	1.2		
CBCP - 13,000	6	130	2.4	1.1	1.0	139	2.1	1.1	1.1	154	1.8	1.6	1.2	12	144	1.5		
Beam - 9 deg.	8	63	4.0	1.3	1.3	73	3.2	1.4	1.4	77	2.8	2.0	1.5	14	98	1.8		
90PAR38SP	4	385	1.5	0.9	0.9	354	1.4	1.0	1.0	304	1.4	1.1	1.1	10	284	1.3		
CBCP - 16,000	6	160	2.7	1.2	1.2	171	2.3	1.3	1.2	189	2.0	1.3	1.3	12	121	2.0		
Beam - 10 deg.	8	77	4.5	1.5	1.5	90	3.6	1.6	1.5	95	3.2	1.7	1.6	14	67	2.7		
	D = 4 FT					D = 5 FT					D = 6 FT							
120PAR38SP	8	338	1.8	1.0	1.0	354	1.6	1.1	1.1	330	1.6	1.2	1.2	16	137	2.1		
CBCP - 25,000	10	140	3.2	1.4	1.4	171	2.6	1.4	1.4	205	2.1	1.4	1.4	18	104	2.4		
Beam - 9 deg.	12	68	5.3	1.8	1.8	90	4.0	1.8	1.7	103	3.4	1.8	1.8	20	82	2.7		
150PAR38SP	8	244	2.4	1.4	1.4	255	2.1	1.5	1.5	238	2.1	1.6	1.6	12	199	2.0		
CBCP - 18,000	10	101	4.4	1.9	1.8	123	3.5	1.9	1.9	148	2.9	1.9	1.9	14	136	2.4		
Beam - 12 deg.	12	49	7.4	2.4	2.4	65	5.5	2.3	2.3	74	4.6	2.4	2.3	16	99	2.8		

Walls and Vertical Objects

H	Height from floor to center of beam
D	Distance from fixture to wall
F.C.	Footcandles at center of beam
L	Length of effective lighted area
W	Width of effective lighted area
S	Spacing of multiple fixtures to effectively light wall

Horizontal Surfaces

Clg. Ht.	Height from floor to ceiling
F.C.	Footcandles 30" from floor (work plane)
Dia. & Spacing	Diameter of effective lighted area and spacing to effectively light the horizontal surface

CBCP - Center Beam Candlepower
*L is height of wall