



# H-Series

Cylindrical Interconnected Locks





## Contents

4-5	Mechanical Lock Guide
6-7	H-Series Introduction
8	Performance Features
9	Exploded View
10	Knob and Lever Designs
11	Finishes and Door Handing
12-13	Lock Functions
14	Cylinders and Key Systems
15	Standard Cylinders
15	Primus High Security Cylinders
18	Latches and Deadbolts
19	Strikes
20	Specifications and Certifications
21	Ordering Guidelines

Pictured here: Levon interconnected lock with full escutcheon shown in 626 Satin Chrome

Cover photo: Levon interconnected lock shown in 626 Satin Chrome





## Put Your Trust in the Name You Know

For more than 85 years Schlage® has been providing innovative security solutions for schools, hospitals, hotels, condominiums and a host of other commercial buildings. Today, Schlage is at the forefront of cutting-edge technology such as wireless security products, biometrics and CCTV. With a wide range of products, styles and finishes, Schlage has what you need no matter how demanding your project specifications may be. And we stand behind every lock we make with some of the best after-sales service in the business. It's this commitment to design, performance and technology that ensures you can stand behind our products too.

# Schlage Commercial Locks



**Tubular Locks**

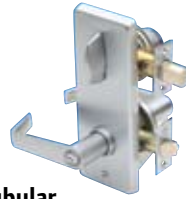

**Tubular Interconnected Locks**



**Cylindrical Locks**



**Cylindrical Interconnected Locks**

S-Series	S200-Series	A-Series	H-Series
GRADE 2	GRADE 2	GRADE 2	
<b>Security Level:</b>			
ANSI/BHMA Certified A156.2-2003 Exceeds 400,000 ANSI Cycles Light Traffic	ANSI/BHMA Certified A156.12-2005 Exceeds 400,000 ANSI Cycles Medium Traffic	ANSI/BHMA Certified A156.2-2003 Exceeds 400,000 ANSI Cycles Medium Traffic	ANSI/BHMA Certified - Exceeds 400,000 ANSI Cycles Medium Traffic
<b>Typical Applications:</b>			
- Interior - Retrofit	Exterior Interior New Construction Retrofit	Exterior Interior New Construction Retrofit	Exterior Interior - Retrofit
<b>Functions Available:</b>			
6 Functions - -	5 Functions - -	11 Functions - -	5 Functions - -
<b>Design Options:</b>			
8 Finishes 4 Lever Styles - 3 Decorative Options 1 Matching Rose - Tactile Warning Available	8 Finishes 4 Lever Styles - 3 Decorative Options 1 Matching Rose 1 Interior Escutcheon -	9 Finishes 1 Lever Style 4 Knob Styles 3 Decorative Options 1 Matching Rose - -	7 Finishes 1 Lever Style 2 Knobs Styles 2 Decorative Options 1 Matching Rose 1 Interior Escutcheon -
<b>Often Used In:</b>			
Commercial Multi-Family Office	Commercial Multi-Family Office	Commercial Healthcare Hospitality Office Retail	Commercial Govt/Military Multi-Family

Not all functions and finishes available with all products. Please consult your Ingersoll Rand representative for details.



**Cylindrical Locks**



**Deadbolts**



**Cylindrical Locks**



**Cylindrical Locks**



**Mortise Locks**

AL-Series	B-Series		D-Series	ND-Series	L-Series
GRADE 2	GRADE 2	GRADE 1	GRADE 1	GRADE 1	GRADE 1
<b>Security Level:</b>					
ANSI/BHMA Certified A156.2-2003 Exceeds 400,000 ANSI Cycles Medium Traffic	ANSI/BHMA Certified A156.5-2001 Exceeds 150,000/250,000 ANSI Cycles High	ANSI/BHMA Certified A156.2-2003 Exceeds 800,000 ANSI Cycles High Traffic	ANSI/BHMA Certified A156.2-2003 Exceeds 800,000 ANSI Cycles Heavy Duty Traffic	ANSI/BHMA Certified A156.13-2005 Exceeds 1,000,000 ANSI Cycles Heavy Duty Traffic	ANSI/BHMA Certified A156.13-2005 Exceeds 1,000,000 ANSI Cycles Heavy Duty Traffic
<b>Typical Applications:</b>					
Exterior Interior New Construction Retrofit	Exterior - New Construction Retrofit	Exterior Interior - Retrofit	Exterior Interior New Construction Retrofit	Exterior Interior New Construction Retrofit	Exterior Interior New Construction Retrofit
<b>Functions Available:</b>					
10 Functions - -	7 Functions - -	6 Functions - -	16 Functions 2 Electrified -	30 Functions 6 Electrified Vandlgard™ Available	53 Functions 4 Electrified Vandlgard™ Available
<b>Design Options:</b>					
8 Finishes 4 Lever Styles - 3 Decorative Options 1 Matching Rose - Tactile Warning Available	9 Finishes - - - - - Indicator Rose	8 Finishes - 3 Knob Styles 2 Decorative Options 1 Matching Rose - -	8 Finishes 5 Lever Styles - 4 Decorative Options 2 Matching Rose - Tactile Warning Available	10 Finishes 24 Lever Styles 2 Knob Styles 23 Decorative Options 4 Matching Roses 2 Escutcheons Tactile Warning Available	10 Finishes 24 Lever Styles 2 Knob Styles 23 Decorative Options 4 Matching Roses 2 Escutcheons Tactile Warning Available
<b>Often Used In:</b>					
Commercial Healthcare Hospitality Office Retail	Commercial/Institutional Govt/Military Heavy Duty Residential Hospitality Office Retail	Institutional Govt/Military Hospitality Retail	Institutional Education Healthcare Office Retail	Institutional Education Healthcare Office	Institutional Education Healthcare Office

This chart shows the most common uses/applications and these products are often used in other applications in addition to those listed.

Rev. 12/08



# H-Series

**Tough, dependable multi-family safety and security.**

Multi-family applications demand tough hardware that also provides quick, easy egress for guests or residents. Our H-Series is also well suited for small hotels and military housing, a choice of cylinders, and styles and finishes that fit your building's design.

Pictured here: Plymouth interconnected lock shown in 626 Satin Chrome



**We don't compromise on security.**

The safety and security of your clients' buildings is something we take very seriously. That's why every Schlage lock and deadbolt undergoes intensive testing:

- Cycle tests
- Resistance tests
- Door impact tests
- Warped door tests
- Bolt strength tests

We pay attention to these details so you can focus on creating a functional and aesthetically pleasing environment for your clients.



## Real Security is Knowing Exactly What You Want and Getting It

When you know exactly what you want, you don't want to waste time finding out whether it meets your project specifications. That's why we offer the world's largest team of hardware specification writers to help you and your clients turn your vision into reality. And when it comes to products, our commercial suiting options, wide variety of lever designs and rich selection of finishes give you the tools you need to make your projects perfect. You know what you want. With Schlage you can be sure you'll get it.

### **Safety, Security and Confidence**

When you choose a Schlage lock you can be sure you've done the job right the first time. After all, our products are among the most durable and dependable on the market today. Our locks are easy to install, and simple to repair and maintain. That means fewer callbacks for you and total safety and security for your customers.

# H-Series

In condominiums, apartments and small hotel/motel applications the H-Series interconnected lock delivers lasting performance, easy installation and a choice of finishes to fit the building's design.

Pictured here: Orbit interconnected lock shown in 626 Satin Chrome





# A tough, dependable lock.

- Heat-treated steel locking components for extra strength
- Independent heavy-duty lever torsion springs for durability and long life
- Non-handed levers for easy field installation
- Extra-strong Everest® patented keys standard for commercial applications

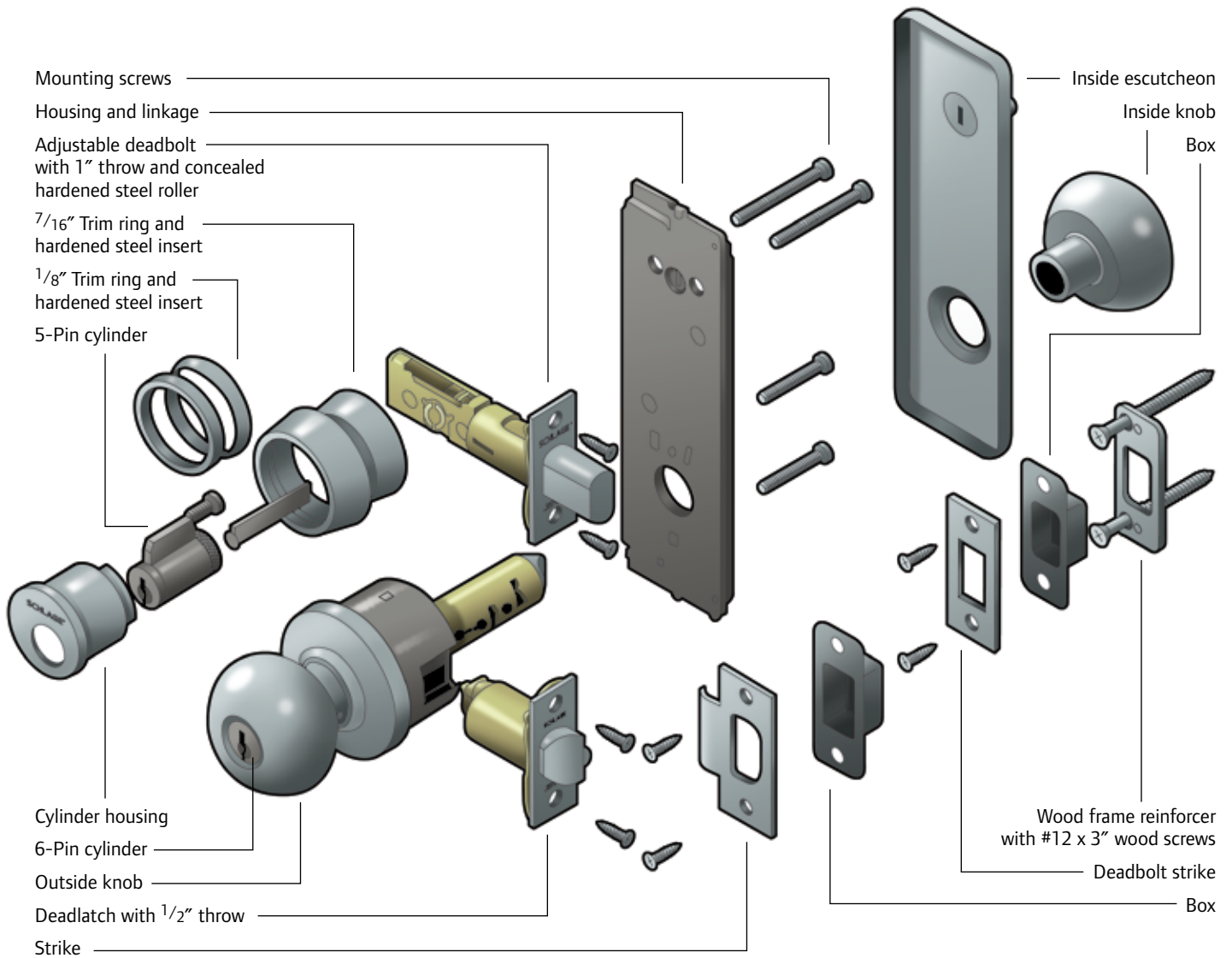

# Knob and Lever Designs

## Orbit

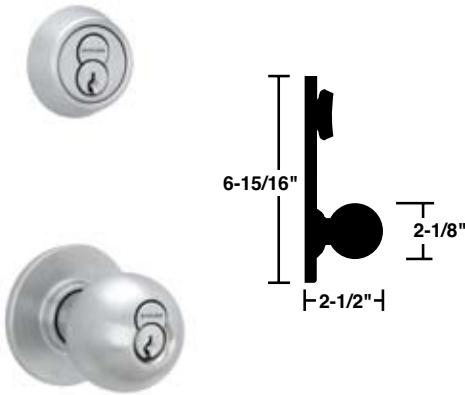

**Symbol:** ORB

**Material:** Wrought brass or bronze

● ○ Full size interchangeable core option available in H110, H153 and H180 functions.

## Levon



**Symbol:** LEV

Available inside only on H153, H180 and H185 functions only.

**Material:** Pressure cast zinc

● ♿

## Plymouth

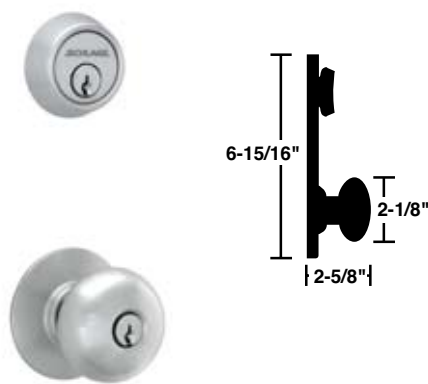

**Symbol:** PLY

**Material:** Wrought brass or bronze

● ○ Full size interchangeable core option available in H110 function only.

## Meteor Outside Escutcheon



**Order separately**

**Material:** Wrought brass or bronze

All designs shown in 626 Satin Chrome.

- = Standard cylinder.
- = FSIC - Full size interchangeable core option for Orbit design.
- ♿ = Complies with ADA Accessibility Guidelines.

# Knob and Lever Finishes

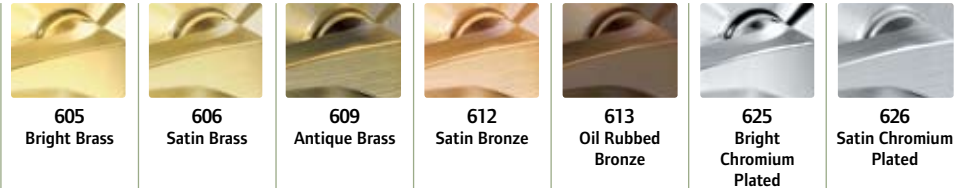

H-SERIES LOCKS							
Levon	•			•	•		•
Meteor	•	•	•	•	•	•	•
Orbit	•	•	•	•	•	•	•
Plymouth	•	•	•	•	•	•	•

# Door Handing

All Schlage locks are reversible. Hand information is necessary to ensure proper cylinder orientation in keyed functions, and finish of latchbolt and strike for locks that are to be installed on reverse bevel doors. Follow the diagram to correctly determine the hand of the door.

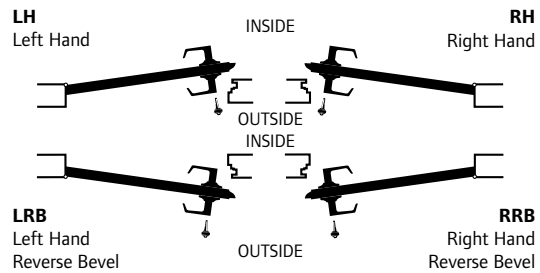

# ADA-Compliant Products



In compliance with the American National Standards Institute (ANSI A117.1) and the Americans with Disabilities Act (ADA), Schlage Lock Company offers a wide selection of locks designed for the needs of the physically challenged. This act is designed to provide protection for people with disabilities.

The intent of ADA is that owners of certain types of buildings must remove barriers and provide people with disabilities with access equal to, or similar to, that available to the general public.

Product information and specifications contained in this catalog are subject to change without notice. Please consult the factory.

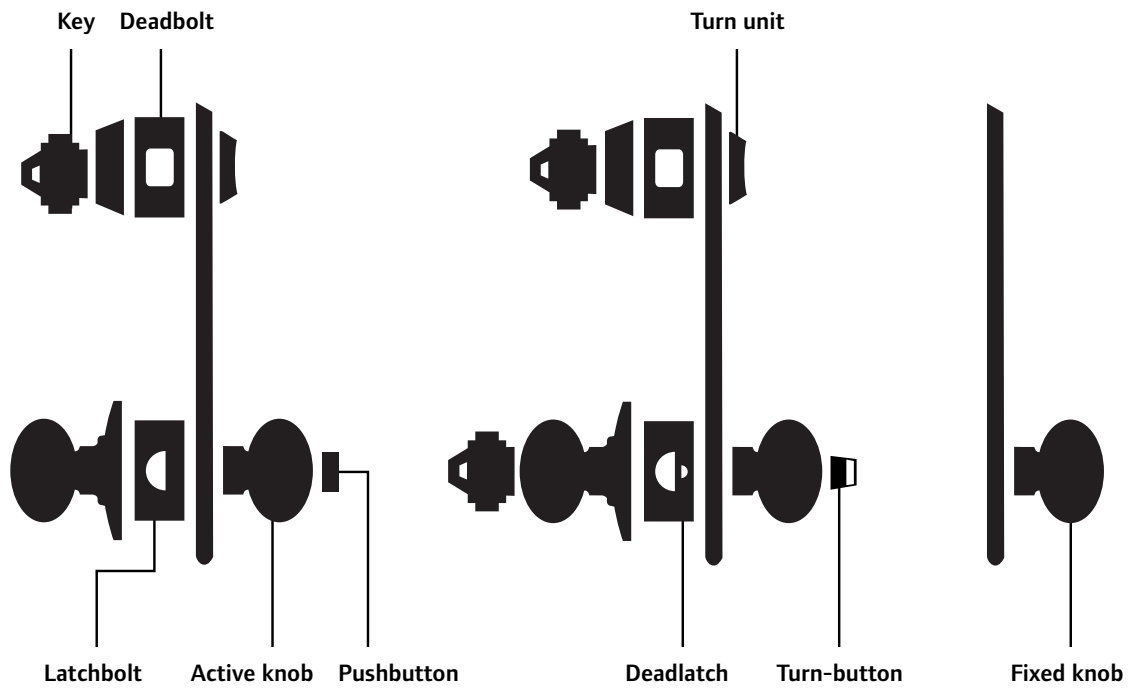
# H-Series Lock Functions | ANSI A156.2 Series



	Standard cylinder.
	FSIC - full size interchangeable core option for Orbit design.

## Keyed Functions

SCHLAGE ANSI

**H110 F95**

### Entrance, Single Locking

- Deadbolt thrown or retracted by key in upper cylinder from the outside or thumbturn inside.
- Latchbolt retracted by knob from either side.
- Turn inside knob or lever to simultaneously retract latchbolt and deadbolt for immediate exit.

Outside Inside

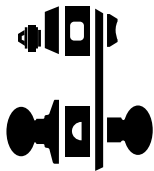

SCHLAGE ANSI

**H153 F97**

### Entrance, Double Locking

- Deadbolt thrown or retracted by key in upper cylinder from outside or thumbturn inside.
- Deadlatch is retracted by key in outside knob or by pushing turn-button in inside knob or lever.
- Outside knob may be fixed in locked position by rotating turn-button.
- Turn inside knob or lever to simultaneously retract deadbolt and deadlatch for immediate exit.

Outside Inside

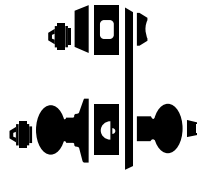

SCHLAGE ANSI

**H180**

### Storeroom Lock

- Deadbolt operated by key from outside or thumbturn inside.
- Bolt automatically deadlocks when fully thrown.
- Deadlatch retracted by key from outside.
- Inside knob simultaneously retracts both latch and deadbolt for immediate exit.
- Outside knob is always locked.

Outside Inside

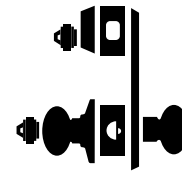

SCHLAGE ANSI

**H185 F100**

### Hotel/Motel Lock

- Deadbolt thrown or retracted by emergency master key in upper cylinder from outside or thumbturn inside.
- Deadlatch retracted by key in outside knob, except when the lock is in "shut-out" mode, by pushing button on inside knob or lever.
- Pushing button on inside knob or lever activates visual occupancy indicator.
- Only emergency master key operates outside knob when lock is in shut-out mode.
- Turn inside knob or lever to release shut-out mode and simultaneously retract deadbolt and latchbolt for immediate exit.

Outside Inside

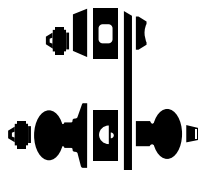

SCHLAGE ANSI

**H170**

### Inside Half Dummy Trim

- Snap-on rose and knob.
- Concealed mounting screws.

Outside Inside



# Cylinders and Key Systems

## New and existing key systems.

If you're implementing a completely new key system Schlage can help you design a system that can grow and change along with your needs, allowing you the flexibility to upgrade your security without the need to replace all your cylinders.

EVEREST	
What it operates	What it is
<ul style="list-style-type: none"> <li>Everest Primus XP cylinders</li> <li>Everest Restricted Security cylinders</li> <li>Everest Standard Security cylinders</li> </ul>	<p><b>UL437 Version</b></p> <ul style="list-style-type: none"> <li>UL437 versions provide drill and pick resistance and withstand physical attack</li> <li>High security cylinders have a second set of pins for added security</li> <li>Patented key control sold with various levels of geographic exclusivity</li> <li>Keys operate high security, as well as restricted security or standard security cylinders</li> <li>Available in standard and FSIC</li> </ul>
<ul style="list-style-type: none"> <li>Everest Primus XP cylinders</li> <li>Everest Restricted Security cylinders</li> <li>Everest Standard Security cylinders</li> </ul>	<p><b>Controlled Access</b></p> <ul style="list-style-type: none"> <li>Patented key control sold with various levels of geographic exclusivity</li> <li>High security cylinders have a second set of pins for added security and pick resistance</li> <li>Keys operate high security, as well as restricted security or standard security cylinders</li> <li>Available in standard and FSIC</li> </ul>
<ul style="list-style-type: none"> <li>Everest Restricted Security cylinders</li> </ul>	<ul style="list-style-type: none"> <li>Key distribution is restricted—duplication must be authorized</li> <li>End user's ID numbers are stamped on all keys, enabling Schlage to identify the source of any unauthorized keys</li> <li>Patent-protected keys are drop-shipped from the factory directly to an end-user specified location to guarantee exclusivity</li> <li>Available in standard, SFIC and FSIC</li> </ul>
<ul style="list-style-type: none"> <li>Everest Standard Security cylinders</li> </ul>	<ul style="list-style-type: none"> <li>Patented key blanks can be stored by commercial locksmiths and security dealers</li> <li>Keys can be duplicated without any paperwork or signature verification</li> <li>Sold only through commercial outlets</li> <li>Available in standard and FSIC</li> </ul>

## Existing key systems.

Schlage offers two key systems that are ideal for upgrading an existing key system and regaining control over key management. Our patent-protected cylinders help prevent unauthorized duplication and can be integrated into virtually any existing system.

CLASSIC	
What it is	What it operates
<p><b>UL437 Version</b></p> <ul style="list-style-type: none"> <li>UL437 versions provide drill and pick resistance and withstand physical attack</li> <li>High security cylinders have a second set of pins for added security</li> <li>Patented key control sold with various levels of geographic exclusivity</li> <li>Keys operate high security, as well as restricted security or standard security cylinders</li> <li>Available in standard and FSIC</li> </ul>	<ul style="list-style-type: none"> <li>Primus XP cylinders</li> <li>Classic cylinders</li> </ul>
<p><b>Controlled Access</b></p> <ul style="list-style-type: none"> <li>Patented key control sold with various levels of geographic exclusivity</li> <li>High security cylinders have a second set of pins for added security and pick resistance</li> <li>Keys operate high security, as well as restricted security or standard security cylinders</li> <li>Available in standard and FSIC</li> </ul>	<ul style="list-style-type: none"> <li>Primus XP cylinders</li> <li>Classic cylinders</li> </ul>
<p><b>PRIMUS XP</b></p> <p>HIGH SECURITY</p>	<ul style="list-style-type: none"> <li>High security cylinders have a second set of pins for added security and pick resistance</li> <li>Keys operate high security, as well as restricted security or standard security cylinders</li> <li>Available in standard and FSIC</li> </ul>
<p><b>CLASSIC</b></p> <p>BASIC SECURITY</p>	<ul style="list-style-type: none"> <li>Keys can be duplicated at most retail and commercial points of sale with no restrictions</li> <li>Recommended only for residential applications or existing commercial systems that cannot rekey</li> <li>Can be upgraded to Primus XP without rekeying the entire facility</li> <li>Available in standard and FSIC</li> </ul>

# Standard Cylinders

Schlage locks are provided with cylinders precision built to extremely close tolerances and the highest standards of accuracy. Using only solid brass plugs, extruded brass shells, phosphor bronze springs, and nickel silver keys and pins ensure long life and ease of operation.

Conventional cylinders are available in Classic keyways or in the newly patented Everest® keyways. Specify keyway to differentiate between Everest and Classic.

Example: C (Classic) vs. C123 (Everest).

## Standard Cylinders

Number		Description
Orbit Design	Plymouth Design	
21-002-122	21-002	6-Pin conventional (standard)
20-724-122-XP	20-724-XP	Primus XP high security
20-524-122-XP	20-524-XP	Primus XP UL437 Listed high security
21-003-168-XP	21-003-XP	Hotel Function (H185) with indicator

Available 606 and 626 finish only. Everest C123 keyway standard for commercial; C keyway standard for residential.

**Cylinder for Most Functions**

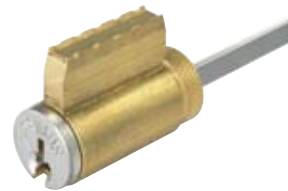

**Hotel Function Indicator Cylinder**



## Cylinders for Deadbolt (Top)

Cylinder Only	Cylinder & Housing	Description
22-001	22-017	5-Pin conventional (Residential standard)
22-002	22-019	6-Pin conventional (Commercial standard)
20-729-XP	20-730-XP	Primus XP high security
20-529-XP	20-530-XP	Primus XP UL437 Listed high security

**Cylinder only**



**Cylinder and housing**



## Primus High Security Cylinders

Primus high security cylinders are available to add patented key control and varying degrees of geographical exclusivity to most Schlage 6-pin key systems, whether Everest or Classic keyways.

In addition to a conventional pin tumbler mechanism, Primus cylinders incorporate a patented finger pin and sidebar design providing a “dual-locking” cylinder that is virtually pick-proof. Resistance to drilling and other physical attack is optional by specifying 20-500 Series UL437 Listed cylinders.

Classic Primus cylinders are recommended for upgrading existing Classic key systems. Due to its extended patent life, the newly designed Everest Primus is recommended for new key systems and for upgrading existing Everest® key systems. Specify keyway to differentiate between Everest and Classic.

Example: CP (Classic) vs. C123 (Everest).

See Schlage Cylinders, Keys and Key Control Catalog (SC-5293) for more details.

## Full Size Interchangeable Core 8

Schlage interchangeable core (IC) locksets allow immediate rekeying at the door simply by using the special control key to replace the core in seconds.

Only the Orbit knob is available with IC. Full size interchangeable cores can be integrated into any 5 or 6-pin Schlage key with no adverse affects on keying capacity.

To order complete locks with full size cores, add suffix **R**. Example: H153**R**. To order locks less core, change suffix to **J**. To order with full size construction core, change suffix to **T**.



### Orbit

**Symbol:** ORB

**Material:** Wrought brass or bronze

**Finishes:** 605, 606, 609, 610, 611, 612, 613, 616, 625, 626

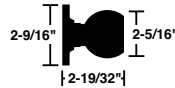

Design shown in 626 Satin Chrome



# Cores, and IC Cylinders and Parts

## Full Size Interchangeable Cores

Number	Description
23-030	Conventional core
20-740-XP	Primus XP high security core

Available 606 and 626 finish only. Everest C123 keyway standard for Commercial; C keyway standard for Residential.



**Full Size Core**

## IC Cylinders for Deadbolt (Top) Tailpiece not included.

Number	Description
22-061	Housing less core
22-064	Housing with conventional core
20-784	Housing with Primus core

Available 605, 606, 609, 610, 611, 612, 613, 616, 625, 626. Everest C123 keyway standard for Commercial; C keyway standard for Residential.

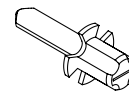
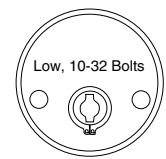
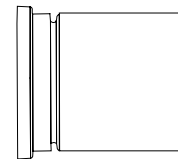
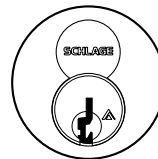

**Driver and Retainer for IC Knob**  
01-053



## IC Installation Tool

This tool is used to install the driver and retainer for full size IC in Schlage knobs and levers. Its other ends are designed to install and remove mortise cylinder housings and test mortise cylinder cam action for both small format and full size interchangeable core cylinders.

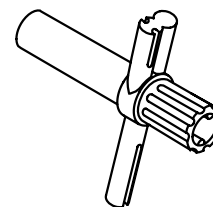

**M504-413**

# Latches and Deadbolts

H-Series latches and deadbolts can be ordered in combinations, separately or with locks. When ordering separately, specify quantity, product number, and finish. Standard deadbolt/latchbolt combinations, per backset, are shown in bold type.

**Square Corner**

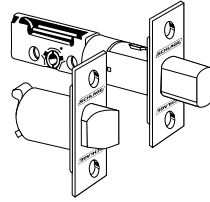

**Round Corner**

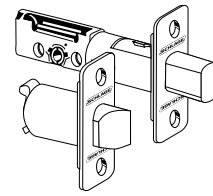

**Circular Drive-in**

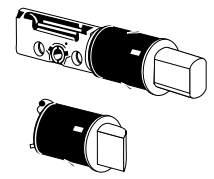

## Deadbolt/Springlatch Combinations for Single Locking Functions (H110)

Backset	Description	Hsg Dia	Latch	B500 Latches	Specify Combo Number
2 <sup>3</sup> / <sub>8</sub> " (60 mm)	<b>1" x 2<sup>1</sup>/<sub>4</sub>" (25 mm x 57 mm), square corner, standard</b>	<b>7/8"</b> <b>(22 mm)</b>	<b>11-068</b>	<b>12-237</b>	<b>19-055</b>
	1 <sup>1</sup> / <sub>8</sub> " x 2 <sup>1</sup> / <sub>4</sub> " (29 mm x 57 mm), square corner	1" (25 mm)	11-068	12-240	19-063*
	1" x 2 <sup>1</sup> / <sub>4</sub> " (25 mm x 57 mm), 1/4" (6 mm) radius round corner	7/8" (22 mm)	11-069	12-238	19-067
	Circular, drive-in, 626 only for bolt, 605 and 626 only for latch	1" (25 mm)	11-110	12-239	19-056
2 <sup>3</sup> / <sub>4</sub> " (70 mm)	1" x 2 <sup>1</sup> / <sub>4</sub> " (25 mm x 57 mm), square corner	7/8" (22 mm)	11-111	12-237	19-059
	1 <sup>1</sup> / <sub>8</sub> " x 2 <sup>1</sup> / <sub>4</sub> " (29 mm x 57 mm), square corner	1" (25 mm)	11-111	12-240	19-065*
	1" x 2 <sup>1</sup> / <sub>4</sub> " (25 mm x 57 mm), 1/4" (6mm) radius round corner	7/8" (22 mm)	11-112	12-238	19-068
	Circular, drive-in, 626 only for bolt, 605 and 626 only for latch	1" (25 mm)	11-113	12-239	19-060
5" (127mm)	1" x 2 <sup>1</sup> / <sub>4</sub> " (25 mm x 57 mm), square corner	7/8" (22 mm)	11-068	12-224	12-043**

## Deadbolt/Deadlatch Combinations for Double Locking Functions (H153, H180, H185)

Backset	Description	Hsg Dia	Latch	B500 Latches	Specify Combo Number
2 <sup>3</sup> / <sub>8</sub> " (60 mm)	<b>1" x 2<sup>1</sup>/<sub>4</sub>" (25 mm x 57 mm), square corner, standard</b>	<b>7/8"</b> <b>(22 mm)</b>	<b>11-085</b>	<b>12-237</b>	<b>19-057</b>
	1 <sup>1</sup> / <sub>8</sub> " x 2 <sup>1</sup> / <sub>4</sub> " (29 mm x 57 mm), square corner	1" (25 mm)	11-085	12-240	19-064*
	1" x 2 <sup>1</sup> / <sub>4</sub> " (25 mm x 57 mm), 1/4" (6 mm) radius round corner	7/8" (22 mm)	11-088	12-238	19-069
	Circular, drive-in, 626 only for bolt, 605 and 626 only for latch	1" (25 mm)	11-104	12-239	19-058
2 <sup>3</sup> / <sub>4</sub> " (70 mm)	1" x 2 <sup>1</sup> / <sub>4</sub> " (25 mm x 57 mm), square corner	7/8" (22 mm)	11-091	12-237	19-061
	1 <sup>1</sup> / <sub>8</sub> " x 2 <sup>1</sup> / <sub>4</sub> " (29 mm x 57 mm), square corner	1" (25 mm)	11-091	12-240	19-066*
	1" x 2 <sup>1</sup> / <sub>4</sub> " (25 mm x 57 mm), 1/4" (6mm) radius round corner	7/8" (22 mm)	11-092	12-238	19-070
	Circular, drive-in, 626 only for bolt, 605 and 626 only for latch	1" (25 mm)	11-105	12-239	19-062
5" (127mm)	1" x 2 <sup>1</sup> / <sub>4</sub> " (25 mm x 57 mm), square corner	7/8" (22 mm)	11-085	12-244	19-045**

\* Includes A501-878 latch front adapter and G506-815 housing sleeve for latch and bolt.

\*\* Includes A501-878 latch front adapter and G506-815 housing sleeve for latch and bolt with 41-005 backset extension link for latch.

**Latch Front Adapter**  
A501-878

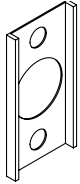

Used to convert 1" (25 mm) wide square front faceplates for 1 1/8" (29 mm) wide door preparations. Furnished in black plastic. Order in multiples of 100.

**Sleeve**  
G506-815



Used on 7/8" (22 mm) diameter latch housings in 1" (25 mm) edge bore. Furnished standard with complete locks.

**Door Reinforcement**

Schlage reinforcing units help prevent the collapse of hollow metal doors when locksets are tightly mounted.



**A501-565**  
1 3/8" (35 mm) Doors  
or  
**A501-566**  
1 1/4" (44 mm) Doors

# Strikes

**Deadbolt Strikes**

Part Number	Lip Length	Description
10-055	--	1 1/8" x 2 3/4" (29mm x 70mm) square corner, box, standard
10-064	--	1 3/16" (30mm) diameter, circular drive-in, thimble strike, 494 (for 626) only
10-092	1 1/8"	1 5/8" x 2 1/4" (41mm x 57mm) 1/4" (6mm) radius round corner, full lip, no box
10-095	(29mm)	1 5/8" x 2 1/4" (41mm x 57mm) square corner, full lip, no box

10-055

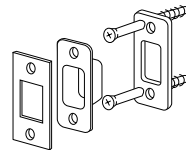

10-064



10-092

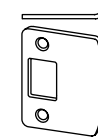

10-095

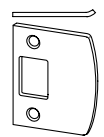

**Deadlatch Strikes**

Part Number	Lip Length	Description
10-001	1 1/8"	1 1/8" x 2 3/4" (29mm x 70mm) square corner, T-strike, box, standard
10-004	(29mm)	1 1/8" x 2 3/4" (29mm x 70mm) 1/4" (6mm), radius round corner, T-Strike, box
10-026		1 5/8" x 2 1/4" (41mm x 57mm) square corner, full lip, no box
10-027	1 7/32"	1 5/8" x 2 1/4" (41mm x 57mm) 1/4" (6mm) radius round corner, full lip, no box
10-058	(31mm)	1 3/4" (44mm) diameter, circular, adjustable, 605 and 626 only

10-001

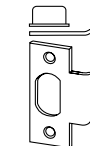

10-026

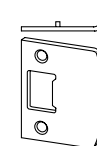

10-027

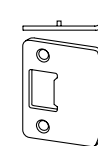

10-058

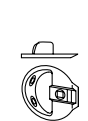

**Deadbolt/Deadlatch Strikes Combinations**

Combo Number	Deadbolt Strike	Deadlatch Strike
10-250	10-055	10-001, 1 1/8" (29mm) Lip
10-251	10-064	10-001, 1 1/8" (29mm) Lip
10-252	10-055	10-026
10-253	10-064	10-026
10-255	10-055	10-027
10-256	10-064	10-027
10-257	10-092	10-027
10-258	10-064	10-058
10-259	10-095	10-026

## Specifications

### Handing:

Field reversible.

### Door Thickness:

1<sup>3</sup>/<sub>8</sub>" to 1<sup>3</sup>/<sub>4</sub>" (35 mm - 44 mm).

### Backset:

2<sup>3</sup>/<sub>8</sub>" (60 mm) standard, 2<sup>3</sup>/<sub>4</sub>" (70 mm) and 5" (127 mm) optional.

### Fronts:

Brass or bronze. 1<sup>1</sup>/<sub>8</sub>" x 2<sup>1</sup>/<sub>4</sub>" (29 mm x 57 mm) square corner, beveled, for 2<sup>3</sup>/<sub>4</sub>" (70mm) backset standard. For availability with specific backsets, see page 18.

### Lock Chassis:

Steel, zinc dichromate plated for corrosion resistance.

### Deadbolt:

1" (25 mm) throw with hardened steel roller, and 1" (25 mm) housings standard.

### Latch Bolt:

Brass, chrome plated, 1/2" (13 mm) throw, deadlocking.

### Exposed Trim:

Knobs, roses, escutcheons, latch faceplates and strikes are wrought brass or bronze. Levers are zinc base, plated to match finish symbols.

### Strike:

T-strike 1<sup>1</sup>/<sub>8</sub>" x 2<sup>3</sup>/<sub>4</sub>" x 1<sup>1</sup>/<sub>8</sub>" (29 mm x 70 mm x 29 mm) lip to center with box standard. Optional strikes, lip lengths and ANSI strike box available. See page 19.

### Cylinder & Keys:

Commercial: 6-pin patented Everest C123 keyway standard with two nickel silver keys per lock.

Residential: 6-pin C keyway, keyed 5-pin.

### Keying Options:

Interchangeable core and Primus® high security cylinders. Master keying, grand master keying, and construction keying.

### Warranty:

Commercial: Three-year limited.

Residential: Full mechanical lifetime.

## Certifications

### Federal:

Meets FF-H-106C.

### UL / cUL:

All locks listed for A label single doors, 4' x 8'.

Letter F and UL symbol on latch front indicate listing.

### UL437 Listed locking cylinder optional:

Specify Primus 20-500 Series cylinder.

### ADA Compliant:

Schlage Lock Company offers a wide selection of locks designed to meet the Americans With Disabilities Act.

## Door Preparation

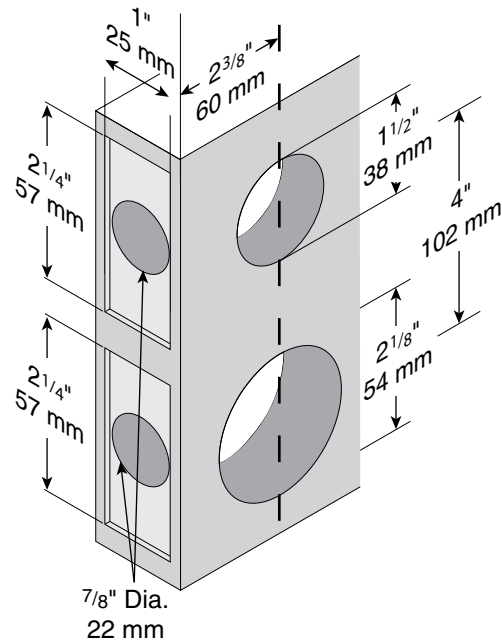

H-Series locks can be ordered for 2<sup>1</sup>/<sub>8</sub>" (54mm) top crossbore. Suffix "H" to the catalog number. Example: H110H

# Ordering Guidelines

To order Schlage products, descriptive data should be in the same sequence as shown.

Line Item	Qty	Products	Prep	Outside		Inside		Hand	Latch	Strike	Dim	Additional Details
				Des	Fin	Des	Fin					
1	2	3	4	5	6	7	8	9	10	11	12	13

- 1 Line item number
- 2 Quantity
- 3 Complete model number with function and cylinder type

To order cylinder options, add suffix to the model number as follows:



- H153 5-pin upper cylinder (standard for Residential)
- H153**6** 6-pin upper cylinder (standard for Commercial)
- H153**L** Less standard cylinder(s). For Primus cylinder, specify this option and order Primus cylinder(s) separately.
- H153**J** Prepared for full size interchangeable core, less core. For Primus cylinder, specify this option and order Primus cylinder(s) separately.



- H153**R** With full size conventional interchangeable core installed. Order control keys separately.
- H153**T** With full size (temporary) construction core installed. Order all keys separately.
- H153**J1** Knob prepared for full size IC, less core; standard cylinder for deadlock.
- H153**J2** Deadlock prepared for full size IC, less core; standard cylinder for knob.
- H153**R1** Full size IC installed in knob; standard cylinder for deadlock. Order control keys separately.
- H153**R2** Full size IC installed in deadlock; standard cylinder for knob. Order control keys separately.

- 4 Leave blank for 1½" (38mm) diameter top cross-bore. Specify "H" for 2¼" (54mm) diameter top cross-bore.
- 5/6 Outside design / finish.
- 7/8 Inside design / finish. Leave blank if same as outside.
- 9 Hand
- 10 Latch. Leave blank for standard or specify part number for optional latch. LLL = Less Latch.
- 11 Strike. Leave blank for standard or specify part number for optional strike. LLL = Less Strike.
- 12 Dimension for strike lip lengths. See price book for availability of specific dimensions with specific strikes.
- 13 Keying detail (e.g. key symbol, keyway, biting) and other special requirements.

## Example

Line Item	Qty	Products	Prep	Outside		Inside		Hand	Latch	Strike	Dim	Additional Details
				Des	Fin	Des	Fin					
1	100	H110L		ORB	605			RH				
2	100	20-724			606							1AA-100AA
3	50	H153	H	PLY	626	LEV	626					KA E00000

**Note:** Schlage order forms are available at no charge by contacting your sales representative or by visiting [schlage.com](http://schlage.com).

**SCHLAGE**







Ingersoll Rand's Security Technologies Sector is a leading global provider of products and services that make environments safe, secure and productive. The Sector's market-leading products include electronic and biometric access control systems; time and attendance and personnel scheduling systems; mechanical locks and portable security, door closers and exit devices, steel doors and frames, architectural hardware and technologies and services for global security markets.

[www.ingersollrand.com](http://www.ingersollrand.com)