

STERLING®

A KOHLER COMPANY

PERFORMA™

Features

- Compression molded from our exclusive solid Vikrell® material
- Durable high-gloss finish
- Shipped with a bath liner to protect product during installation
- Tongue-and-groove 4-piece modular design allows for easy "snap together" installation
- 10-year consumer/3-year commercial limited warranty
- 15" (38.1 cm) bath depth (floor to top of threshold)
- 60-1/4" (153 cm) x 30" (76.2 cm) x 76-1/2" (194.3 cm) complete unit rough-in dimensions includes flanges
- 60" (152.4 cm) x 29" (73.7 cm) x 75-1/2" (191.8 cm) complete unit finished dimensions

60" (152.4 cm) BATH AND WALL SURROUND 71040110

ALSO 71040120, 71040510, 71040520

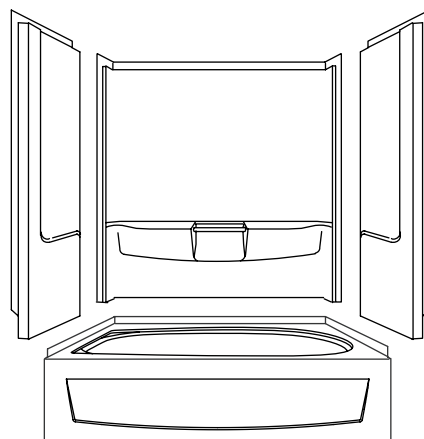

Codes/Standards Applicable

Specified model meets or exceeds the following:

- ANSI Z124.1.2
- HUD, UM Bulletin 73A
- NAHB Research Foundation, Inc.
- CSA B45
- ASTM E162
- ASTM E662

Colors/Finishes

- 0: White
- Other: Refer to Price Book for additional colors/finishes

Specified Model

Model	Complete Unit Description	Colors/Finishes	
71040110	60" (152.4 cm) bath and wall surround, left drain	<input type="checkbox"/> 0	<input type="checkbox"/> Other _____
71040120	60" (152.4 cm) bath and wall surround, right drain	<input type="checkbox"/> 0	<input type="checkbox"/> Other _____
71040510	60" (152.4 cm) bath and wall surround, 5 pack, left drain	<input type="checkbox"/> 0	<input type="checkbox"/> Other _____
71040520	60" (152.4 cm) bath and wall surround, 5 pack, right drain	<input type="checkbox"/> 0	<input type="checkbox"/> Other _____

Model	Wall Component Description	Colors/Finishes	
71042100	Back wall	<input type="checkbox"/> 0	<input type="checkbox"/> Other _____
71043110	Left end wall	<input type="checkbox"/> 0	<input type="checkbox"/> Other _____
71043120	Right end wall	<input type="checkbox"/> 0	<input type="checkbox"/> Other _____
71044100	Complete wall set	<input type="checkbox"/> 0	<input type="checkbox"/> Other _____
71045100	End wall set	<input type="checkbox"/> 0	<input type="checkbox"/> Other _____

Model	Age in Place Component Description	Colors/Finishes	
71040116	Complete unit with age in place backers, left drain	<input type="checkbox"/> 0	<input type="checkbox"/> Other _____
71040126	Complete unit with age in place backers, right drain	<input type="checkbox"/> 0	<input type="checkbox"/> Other _____
71041110	Bath only, left drain	<input type="checkbox"/> 0	<input type="checkbox"/> Other _____
71041120	Bath only, right drain	<input type="checkbox"/> 0	<input type="checkbox"/> Other _____

PERFORMA™

Technical Information

Fixture*:	
Basin area:	
Bathing well	21" (53.3 cm) x 39" (99.1 cm)
Top area	24" (61 cm) x 53" (134.6 cm)
To overflow:	
Water depth	10-1/4" (26 cm)
Capacity	35 gal (132.5 L)
* Approximate measurements for comparison only.	

Model	door maximum width	door maximum height
71040110	56-3/4" (144.1 cm)	59-1/2" (151.1 cm)
71040120	56-3/4" (144.1 cm)	59-1/2" (151.1 cm)

Installation Notes

Install this product according to the installation guide.

Size the drain cutout to fit the drain assembly that will be used.

Double studding is recommended to pivot shower door installations.

Studs should be positioned roughly as shown.

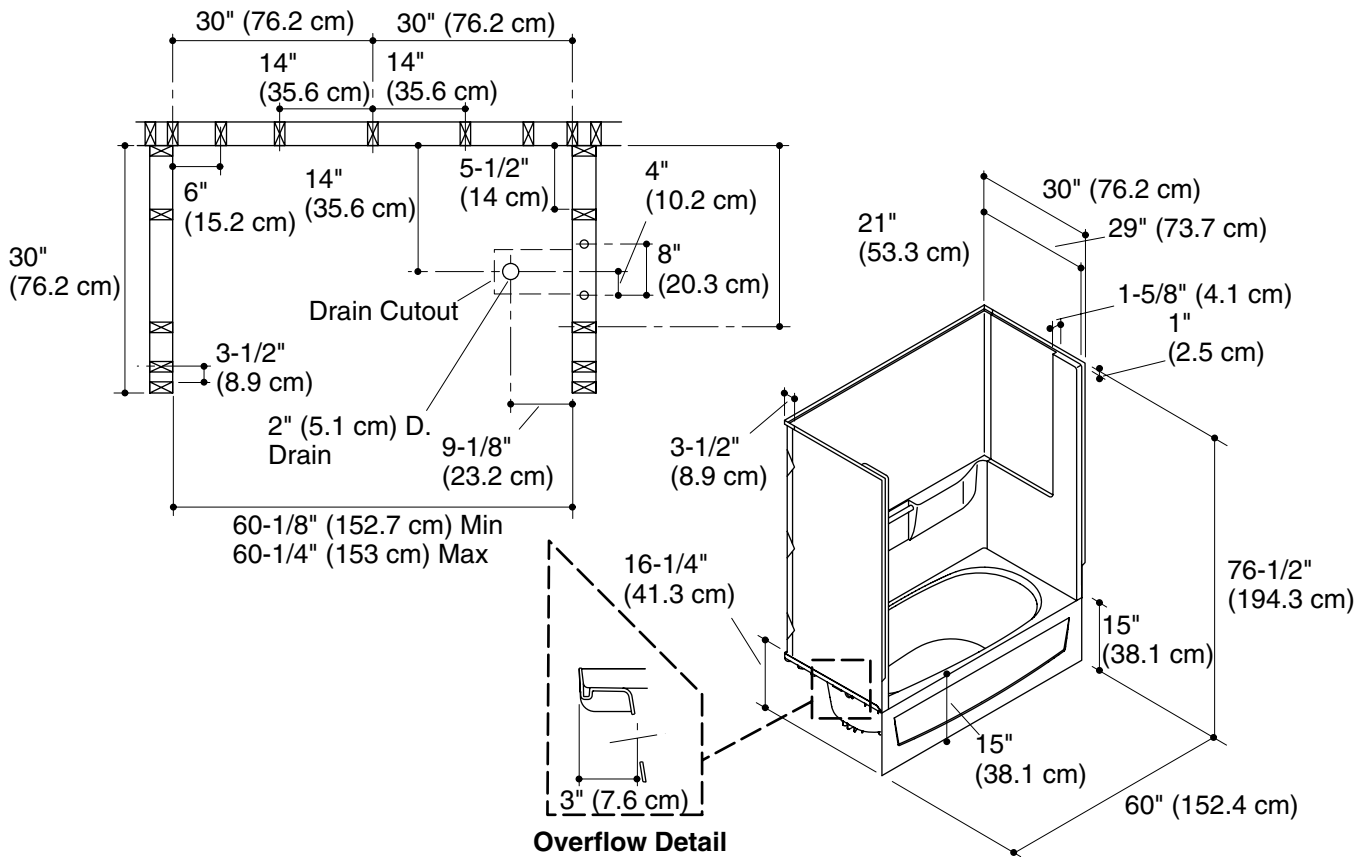

Product Diagram