

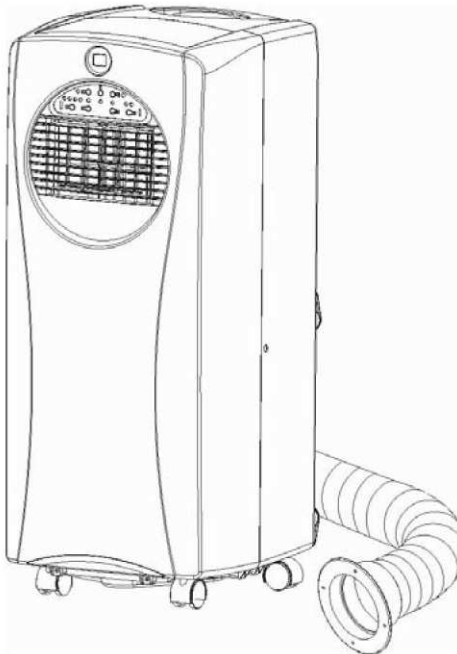

PORTABLE AIR CONDITIONER WITH HEATER



WA-9061H: 9,000 BTU

WA-1061H: 10,000BTU

☆ Read and retain these instructions for future reference

SPECIFICATION

Model no.	WA-9061H	WA-1061H
Cooling capacity	9000 BTU/hr 2637 W	10000 BTU/hr 2930 W
Heating capacity	8500 BTU/hr 2491 watts	9500 BTU/hr 2783 watts
EER	9.38	9.35
Power/Ampere consumption – Cooling*	960W / 8.29 A	1070W / 8.7 A
Power/Ampere consumption – Heating*	840W / 7.75 A	950W / 8.18 A
Air volume (max. speed)	375m ³ /h	375m ³ /h
Humidity removal capacity	1 L/hr	1 L/hr
Power supply	110~120V/50Hz/1phase	
Compressor	rotary	
Recommended room size	250 sq.ft.	300 sq.ft.
Refrigerant	R410A	
Fan speed	2	
Timer	1~ 12 hours	
Thermostat	Cooling: 64~90°F (18~32°C) Heating: 45~77°F (7~25°C)	
Operating temperature	45 ~ 95°F	
Exhaust pipe	5 x 59 in	
Net Weight	47.4 lbs	55.12 lbs
Dimension	12W x 15D x 29.61H in	

* Data may vary for technical reasons; for greater precision, please refer to the rating label located on the back of the unit.

NOTE:

- Measuring condition for above is:
Cooling: DB= 95°F / WB= 75°F
Heating: DB= 68°F / WB = 59°F
- Current & Fuse: F2L250V or T2L250V

BEFORE USE

GENERAL SAFETY

- Only use in the upright position on a flat level surface and at least 14in. from any walls or objects (fig 1 & 4).
- Do not place any objects on the unit or block the air inlet / outlet (fig. 2).
- Closely supervise children and pets when unit is in use.



FIG. 1

ELECTRICAL SAFETY

- For indoor household use only.
- Switch off and unplug when not in use.
- Do not use in humid or wet environments. (fig 3)
- Do not pull the UNIT by the cord.
- IF THE SUPPLY CORD IS DAMAGED, TO AVOID HAZARD, IT MUST BE REPLACED BY AN ELECTRICIAN OR SIMILARLY QUALIFIED PERSON.

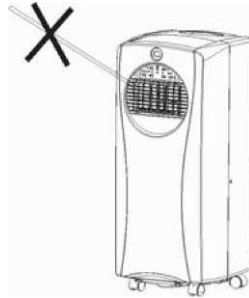

FIG.2

FOR MAXIMUM EFFICIENCY

- Use the unit in the recommended room size.
- Locate the unit where furniture cannot obstruct the airflow.
- Close doors and windows.
- Keep curtains or blinds closed during the sunniest part of the day.
- Keep filters clean.
- Set unit to maximum cooling on high initially and once room has reached the desired conditions, reduce temperature and fan speed settings.
- It is recommended to turn on the air conditioner when ambient temperature reaches 75F. Do not wait until the room is excessively hot.

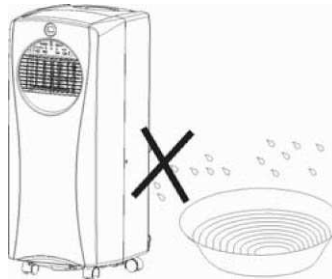

FIG.3

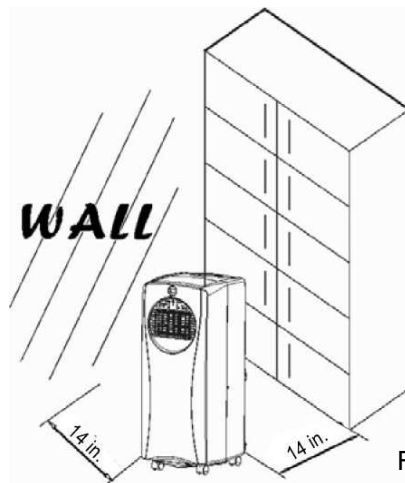

FIG.4

PARTS

Front

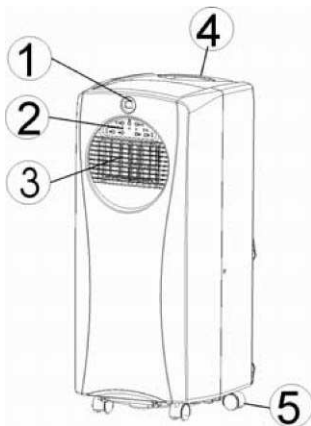

FIG.5

- 1. Display window
- 2. Control panel
- 3. Air outlet
- 4. Carrying handle
- 5. Caster

Back

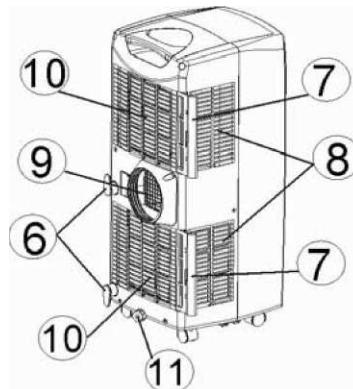

FIG.6

- 6. Cord storage
- 7. Air filter
- 8. Air inlet
- 9. Exhaust air outlet
- 10. Air inlet
- 11. Water stopper/drainage

Accessories

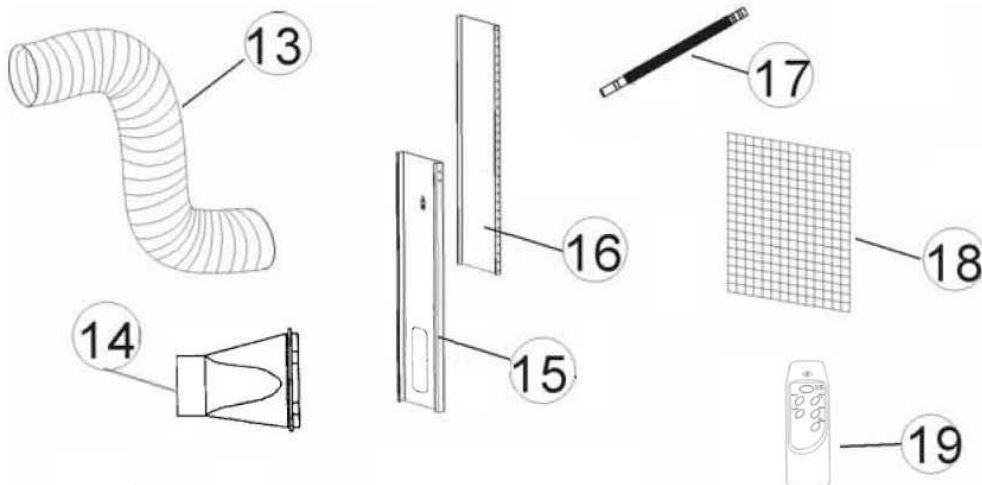

FIG.7

- 13. Exhaust hose
- 14. Slider kit adapter – connects exhaust hose to slider kit.
- 15. Plastic slider kit – piece 1 of 2
- 16. Plastic slider kit – piece 2 of 2
- 17. Drain tube
- 18. Active carbon filter
- 19. Remote

INSTALLATION

The unit is a portable air conditioner that may be moved from room to room.

1. Installing the plastic slider kit.

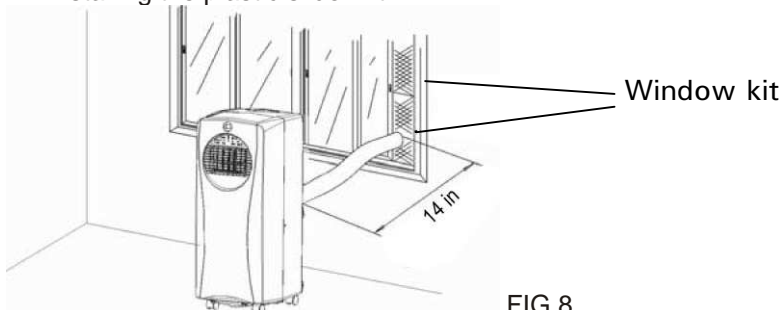

FIG.8

- Extend both ends of the exhaust hose by few inches.
- Connect hose to the back of unit by turning clockwise – do not over tighten.
- Connect adapter piece to hose by turning clockwise (with opening end facing you).
- Determine how many sections of the slider kit your window requires.
- Place slider kit inside the window frame and adjust height accordingly. Once set, insert the small screw through side opening to secure.
- Align and insert adapter piece to opening on window kit.
- Slide window close against the window kit.
- The best distance between the machine and window or wall is 31-39 inches.

Mounting of the exhaust pipe

- Use only the hose provided and clip exhaust hose to the back of the air conditioner
- Avoid kinks and bends in the exhaust hose. If expelled air is not exhausted smoothly, it will build up in the hose and lead to unit overheating and shutting down. Refer to Fig 11 & 12 for correct position.
- The hose may be extended from 11" to 59". But for maximum efficiency, use the shortest length possible.

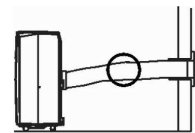

FIG.11

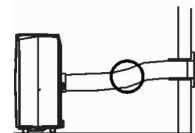

FIG.12

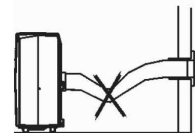

FIG.13

WARNING!

The length of the exhaust pipe is specially designed according to the specification of this product. Do not replace or prolong it with your own private hose as this could cause the unit to malfunction.

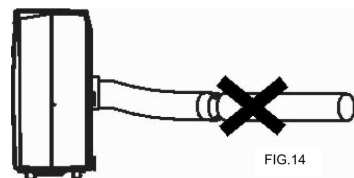
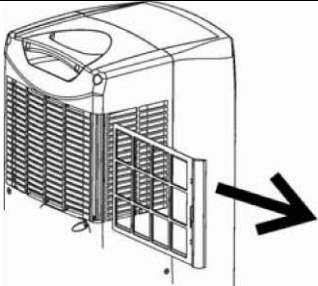
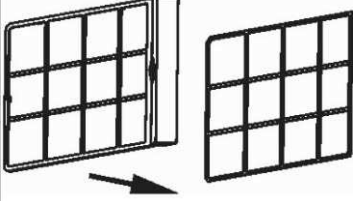
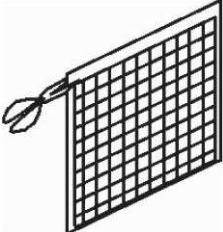
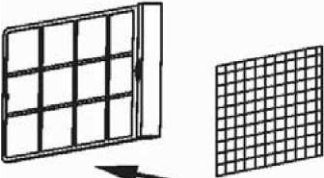
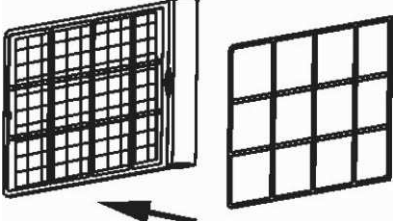
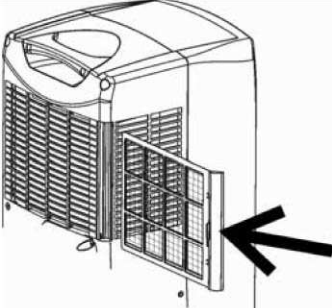

FIG.14

Carbon Filter Installation

	<p>1. Remove filter frame from unit.</p>
	<p>2. Remove the filter fixer from the filter frame.</p>
	<p>3. Remove active carbon filter from plastic bag.</p>
	<p>4. Insert active carbon filter to filter frame.</p>
	<p>5. Replace filter fixer to frame. The active carbon filter is now held in between the filter frame and filter fixer.</p>
	<p>6. Replace filter frame to unit.</p>

OPERATION

Control panel

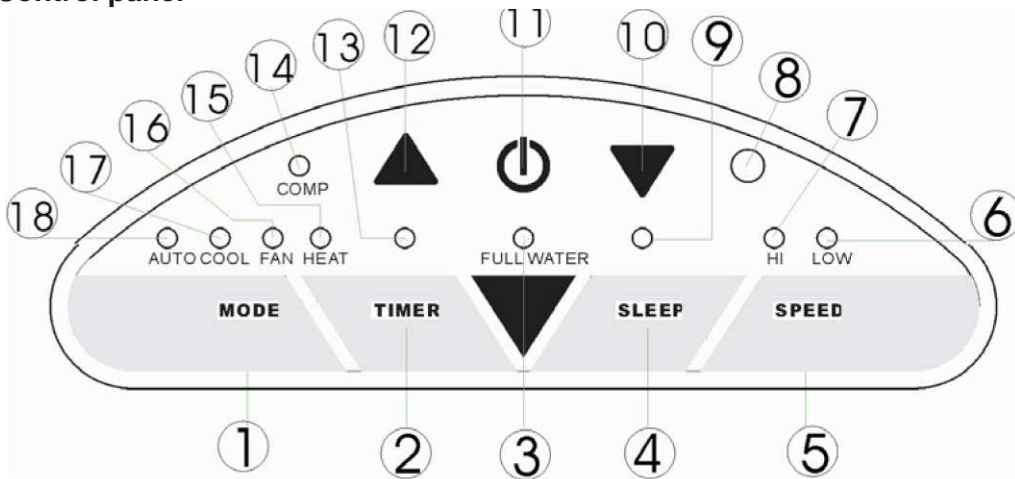

FIG.15

1. Mode (function) select button
2. Timer button
3. "Water Full" indicator
4. Sleep button
5. Fan speed button
6. Low fan speed indicator
7. High fan speed indicator
8. Receiver for remote control
9. Sleep operation indicator
10. "Temperature down" button
11. ON/OFF (power) button
12. "Temperature up" button
13. Timer operation indicator
14. Compressor operation indicator
15. Heat mode indicator
16. Fan mode indicator
17. Cooling mode indicator
18. Auto mode indicator

Turning ON/OFF

1. Press ON/OFF button and unit will start automatically. If ambient temperature is:
 - Above 74°F/23°C, the unit will work in Cool mode.
 - Above 68°F/20°C but below or equal to 74°F/23°C, the unit will work in Fan mode.
 - Below 68°F/20°C, the unit will work in Heat mode.
2. Indicators of the functions in progress will illuminate.
NOTE: The display window shows ambient room temperature from 32~122°F/0~50 °C.
3. To turn the unit off, press ON/OFF button again.

Setting mode/function

Press MODE button to select desired working mode: AUTO, COOL, FAN or HEAT.
The indicator of selected mode will illuminate.

Setting temperature

1. Press 'Temperature up' or 'Temperature down' button to set desired temperature.
2. The display window will show the set temperature as the UP or DOWN buttons are pressed.
Once the buttons are release, display will revert to show the ambient temperature.
3. The pre-set temperature is 75°F/24°C for cooling and 68°F/20°C for heating.

Setting fan speed

1. Press SPEED button to choose the desired fan speed, high or low. The corresponding indicator (HI or LOW) will illuminate.
2. If the unit is operating in AUTO mode, the SPEED button is invalid. Unit will automatically choose the fan speed based on the ambient temperature.

Setting timer

1. If unit is in operation, pressing the TIMER button will set the operating hours (from 1 to 12 hours). Once the set time has been reached, unit will turn off automatically. Timer indicator will illuminate. Display window shows the hour(s) as TIMER button is pressed.
2. If unit is off, pressing the TIMER button will pre-set the time for the unit to come on. For example, if you set the timer to 2, the unit will begin operating after 2 hours.

Sleep function

1. When selected in COOL mode: unit will increase the set temperature by 2°F /1°C after the first hour and another 2°F /1°C after the second hour, then keeps at that temperature.
2. When selected in HEAT mode: unit will decrease the set temperature by 2°F /1°C after the first hour and another 2°F /1°C after the second hour, then keeps at that temperature.
3. In SLEEP mode, fan speed will be kept at **LOW**.
4. Pressing the SLEEP button again will revert set temperature and fan speed back to pre-selected settings.
5. The unit will shut down automatically after operating in SLEEP mode for 12 hours continuously.

NOTE: SLEEP function is not available in AUTO or FAN mode.

HEAT mode

1. When HEAT mode is selected, the ambient warm air will be recycled and utilized to heat the area where it is required. **The Exhaust Pipe must be fitted properly to exhaust the cold air outdoors.**
2. Continuous drain is mandatory when unit operates in heat mode.
3. The working temperature range for heating function is 45~77°F/7~25°C. If ambient temperature is outside this range, the unit may not work properly.

Remote control

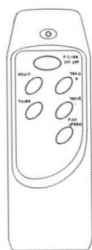

Fig.16

All functions can also be performed with the supplied remote control. The remote control requires two (2) AAA batteries.

Directing air flow

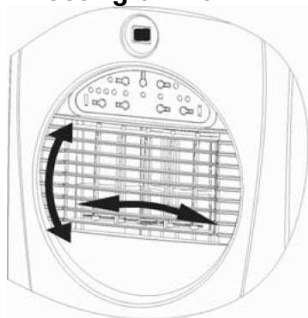

FIG. 17

Manually adjust the louvers left & right or up & down to direct air flow.

NOTICE !

- To prolong the life of the compressor, after powering off the unit, please wait at least 3 minutes before turning it back on.
- When operating in COOL mode, the cooling system will switch off when ambient temperature falls below set temperature. The fan, however, will continue to run. Once ambient temperature rises above the selected level, cooling will resume.
- When operating in HEAT mode, heating will switch off when ambient temperature is higher than set temperature. The fan, however, will continue to run. Once ambient temperature drops below the selected level, heating will resume.
- This machine is equipped with ANTI-FROST function. When unit is operating in low temperature surroundings, the heating function may be paused at times to defrost. When this occurs, just wait for heating to resume.

DRAINAGE

During the cooling process, some water will be extracted from the air into the unit. If the reservoir is full, both of the compressor (cooling) and motor (fan) will stop and unit will emit a Buzz (press any button to stop the buzz); the Water Full indicator will also be flashing.

Before cooling can resume, empty the water tank:

1. Turn off the air conditioner and avoid moving it when full.
2. Position a container (a water tray for example) underneath the drain spout.
3. Remove the drain knob & rubber plug and allow water to drain out.
4. When the container is almost full, replace the rubber plug and empty the water tray. Repeat until the unit is emptied.
5. Replace rubber plug and tighten drain knob firmly.
6. Switch on the unit – the Water Full indicator should no longer be flashing.

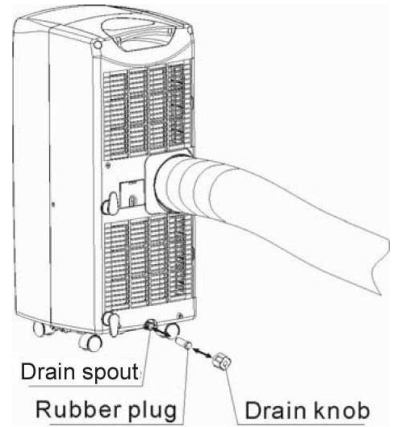

FIG.18

Continuous drainage (if you wish to operate the unit without the need to empty the water tank):

- Remove the drain knob and rubber plug and retain for future use.
- Connect the supplied drain tube to the drain spout as shown and locate the other end into a drain.
- Note the drainage is gravity-pulled, the drain tube must not have any incline.
- The drain tube can be extended by adding an extension tube with a suitable connector.

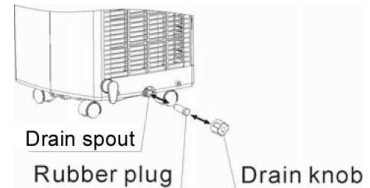

FIG.19

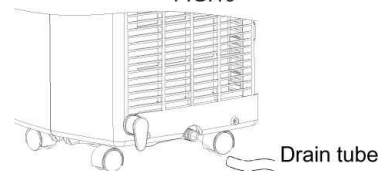

FIG.20

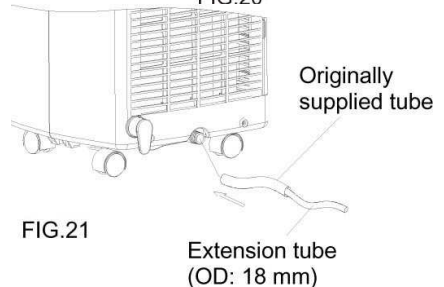

FIG.21

Note

- Drain tube must be paralleled or below outlet level.
- Flashing 'Water Full' indicator will not function in continuous drainage.
- To extend the water tube, connect with another tube (OD: 18mm)

MAINTENANCE

**Always unplug the air conditioner from power source before cleaning.
Clean regularly to maximize the efficiency of the air conditioner.**

Cleaning the housing

- Use a soft, damp cloth to wipe the body clean.
- Never use aggressive chemicals, gasoline, detergents, chemically treated cloths, or other cleansing solutions. These products may blemish the cabinet.

Cleaning the filter

- Use a vacuum cleaner or tap the filter lightly to first remove any loose particles, then rinse thoroughly under running water (no hotter than 104°F/40°C).
- Dry thoroughly before replacing.
- **Never operate the unit without the filters.**

End of season storage

- Drain water from the unit.
- Operate the unit in FAN mode for a few hours to thoroughly dry the inside.
- Clean or change the filters.
- Unplug and store the power cord as shown.
- Replace in the original carton or cover for storage.

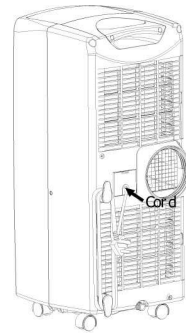

FIG 22

TROUBLE SHOOTING

The air conditioner does not run	<ul style="list-style-type: none"> ▪ Is the air conditioner plugged in? ▪ Is there a power failure? ▪ Is the Water Full indicator flashing? ▪ Is the room temperature below the set temperature?
The machine seems to do little	<ul style="list-style-type: none"> ▪ Is there direct sunshine? (Please close curtain) ▪ Too many windows or doors open? ▪ Too many people in the room? ▪ Is there something in the room producing lots of heat?
The machine seems to do nothing.	<ul style="list-style-type: none"> ▪ Is the filter dusty, contaminated? ▪ Is the air intake or output blocked up? ▪ Is the room temperature below set temperature?
Too noisy	<ul style="list-style-type: none"> ▪ Is the machine positioned unevenly, creating vibration? ▪ Is the floor underneath the machine uneven?
The compressor doesn't run.	<ul style="list-style-type: none"> ▪ It is possible the overheat protection is on. Just wait for the temperature to drop.

☆ Never try to repair or dismantle the unit yourself



Your Guarantee

If this product is found to be faulty as a result of faulty materials or workmanship within one year from date of purchase, it will be repaired free of charge.

This guarantee is subject to the following terms:

- Sunpentown must be notified of the fault.
- Proof of purchase must be presented to Sunpentown's nominated representative.
- The warranty will be void if the product is modified, misused or repaired by an unauthorized person.
- The warranty after repair will not be extended beyond the original one-year period.
- All replacement parts will be new or reconditioned.
- Parts, which are replaced, become the property of Sunpentown.
- The warranty applies for the use of the product in the USA only.

What is NOT COVERED:

- Warranty does not include freight charges.
- Incidental or consequential damage caused by possible defects with this product.
- Damage to product caused by improper power supply voltage, accident, fire, floods or acts of nature.
- Failure of product resulting from unauthorized modifications to the product.
- Improper installation or failure to perform the necessary maintenance.

This GUARANTEE is in addition to your Statutory Rights

SUNPENTOWN INTERNATIONAL INC.
14625 Clark Ave. City of Industry, CA 91745
Tel: 800-330-0388
service@sunpentown.com
www.sunpentown.com