

# Vent-A-Hood® RETRO STYLE WALL MOUNT RANGE HOOD SPECIFICATIONS

**AH12** Halogen lights only. This model is not available with heat lamps. Painted round duct and ceiling collar are priced separately.

Includes side wing panels and splash panel. Splash panel is 30" tall x hood width.

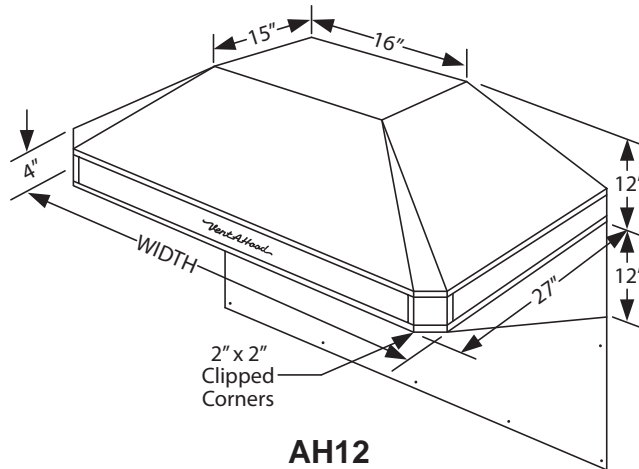

## Connection Diagram (30" - 48" Widths)

30" Model is Limited to B100 Single Blower Only

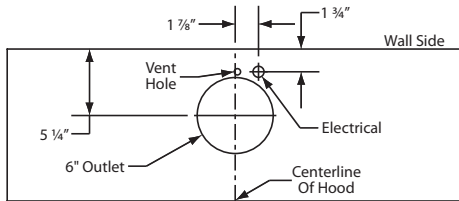

**300 CFM B100 Single Blower (Top View)**

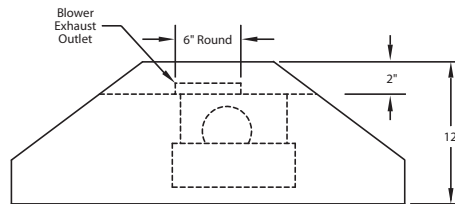

**(Front View)**

## Connection Diagram (36" - 48" Widths)

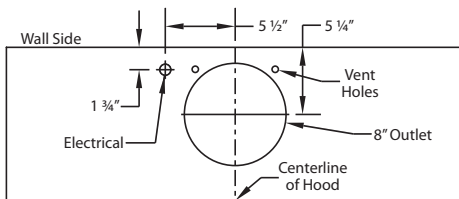

**600 CFM B200 Dual Blower (Top View)**

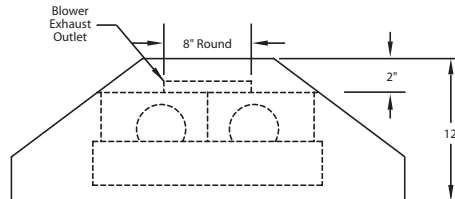

**(Front View)**

## Recommended Mounting Height\*

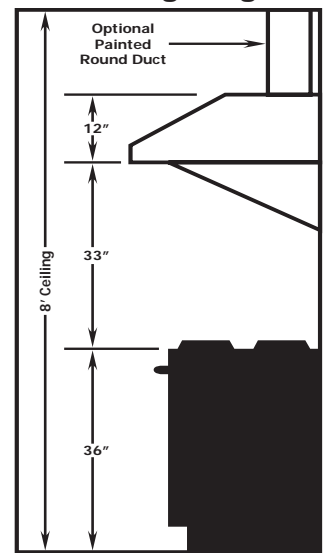

\*Exceeding recommended mounting height may compromise performance.

NOTE: DUCT PIPE EXTENDS 2" INTO TOP OF HOOD AND 1" INTO CEILING.

## Optional Painted Round Duct

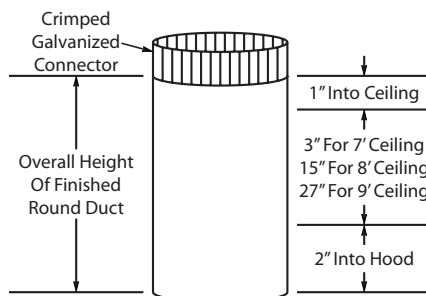

## Optional Ceiling Collars

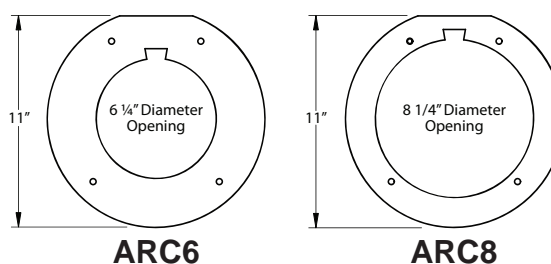

## Electrical/Mechanical Specifications For Blower Units

Model	Volts	Amps*	Hz	RPM	CFM SP@0.0"	Equivalent CFM*	CFM SP@0.1"	CFM SP@0.2"	CFM SP@0.3"	Minimum Round Duct Size	Sones#
B100 Single	115	1.5	60	1550	300	450	273	245	225	6" (28 in. <sup>2</sup> )	5.4
B200 Dual	115	2.9	60	1550	600	900	531	480	430	8" (50 in. <sup>2</sup> )	6.5

\* Add 0.5 amp for each halogen light. Hood is available with halogen lights (2 lights: 30" - 41"; 3 lights: 42" - 48").

# Because the Magic Lung® blower uses centrifugal filtration rather than conventional baffle or mesh filters, the Magic Lung® blower can handle cooking equipment with higher cubic feet per minute (CFM) requirements and can deliver equivalent CFM much more efficiently than other than other filtration systems. When comparing the Magic Lung® with other blower units made by other manufacturers, use the "Equivalent CFM".

# Ratings in accordance with the Standard Test Code by the Energy Systems Laboratory of the Texas Engineering Experiment Station.

