

Non-Programmable Thermostat with 3 Temperature Pre-Sets Home, Sleep and Away

Installation Instructions and User Guide

Message to Homeowner

Congratulations on choosing the Emerson Blue Easy Set Thermostat. The Easy Set is designed to be the easiest thermostat you have ever used. This thermostat features Home, Sleep, and Away temperature pre-sets. Just press the button and go. Included with the easy set is the same temperature accuracy and reliability you expect from all the Emerson Blue thermostats.

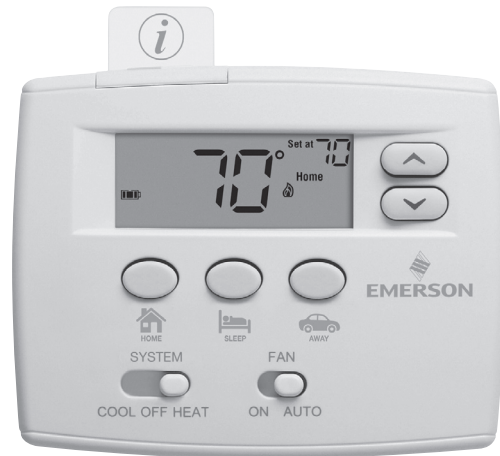

Just Press the Button and Go!

Table of Contents

Get to know your thermostat.....	2
Thermostat buttons and switches	2
Display	2
Batteries	2
Using your thermostat	3
Home, Sleep and Away temperature pre-sets	3
Sleep Timer option	3
Change Filter reminder option	3
Cool Savings option	3
Installation	4
Remove the old thermostat	4
Install the new thermostat	4
Set switches	4
Check thermostat operation	4
Select configuration options	5
Configuration menu	5
Troubleshooting Guide	6
Technical Data	7
Wiring diagrams	7
Thermostat application guide	8
Specifications	8

This thermostat is intended for use with a low voltage NEC Class II system. Do not use this thermostat with a line voltage system. If in doubt about whether your wiring is millivolt, line, or low voltage, have it inspected by a qualified heating and air conditioning contractor or electrician.

Do not exceed the specification ratings.

All wiring must conform to local and national electrical codes and ordinances.

This control is a precision instrument, and should be handled carefully. Rough handling or distorting components could cause the control to malfunction.

Get to know your thermostat

Before you begin using your thermostat, you should be familiar with its features and with the display and the location and operation of the thermostat buttons and switches.

The Thermostat Buttons and Switches

- ① Raises temperature setting.
- ② Lowers temperature setting.
- ③ Easy Temperature pre-sets (**Home, Sleep, Away**).
- ④ SYSTEM switch (**COOL, OFF, HEAT**).
- ⑤ FAN switch (**ON, AUTO**).

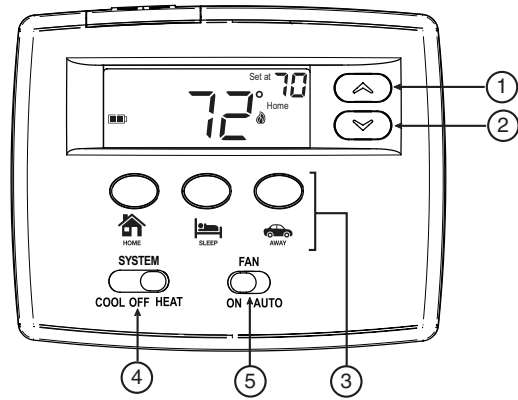

The Display

- ⑥ Indicates desired temperature. This is blank when system switch is in the OFF position. Desired temperature is displayed (flashing) if the thermostat is in lockout mode.
- ⑦ **“Save”** indicates the Cool Savings feature is enabled in the configuration menu. **“Save”** flashing indicates Cool Savings feature is operating and saving energy. **“Save”** will also flash for 3 seconds after changing the temperature to indicate that a pre-set can be saved.
- ⑧ Indicates system mode. **Heat icon** (Δ) is displayed when the SYSTEM switch is in the HEAT position. Heat icon (Δ) is displayed flashing when thermostat is calling for heat. Cool icon (❄) is displayed when the SYSTEM switch is in the COOL position. Cool icon (❄) is displayed (flashing) if the thermostat is calling for cool.
- ⑨ Displays current temperature.

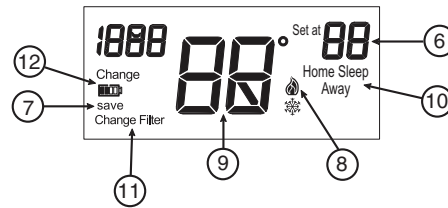

- ⑩ **“Home”, “Sleep”, “Away”** indicates the easy temperature pre-set is enabled.
- ⑪ **“Change Filter”** is displayed when the system has run for the programmed filter time period as a reminder to change or clean your air filter.
- ⑫ **“Change [Battery Icon]”** indicates power level of batteries. **“Change [Battery Icon]”** indicates batteries should be replaced.

Batteries

Two “AA” alkaline batteries are included with your thermostat. Prior to use, open the battery door and remove the battery tag. We recommend replacing batteries every 2 years, for best results, use new premium brand alkaline batteries such as Duracell® or Energizer®. When battery power remaining is approximately half, the [Battery Icon] will be displayed.

Change [Battery Icon] Indicates batteries are low and should be replaced

BATTERY LOCATION

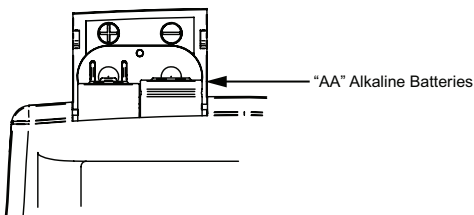

CAUTION

If the home is going to be unoccupied for an extended period (over 3 months) and [Battery Icon] is displayed, the batteries should be replaced before leaving. When less than two months of battery life remain, the setpoint temperature will change by 10 degrees (10 degrees cooler in Heat / 10 degrees warmer in Cool) to alert you to change the batteries before they fail. If the temperature change occurs, the normal setpoint can be manually reset. However, the temperature will change by 10 degrees within two days if the batteries are not replaced.

WARNING

Do not use on circuits exceeding specified voltage. Higher voltage will damage control and could cause shock or fire hazard.
Do not short out terminals on gas valve or primary control to test. Short or incorrect wiring will damage

thermostat and could cause personal injury and/or property damage.
Thermostat installation and all components of the system shall conform to Class II (current limited) circuits per the NEC code. Failure to do so could cause a fire hazard.



Using your thermostat

Home, Sleep and Away Temperature Pre-Sets



You can set your (Home, Sleep, Away) temperatures for use when you get home, go to sleep, or leave home. Then, just press the button you want and go.

Favorite Temperatures are set at the factory as indicated in the following table. You can use pre-sets or change to different temperature pre-sets.



Factory Pre-set Temperatures

	HEATING	COOLING
 HOME	70° F	75° F
 SLEEP	62° F	78° F
 AWAY	62° F	83° F



Your Pre-set Temperatures

	HEATING	COOLING
 HOME		
 SLEEP		
 AWAY		

Change Home, Sleep and Away Temperature Pre-sets

1. Move SYSTEM switch to **HEAT** position.
2. Using the  or  button, set the desired temperature.
3. Press and hold the **Home, Sleep, or Away** button for 3 seconds. The display will go blank (except for the battery icon and heat/cool icon) and back on again indicating that the thermostat has saved your pre-set.
4. Repeat the process for the remaining Pre-sets to be changed.
5. Move SYSTEM switch to **COOL** to Pre-set Temperatures for cooling.

Use Home, Sleep and Away Temperature Pre-Sets

1. Press the **Home, Sleep, or Away** button. The display will show the icon for the button pressed and display the temperature setting.
2. The thermostat will maintain the selected pre-set temperature until you change it by pressing the  or  button or selecting another Pre-set Temperature.



Sleep Timer Option

The sleep timer will automatically change the thermostat from the Sleep to Home temperature after the number of hours set in the configuration menu. The Sleep timer default is 8 hours and can be changed to a setting between 1 to 12 hours.

Example: You have selected 8 hours for the Sleep timer in the configuration menu. Press the Sleep button, the thermostat will maintain the sleep temperature for 8 hours. After 8 hours the thermostat will go back to the Home temperature. The Sleep timer will be activated each time the sleep button is pressed.

Change Filter Reminder Option

The thermostat can display a reminder when it is time to change the air filter on your heating and cooling system. The Change Filter will automatically display after the number of hours set in the configuration menu. The change filter reminder time default is 200 hours and can be changed to a setting of 25 to 1975 hours; 200 hours is approximately 3 months.

Example: You have selected 250 hours for the change filter reminder. The thermostat will display change filter after 250 it has counted down 250 hours. When **“Change Filter”** is displayed, press the  or  button to clear the display and restart the timer.

Cool Savings™ Option

With Cool Savings enabled, the thermostat will make small adjustments to the desired temperature during periods of high demand to reduce cooling system running time and save energy. When the cooling system has been running for more than 20 minutes, humidity in the home will be lower and a higher temperature will feel comfortable. After 20 minutes of run time, the thermostat will start increasing the desired temperature in steps of less than one degree as the system continues to run. These adjustments will eventually cause the system to satisfy the thermostat and turn the system off to reduce the energy consumption. When the Cool Savings feature is active and making adjustments, the display will flash “Save”. The amount of adjustments to the desired temperature is dependent on the Cool Savings value that is set, 1 being the least adjustment and 6 being the most adjustment. With this feature set to OFF, no change will occur when the cooling system is continuously running during the periods of high demand. Periods of high demand will normally occur during the late afternoon and early evening on the hottest days of the summer.

Installation

Remove the Old Thermostat

1. Turn off power to the heating and cooling system.
2. Remove the front cover of the old thermostat, this usually pulls off.
3. Loosen the screws that hold the thermostat to the wall.
4. Identify each wire attached to the old thermostat.
5. Disconnect the wires from old thermostat one at a time. **DO NOT LET WIRES FALL BACK INTO THE WALL.**

Install the New Thermostat

1. Open the battery door and detach the new thermostat cover from the base.
2. With the base flush against the wall, mark mounting hole locations on wall.
3. Move base out of the way and drill mounting holes.
4. Push wires through wire opening.
5. Position the base on the wall again and screw the mounting screws into the wall anchors.
6. Connect each wire coming from the wall to its corresponding terminal as shown in Fig. 2 thru 4 on page 7.

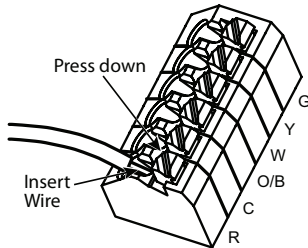

Wire Terminal Block

NOTE

Wires will not be connected to all terminals of the terminal block.

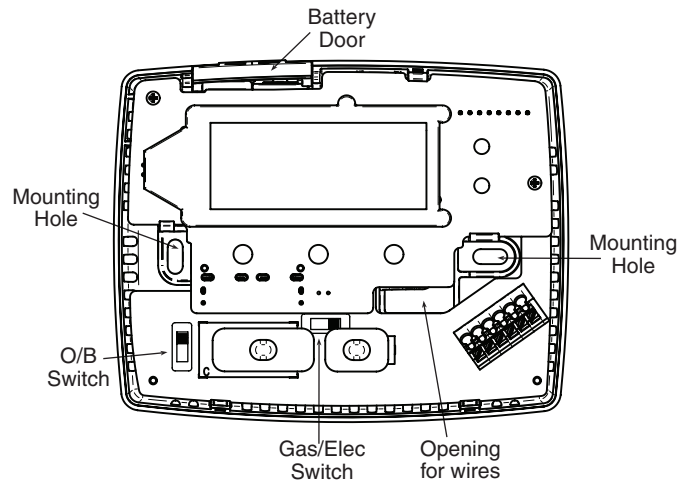

Figure 1. Thermostat Base

Set Switches

Gas / Elec Switch

If your system is a heat pump, the GAS/ELEC Switch must be set to ELEC (see Fig. 1) If your system is a single stage, the switch must be set to GAS. The switch setting must agree with the system configuration selected in the configuration menu.

O/B Terminal Switch Selection

The O/B switch on this thermostat is factory set to the “O” position. This will accommodate the majority of heat pump applications, which require the changeover relay to be energized in COOL. If the thermostat you are replacing or the heat pump being installed with this thermostat requires a “B” terminal, to energize the changeover relay in HEAT, the O/B switch must be moved to the “B” position.

Check Thermostat Operation

Heating System

1. Move SYSTEM switch to **HEAT** position. If the heating system has a standing pilot, be sure to light it.
2. Press to adjust thermostat setting to 1° above room temperature. The heating system should begin to operate.
3. Press to adjust temperature setting below room temperature. The heating system should stop operating.

Fan Operation

If your system **does not** have a **G** terminal connection, skip to **Heating System**.

1. Move SYSTEM switch to OFF position.

2. Move fan switch to **ON** position. The blower should begin to operate.
3. Move fan switch to **AUTO** position. The blower should stop immediately.

Cooling System



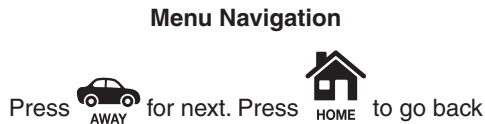
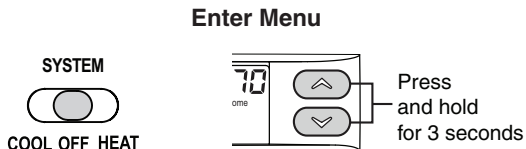

1. Move SYSTEM switch to **COOL** position.
2. Press to adjust thermostat setting below room temperature. The blower should come on immediately on high speed, followed by cold air circulation. However, if the setpoint temperature is flashing, the compressor lockout feature is operating (see Configuration menu, item 5).
3. Press to adjust temperature setting above room temperature. The cooling system should stop operating.

Select Configuration Options

The configuration menu allows you to set certain thermostat operating characteristics to your system or personal requirements.



Configuration Menu

Menu Screen Number	Displayed (Factory Default)	Press  or  to select options	
01	(SS)	HP	Select Single Stage (SS) or Heat Pump (HP) for a single compressor
02	Sleep (OFF)	On	Select Sleep Timer On or OFF If selected OFF, skip to menu screen 04
03	h (8)	1 to 12	Select 1 to 12 hours for Sleep Timer On. See Sleep Timer section on page 3
04	CS (OFF)	On	Select Cool Savings Feature On or OFF If selected OFF, skip to menu screen 06
05	CS (3)	1 to 6	Select 1 to 6 for Cool Savings Feature On See Cool Savings section on page 3
06	CR  (ME)	FA, SL	Select Adjustable Anticipation, cycle rate for Heat See table below
07	CR  (ME)	FA, SL	Select Adjustable Anticipation, cycle rate for Cool See table below
08	CL (OFF)	On	Select Compressor Lockout OFF or On. When selected On, the thermostat will wait 5 minutes before turning the compressor on.
09	L (On)	OFF	Select Display Light On or OFF. When selected On and the "C" terminal is connected, the backlight will stay on continuously. When OFF the backlight will come on for a short time when any key is pressed.
10	Room Temp (0)	4 LO to 4 HI	Select room temperature display for 4° higher or 4° lower than the actual temperature
11	°F	°C	Select °F or °C Display (temperature displayed in Fahrenheit or Celsius)
12	Change Filter (OFF)	On	Select filter maintenance indicator OFF or On. If selected OFF, item B will be skipped
13	Change Filter (200 h)	25 to 1975	Select 25 to 1975 hours for Change Filter reminder See Change Filter reminder section on page 3



To exit the menu: Set the system switch to Cool or Heat. If no keys are pressed within fifteen minutes, the thermostat will revert to normal operation.

Select Cycle Rate – The cycle rate can be adjusted to keep the heat or cool on longer or shorter to match the temperature response of the home with your heating and cooling system.

MODE	Fast (FA)	Medium (ME)	Slow (SL)
SS Heat	0.6°F	0.8°F	1.2°F
SS Cool	1.2°F		1.7°F
HP Heat & Cool	1.2°F		1.7°F

Troubleshooting

Reset Operation

If a voltage spike or static discharge blanks out the display or causes erratic thermostat operation, you may need to reset the thermostat. To reset, the System Switch must be in **Cool** or **Heat**. Simultaneously press  and  buttons

for approximately 10 seconds until the display goes blank. If the thermostat has power, has been reset and still does not function correctly contact your heating/cooling service person or place of purchase.

Symptom	Possible Cause	Corrective Action
No Heat/No Cool/No Fan common problems)	<ol style="list-style-type: none"> 1. Blown fuse or tripped circuit breaker. 2. Furnace power switch to OFF. 3. Furnace blower compartment door or panel loose or not properly installed. 	<ol style="list-style-type: none"> 1. Replace fuse or reset breaker. 2. Turn switch to ON. 3. Replace door panel in proper position to engage safety interlock or door switch.
No Heat	<ol style="list-style-type: none"> 1. System Switch not set to Heat. 2. Loose connection to thermostat or system 3. Heating System requires service or thermostat requires replacement. 	<ol style="list-style-type: none"> 1. Set System Switch to Heat and raise setpoint above room temperature. 2. Verify thermostat and system wires are securely attached. 3. Diagnostic: Set System Switch to Heat and raise the setpoint above room temperature. Within a five minutes the thermostat should make a soft click sound. This sound usually indicates the thermostat is operating properly. If the thermostat does not click, try the reset operation listed above. If the thermostat does not click after being reset contact your heating and cooling service person or place of purchase for a replacement. If the thermostat clicks, contact the furnace manufacturer or a service person to verify the heating system is operating correctly.
No Cool	<ol style="list-style-type: none"> 1. System Switch not set to Cool. 2. Loose connection to thermostat or system. 3. Cooling System requires service or thermostat requires replacement 	<ol style="list-style-type: none"> 1. Set System Switch to Cool and lower setpoint below room temperature. 2. Verify thermostat and system wires are securely attached. 3. Same procedures as diagnostic for No Heat condition except set the thermostat to Cool and lower the setpoint below the room temperature. There may be up to a five minute delay before the thermostat clicks in Cooling if the compressor lock-out option is selected in the configuration menu (Item 6).
Heat, Cool or Fan Runs Constantly	<ol style="list-style-type: none"> 1. Possible short in wiring. 2. Possible short in thermostat. 3. Possible short in Heat/Cool/Fan system. 4. Fan Switch set to Fan On. 	<p>Check each wire connection to verify they are not shorted or touching together. No bare wire should stick out from under terminal screws. Try resetting the thermostat as described above. If the condition persists, the manufacturer of your system or service person can instruct you on how to test the Heat/Cool/ system for correct operation. If the system operates correctly, replace the thermostat.</p>
Furnace Cycles Too Fast or Too Slow / Cooling Cycles Too Fast or Too Slow (narrow or wide temperature swing)	<ol style="list-style-type: none"> 1. The location of the thermostat and/or the size of the Heating or Cooling System may be influencing the cycle rate. 	<p>Item 4 (CR Heat) or 5 (CR Cool) in the Configuration Menu is the adjustment that controls the cycle rate. If an acceptable cycle rate is not achieved using the FA (Fast) or SL (Slow) adjustment contact a local service person for additional suggestions.</p>
Thermostat Setting and Thermometer Disagree	<ol style="list-style-type: none"> 1. Thermostat thermometer setting requires adjustment. 	<p>The thermometer can be adjusted +/- degrees as listed in item 8 of the Configuration Menu (see page 5). No other adjustment is possible.</p>
Blank Display and/or Keypad Not Responding	<ol style="list-style-type: none"> 1. Voltage Spike or Static Discharge. 	<p>If a voltage spike or static discharge occurs use the Reset Operation listed above.</p>

Figure 2. Typical wiring diagram for single transformer single stage systems

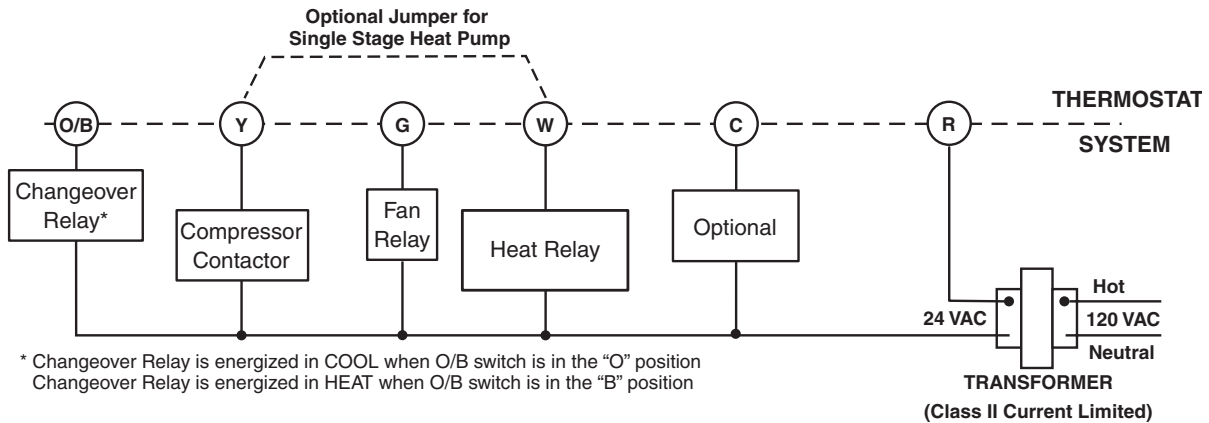

Figure 3. Typical wiring diagram for two transformer single stage systems with NO safety circuits

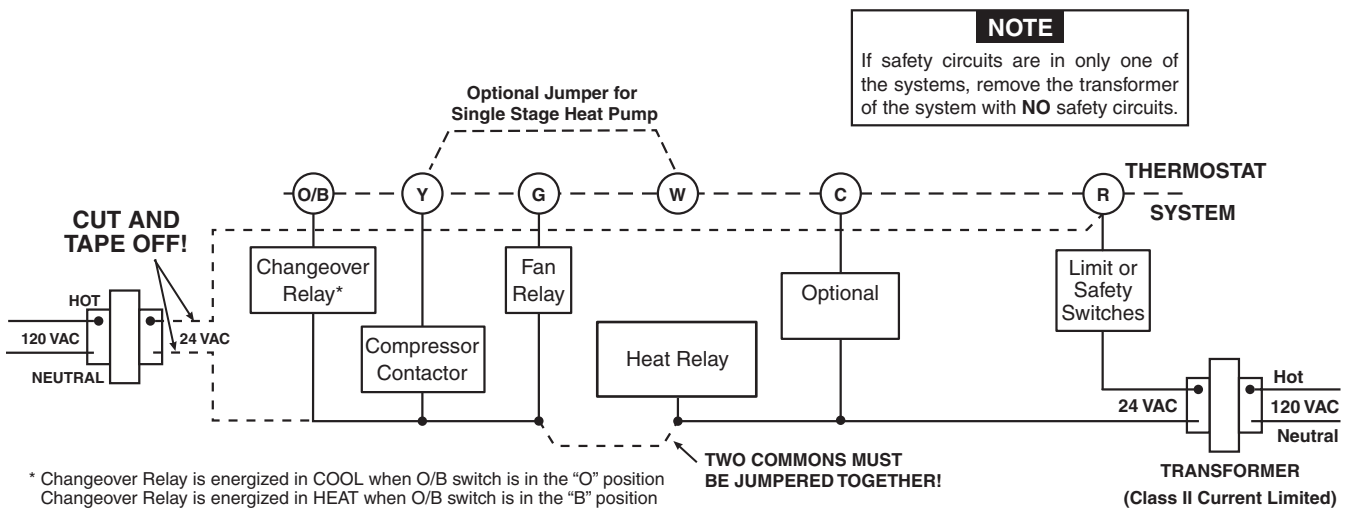
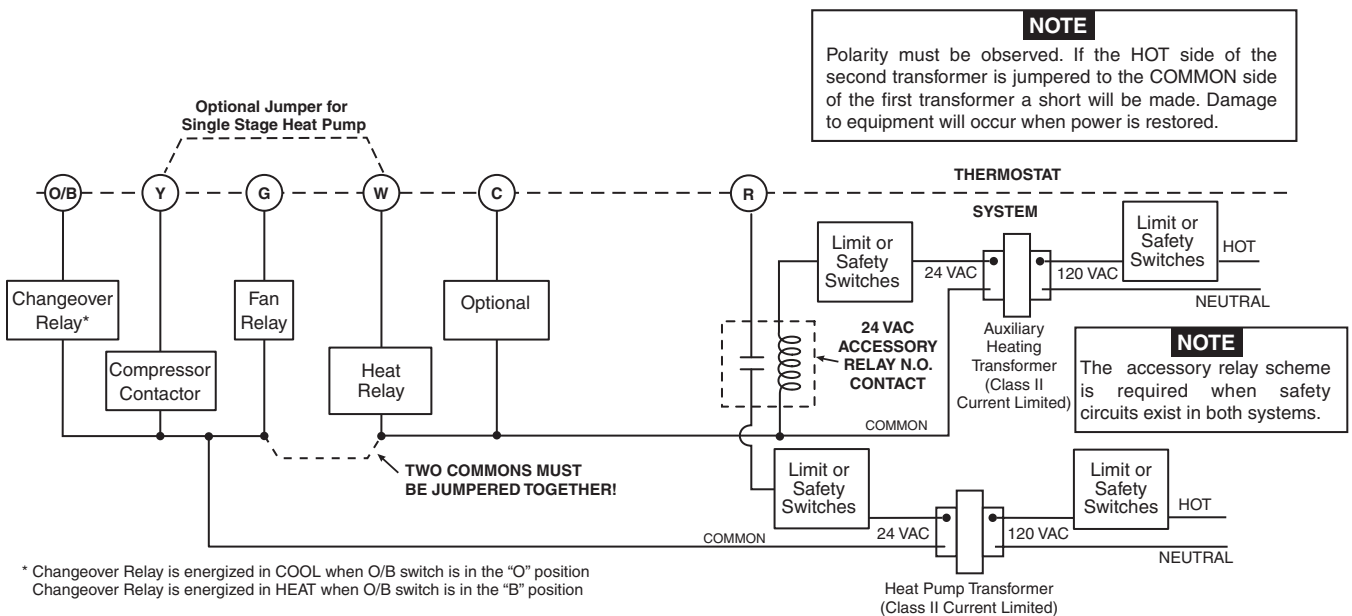

Figure 4. Typical wiring diagram for two transformer single stage systems with safety circuits in BOTH systems



Technical Data

THERMOSTAT APPLICATION GUIDE

Thermostat Configuration Options	Thermostat Applications	Maximum Stages Heat/Cool
Single Stage 1 No Heat Pump (SS)	Gas, Oil, Electric, Heat Only, Cool Only or Heat / Cool Systems	1/1
Heat Pump 1 Single Stage Compressor Heat Pump (HP)	Single Stage Compressor Heat Pump Systems - with no Aux. Heat	1/1

ATTENTION!

This product does not contain mercury. However, this product may replace a unit which contains mercury.

Do not open mercury cells. If a cell becomes damaged, do not touch any spilled mercury. Wearing nonabsorbent gloves, take up the spilled mercury and place into a container which can be sealed. If a cell becomes damaged, the unit should be discarded.

Mercury must not be discarded in household trash. When the unit this product is replacing is to be discarded, place in a suitable container. Refer to www.white-roddgers.com for location to send the product containing mercury.

Specifications

Electrical Rating:

Battery Power	mV to 30 VAC, 50/60 Hz or DC
Input-Hardwire	20 to 30 VAC
Terminal Load	1.0 A per terminal, 1.5A maximum all terminals combined
Setpoint Range	45° to 90°F (7° to 32°C)
Differential (Single Stage)	Heat 0.6°F; Cool 1.2°F (adjustable)
Differential (Heat Pump)	Heat 1.2°F; Cool 1.2°F (adjustable)
Operating Ambient	32° to +105°F (0° to +41°C)
Operating Humidity	90% non-condensing max.
Shipping Temperature Range	-40° to +150°F (-40° to +65°C)
Dimensions Thermostat	3-3/4" H x 4-3/4" W x 1-1/2" D

Homeowner Help Line: 1-800-284-2925

White
Rodgers™

White-Rodgers is a division of Emerson Electric Co.

The Emerson logo is a trademark and service mark of Emerson Electric Co.

www.white-roddgers.com
www.emersonclimate.com

EMERSON™
Climate Technologies