

**WINDSTER™**  
www.windsterhood.com

9848 Rush Street, Suite A, B, C.  
South El Monte, CA 91733  
TEL:(626)350-1015  
(626)350-5215  
FAX:(626)350-1254

© 2007 Windster Hoods, Inc.  
Specifications subject to change without notice.

**WINDSTER™**  
www.windsterhood.com

WALL HOOD

## OPERATION MANUAL

RA-33 Series  
RA-34 Series  
RA-35 Series



Please read and save this guide through before using your range hood  
Store the guide away in a safe place so that you will know where it is  
when you want to refer to it

## Table of Contents

A. Important Safety Instructions	P.1
B. Safety Notes	P.3
C. Tools and Materials Required	P.4
D. Ducting	P.4
E. Preparing the Range Hood	P.5
F. Preparing the Installation Location	P.6
G. Providing Electrical Power	P.7
H. Installation	P.9
a, Mounting Range Hood to Cabinet	P.9
b, Wall mount installation	P.10
c, Install Accessory	P.12
I. Halogen light replacement	P.13
J. Maintenance Instruction	P.14
K. Troubleshooting	P.14
L. Use and Care	P.15
M. Parts Layout Diagrams	P.16
N. Circuit Diagrams	P.19
O. Accessories	P.20
P. Specifications	P.20
Q. Diagrams	P.21

### WARNING

**Due to sharp edge, please wear  
"Safety Workman Gloves"  
for installation, cleaning, light bulb changing and  
dismantling to reduce the risk of any bodily injuries.**

Safety Workman Gloves



# WINDSTER™

### Defective Products:

All products will be inspected, tested, and carefully packed by the manufacturer before shipping to customers. Products that are damaged during transit can only be exchanged for the same product, under the condition that the customer must get a RMA (Return Merchandise Authorization) from Windster. When products are received defective, you must notify us within the 3 business days of receiving the package. Replacement products are only shipped when the RMA is issued. NO EXCEPTIONS.

### Return Policy

Windster offers only the best and highest quality products. If you are not satisfied with your purchase, please contact us within 3 business days of product arrival to obtain a Return Merchandise Authorization (RMA). Returns sent without a RMA will not be accepted. There will be a 25% re-stocking fee for every returned items. Shipping fee will also be deducted from the original purchase price. When returning a package, please include a copy of your purchase receipt. Use the original shipping box and packing materials and completely remove or cover the original shipping label. Make sure that products are in brand new condition, uninstalled, un-drilled, and contain everything that came with the package as when you first received it. If any parts or manuals are missing, we have the right not to accept the return.

We suggest that you use a traceable and reputable carrier of your choice to ship your return. Your credit or refund will be processed within 10-14 business days from the date we receive your return.

# WINDSTER™

## Limited Warranty

**Windster Hoods Inc.** warrants this product against defects in material or workmanship as follows:

- 1) **Labor:** For a period of one (1) year from the date of purchase, if this product is determined to be defective, Windster will repair or replace the product, at its option, at no charge. After the warranty period, you must pay for all labor charges. During the labor warranty period there will be no charge for labor.
- 2) **Parts:** In addition, Windster will supply, at no charge, new or rebuilt replacements in exchange for defective parts for a period of two (2) years. After the warranty period, you must pay for all parts costs. During the parts warranty period, there will be no charge for parts

You must carry-in or mail-in your product during the warranty period. This warranty only applies to products purchased and serviced in the United States or Canada.

### What Is Not Covered By These Warranties:

- 1) Conditions and damages resulting from any of the following:
  - Improper installation, delivery, or maintenance.
  - Any repair, modification, alteration or adjustment not authorized by the manufacturer or an authorized service dealers.
  - Misuse, abuse, accidents, or unreasonable use.
  - Incorrect electric current, voltage or supply.
  - Improper setting of any control.
  - Improper chemical cleaning.
- 2) Light Bulbs
- 3) Products purchased for commercial or industrial use (such as in a hotel, office, restaurant, or other business)
- 4) Damage due to earthquake, flood, storm, etc.

## A. Important Safety Instructions

### Read and Save These Instructions

**CAUTION-** To reduce risk of fire and to properly exhaust air, be sure to duct air outside- Do not vent exhaust air into spaces within walls or ceilings or into attics, crawl spaces, or garages.

**WARNING-** To reduce the risk of fire or electric shock, do not use this fan with any solid- state speed control device.

**WARNING-** To reduce the risk of fire, electric shock, or injury to persons, observe the following:

- A. Use this unit only in the manner intended by the manufacturer. if you have questions, contact the manufacturer.
- B. Before servicing or cleaning unit, switch power off at service panel to prevent power from being switched on accidentally.

**CAUTION-** For general ventilating use only. Do not use to exhaust hazardous or explosive materials and vapours.

**WARNING-** To reduce the risk of a range top grease fire:

- A- Never leave surface units unattended at high settings. Boilovers cause smoking and greasy spillovers that may ignite. Heat oils slowly on low or medium settings.
- B- Always turn hood on when cooking at high heat or when cooking flaming foods.
- C- Clean ventilating fans frequently. Grease should not be allowed to accumulate on fan.
- D- Use proper pan size. Always use cookware appropriate for the size of the surface element.

**WARNING-** To reduce the risk of injury to persons in the event of arrange top grease fire, observe the following:

A- **SMOTHER FLAMES** with a close- fitting lid, cookie sheet, or metal tray, then turn off the burner. Be careful to prevent burns. If the flames do not go out immediately, **EVACUATE AND CALL THE FIRE DEPARTMENT.**

B- **NEVER PICK UP A FLAMING PAN-** You may be burned.

C- **DO NOT USE WATER** including wet dishcloths or towels- a violent steam explosion will result.

D- **USE AN EXTINGUISHER ONLY IF:**

1. You know you have a CLASS ABC extinguisher, and you already know how to operate it.
2. The fire is small and contained in the area where it started.
3. The fire department is being called.
4. You can fight the fire with your back against the exit.

**WARNING-** Sufficient air is needed for proper combustion and exhausting of gases through the flue (chimney) of fuel burning equipment to prevent back drafting. Follow the heating equipment manufacturer's guideline and safety standards such as these published by the National Fire Protection Association (NFPA), and the American Society for Heating, Refrigeration and Air Conditioning Engineers (ASHRAE), and the local code authorities.

Keep the range hood clean.

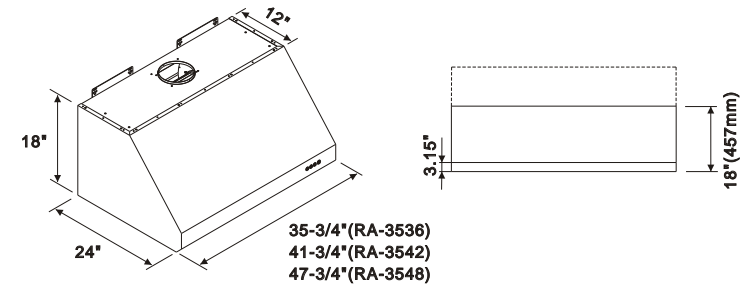

**Optional Accessories**

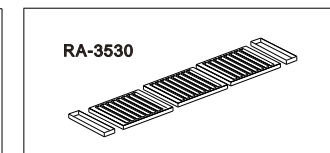
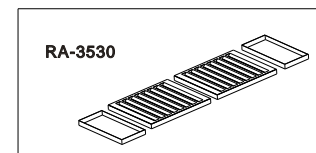
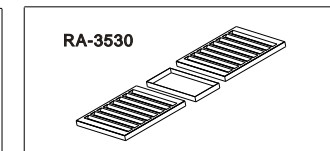
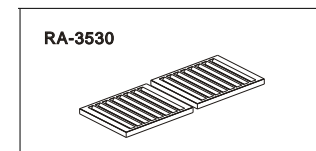
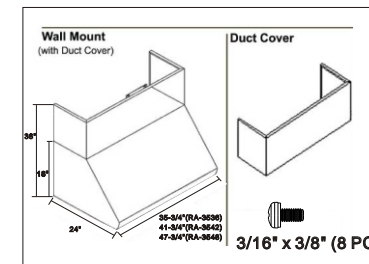

**Model :** RA-3530 : W 29-3/4" x D 24" x H 18"  
RA-3536 : W 35-3/4" x D 24" x H 18"  
RA-3542 : W 41-3/4" x D 24" x H 18"  
RA-3548 : W 47-3/4" x D 24" x H 18"

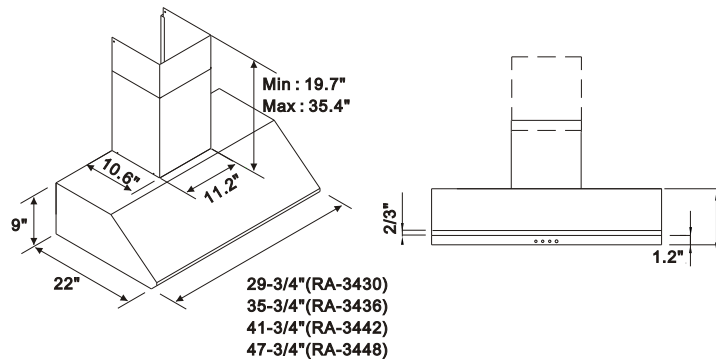

RA-3430

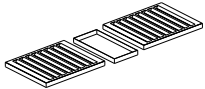

RA-3436

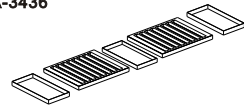

RA-3442

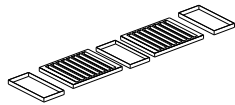

RA-3448

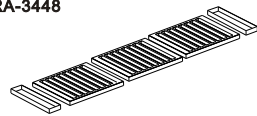

**i** Model : RA-3430 : W 29-3/4" x D 22" x H 9"  
RA-3436 : W 35-3/4" x D 22" x H 9"  
RA-3442 : W 41-3/4" x D 22" x H 9"  
RA-3448 : W 47-3/4" x D 22" x H 9"

## B. Safety Notes

1. All electrical work must be done in accordance with local and/or national electrical code as applicable for safety. This product must be grounded if you are unfamiliar with methods of installing electrical wiring, secure the services of a qualified electrician.
2. Turn off power at service entrance before installing wiring or servicing this product. (120 volt for range hood. 220 volt for electric range if any)
3. Turn off power to avoid risk of fire, electric shock or injury to person for cleaning or maintenance such as lubrication.
4. Fireplaces, gas furnaces, water heaters and the like require proper flow of combustion air and exhaust. Make sure this flow is not altered when using any exhaust fan.
5. Please read specifications label on product for further information and requirements.
6. Please wear "Safety Gloves" for installation, cleaning, light bulb changing and dismantling to reduce the risk of any bodily injuries.

**CAUTION-** To reduce the risk of fire and to properly exhaust air, be sure to duct air outside. Do not vent exhaust air into spaces within walls or ceilings or into attics crawl spaces or garages.

## C. Tools and Materials Required

- ▶ Drill, electric or ratchet drive, with 3/16" wood bit (for drilling starter holes and 1 1/4" wood bit (to drill an access holes in the cabinet or kitchen wall for the electric power line)
- ▶ One common screwdriver.
- ▶ Plier (for opening electrical knockout).
- ▶ Two 1" (thick)x2" (wide)x12" (approximate length) wood strips for recessed bottom kitchen cabinet installation only. (If needed, purchase locally)
- ▶ Electrical wire and supplies to comply with local cords.
- ▶ Four 1 1/4" long flat head wood screws (purchase locally) to mount wood strips.
- ▶ Pencil and ruler for marking locations. Saber saw or keyhole saw for cutting the 1"x2" wood strips to length.

## D. Ducting

This style of range hood must be vented via ducting to the outside of the house. Follow general rules when ducting the hood: Use correct size of ducting at least 6" round, do not reduce size of ducting, make all turns gradual, no short corners. If ducting ran will be longer than 10 feet enlarge duct by at least 1" inch diameter after each 10 feet. Tape all joints in ducting and all gasketed openings on hood for a tight seal.

For round ducting from the top:



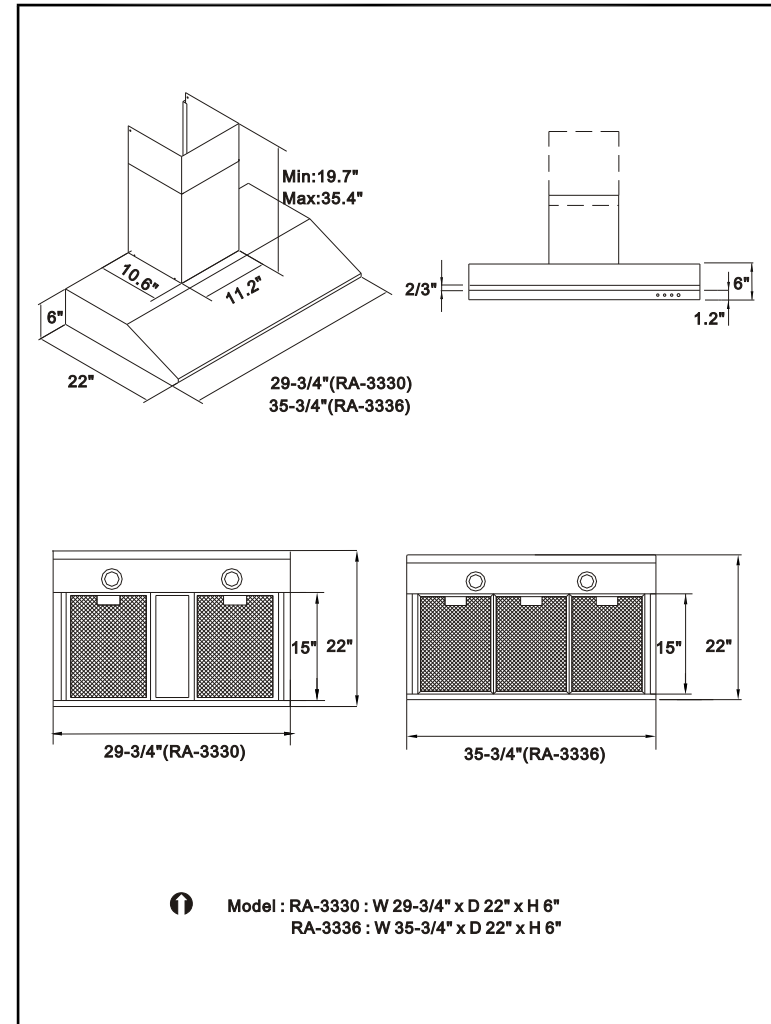

Fit the gray or white plastic (Included) over the circular opening on top in order to provide a tight seal for ducting to attach to. The duct ring is designed to fit 6" and 7" ducting.

## Q. Diagrams







## O. Accessories

RA-33, 34 Series

Spare Parts Contents										
Item	Part	Description	Spec.	Q'ty	Item	Part	Description	Spec.	Q'ty	
1		Manual		1	4		Screws	Ø4x32	4	
2		Round Collar	6"/7"	1				Plastic Screws	1/4"	4
3		Toggle Bolts	#3/16"x3"	2						

RA-35 Series

Spare Parts Contents									
Item	Part	Description	Spec.	Q'ty	Item	Part	Description	Spec.	Q'ty
1		Manual		1	4		Screws	Ø4x32	4
2		Round Collar		1				Plastic Screws	1/4"

## P. Specifications

Specifications	RA-3330C / RA-3336C RA-3430B / RA-3436B / RA-3442B	RA-3448B
Revolutions	Low - 590± 50 R.P.M. High - 1650± 50 R.P.M.	
Consumption - Motor	180W	
Consumption - Lamp	20W / 12V Halogen Light x 2	x 3
Rotation	Squirrel Cage	
Diameter Exhausting Duct	Top 6" Round / Top 7" Round Adapter	
Voltage	120V / 60 Hz	
Appearance Treatment	Brushed Stainless Steel	

Specifications	RA-3530 / RA-3536 / RA-3542	RA-3548
Revolutions	Low - 690± 50 R.P.M. High - 1660± 50 R.P.M.	
Consumption - Motor	180W	
Consumption - Lamp	20W / 12V Halogen Light x 2	x 3
Rotation	Squirrel Cage	
Diameter Exhausting Duct	Top 6" Round / Top 7" Round Adapter	
Voltage	120V / 60 Hz	
Appearance Treatment	Brushed Stainless Steel	

## E. Preparing The Range Hood

1. Remove the top electrical knockout, you may plan to bring power to the range hood either through the cabinet or through the wall (Fig.1)

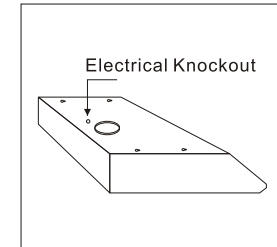

Fig.1

2. Insert a screwdriver into the knockout slot and bend the knockout back and forth. (Fig.2)  
You may have to use pliers to pull the loosened knockout free. (Fig.3)

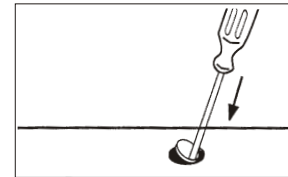

Fig.2



Fig.3

### Note:

When installed, the bottom edge of your range hood should be 28" ~ 32" above the top of the cooking surface. (Fig.4)

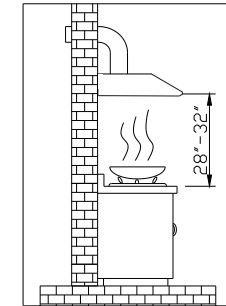

Fig.4

## F. Preparing The Installation Location

1. A. If you want to move the electric range to make room for working on the cabinet turn off the 220 volt power for the electric range at the service entrance.  
 B. Before moving a gas range, shut off the gas.

B. Before moving a gas range, shut off the gas.

**Note:** Skip steps 2a through 2d if the hood is to be mounted on a cabinet with a flush bottom.

2. For installation onto a recessed bottom cabinet:
  - a. Measure the space (under the cabinet between the inside front edge and inside back edge (Fig.5). With a saber, cut two 1"x2" wood filler strips (purchased locally) to fill in the bottom of the cabinet.
  - b. Start a 1 ¼" long wood screw (purchased locally) about 3" from each end of the 1"x2" wood strips (Fig.6)
  - c. Position the strips on the cabinet bottom and screw the strips securely to the cabinet (Fig.7)
  - d. For a more secure installation, drill four 3/16" holes from inside the cabinet, down into the wood filler strips. Insert screws into the starter holes in cabinet and tighten screws until wood filler strips are secured under cabinet.
3. Center the hood in place beneath the cabinet and flush with the front of the cabinet. Mark the following:
  - a. The four keyhole mounting slots for the hood. Mark these onto the bottom of the cabinet; or, if the cabinet bottom is recessed. Onto the wood strips (Fig.7)
  - b. The electrical knockout hole. (Fig.1)

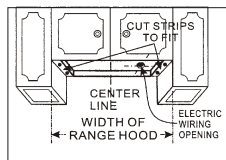

Fig.5

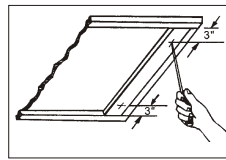
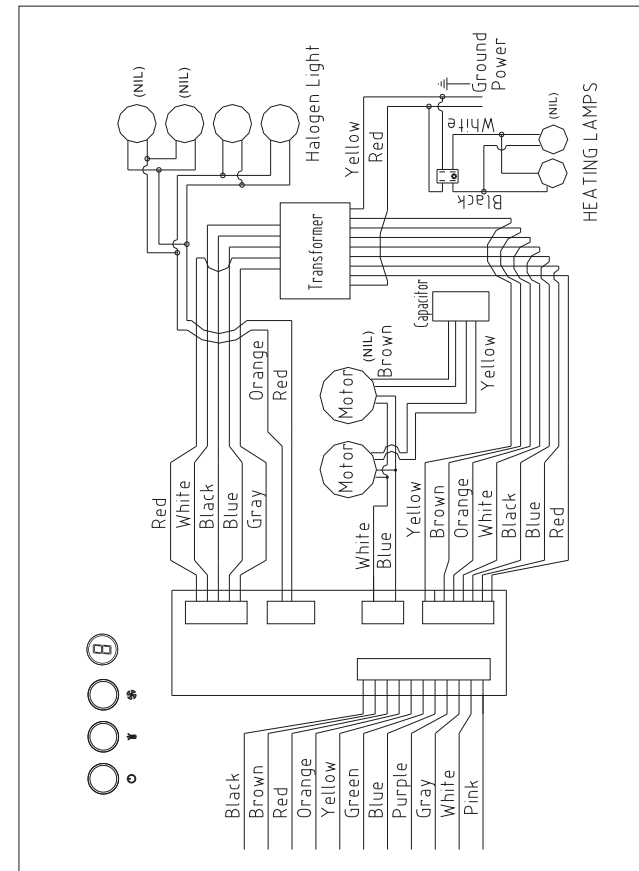

Fig.6

## N. Circuit Diagrams

Details the internal electrical circuit of this range hood unit. Any faults with this unit should only be attended to by a qualified technician.





MODEL :  
 RA-3530  
 RA-3536  
 RA-3542  
 RA-3548

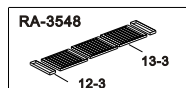
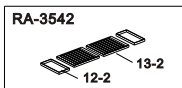
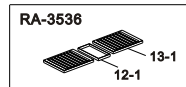
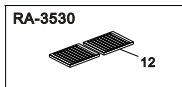
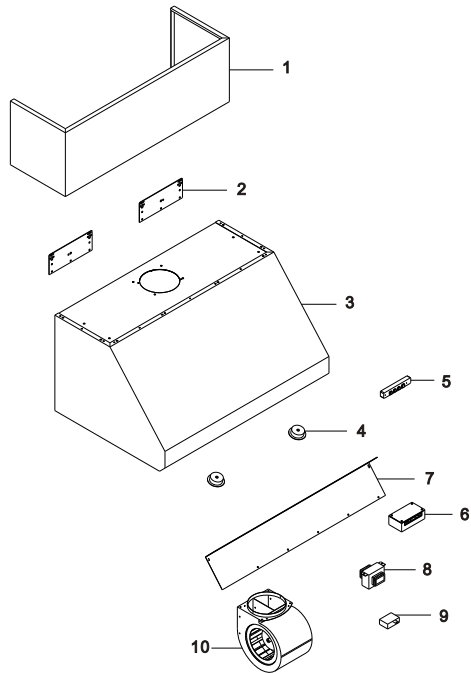

1	Duct Cover	7	Capacitor Support
2	Hood-Mounting Bracket	8	Transformer
3	Hood Casing	9	Capacitor
4	Halogen Light	10	Squirrel Cage
5	Control Board	11	Stainless steel spacer (11-1.11-2.11-3)
6	Processor Board	12	Baffle Filter (12-1.12-2.12-3)

- Screw the four 1" wood screws (for mounting the hood) into the exact center of the arrow and of the keyhole mounting slots marked on the cabinet bottom (for flush installations), or marked on the 1"x2" wood strips (for recessed cabinet installation) (Fig.7)  
 Do not turn the mounting screws in all the way. Allow 3/8" of screw to project, so the hood can be fitted place. (The screws will be tightened later)

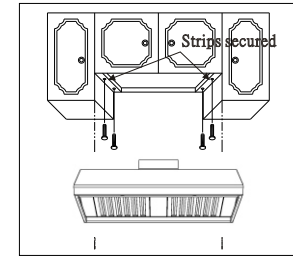

Fig.7

### G. Providing Electrical Power

- After turning off the proper 120 volt circuit at the service entrance, drill out the electrical power line access hole marked on the cabinet bottom or wall. Use a 1 1/4" wood bit. To operate the electric drill, use an extension cord connected to another circuit. (Fig.8)

#### Safety Warning:

If drilling into the walls, be careful not to cut existing electrical cabbies, which would create a hazard.

- Fish the electrical power line through the access hole drilled in the wall or bottom of the cabinet. Attach an appropriate connector (purchased locally) to the end of the power line for the type of wiring being installed. Follow all codes.(Fig.9)

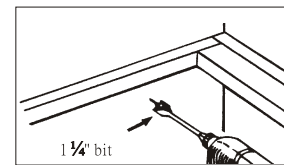

Fig.8

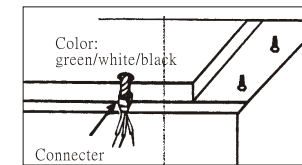

Fig.9

## WIRING TO POWER SUPPLY

### SAFETY WARNING

RISK OF ELECTRICAL SHOCK. THIS RANGE HOOD MUST BE PROPERLY GROUNDED. MAKE SURE THIS IS DONE BY SPECIALIZED ELECTRICIAN IN ACCORDANCE WITH ALL APPLICABLE NATIONAL AND LOCAL ELECTRICAL CODES. BEFORE CONNECTING WIRES, SWITCH POWER OFF AT SERVICE PANEL AND LOCK SERVICE PANEL TO PREVENT POWER FROM BEING SWITCHED ON ACCIDENTALLY.

Connect the electrical wires.

- Connect three wires (black, white and green) to house wires and cap with wire connectors. Connect according to color: black to black, white to white, and green to green as shown on Figure A.
- If necessary to hide the electrical wire connections, push wires back into the wiring box. Access the wire connections underneath the hood. Make sure wires do not slip between motor or any moving parts to prevent any damage.

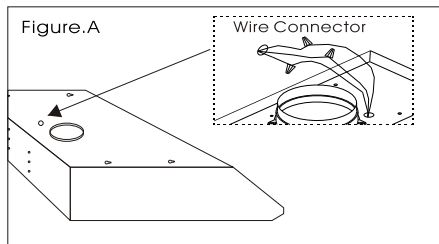

MODEL :  
RA-3430  
RA-3436  
RA-3442  
RA-3448

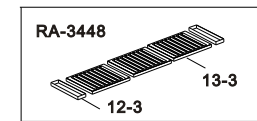
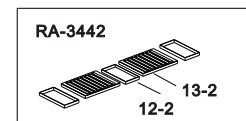
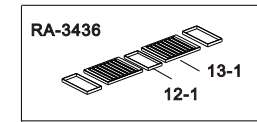
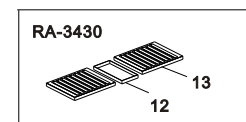
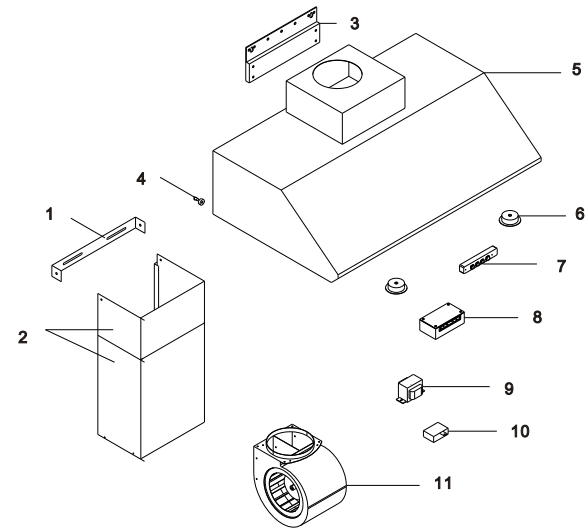

1	Duct Cover-Mounting Bracket	7	Control Board	13	Baffle Filter (13-1.13-2.13-3)
2	Duct Cover	8	Processor Board		
3	Hood-Mounting Bracket	9	Transformer		
4	Rubber Stand	10	Capacitor		
5	Hood Casing (5-1.5-2.5-3)	11	Squirrel Cage		
6	Halogen Light	12	Stainless Steel spacer (12-1.12-2.12-3)		

## M. Parts layout diagrams

MODEL :  
RA-3330  
RA-3336

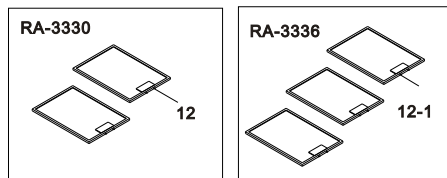
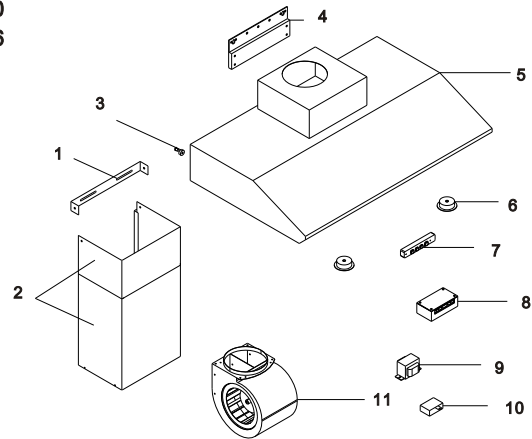

1.	Duct Cover-Mounting Bracket	8.	Processor Board
2.	Duct Cover	9.	Transformer
3.	Hood-Mounting Bracket	10.	Capacitor
4.	Rubber Stand	11.	Squirrel Cage
5.	Hood Casing	12.	Aluminum Filter (12-1)
6.	Halogen Light		
7.	Control Board		

## H. Installation

### a. Mounting Range Hood To Cabinet

1. Position the hood in place so that :
  - a. The electrical line is routed through the appropriate Knockout opening. This step will have to be accomplished while positioning the hood (Fig. 10)
  - b. The large part of the keyhole mounting slots on the hood fit onto the hood mounting screws projecting from the bottom of the cabinet. (Fig.11)
2. Adjust the hood so the front is flush with the cabinet front.
3. Tighten the hood mounting screws all the way into the cabinet or into the 1" x 2" wood strips so the hood is secure.

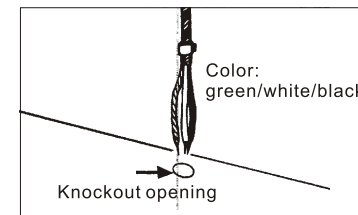

Fig.10

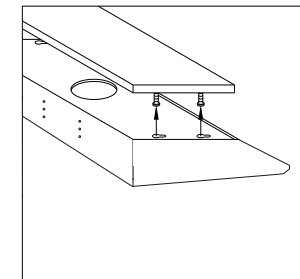

Fig.11

## b. Wall Mount Installation

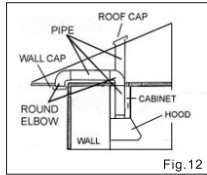

Fig.12

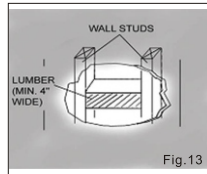

Fig.13

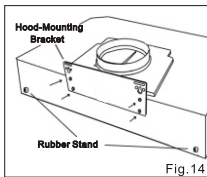

Fig.14

RA-33/RA-34 Series

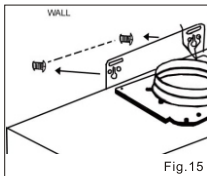

Fig.15

RA-33/RA-34 Series

- a. Decide the location and measure the length of venting pipe from the hood to the outside. (Fig.12)
- b. The less transition, elbows, the more exhaust power performance of the hood.
- Prepare back wall frame with cross framing lumber (purchase locally) and fix in the appropriation for secure installation (Fig.13)
- Test for proper operation by temporarily wire the hood before installing.
- Attach two rubber stands (included) with two (4\*8mm) screws (included) if necessary, to the back of the hood.
- Attach the hood - mounting bracket to the back of the hood with four (3/16" x 3/8" ) screws (included) (Fig.14)
- a. Mark the levelling of the hood position two mounting screws (not included) on the wall, leaving 1/8" away from the wall.
- b. Align hood-mounting bracket to the screws on the wall and hook into place as Fig.15, Tighten screws to secure hood to the wall.

## L. Use and care

**Note:** Operate switches (Fig.25)

Switch 1 : LED Speed Indicator.

Ⓟ - Low speed Ⓛ - High speed

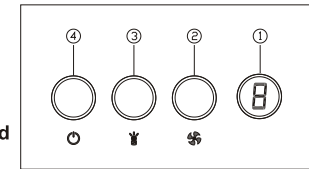

Fig.25

Switch 2 : Speed switch (Six speed fan)

Switch 3 : Light switch (Three light levels)

Switch 4 : Power switch and delay switch.

Push once : Delayed shut off.

Push twice : Immediate shut off.

### **Note:**

Range hood should be turn on either before or the same time when cooking begins. After cooking, range hood should be kept on for about 3 more minutes for complete ventilation of cooking odor.

### **Care Instruction:**

Please always pull the plug out before cleaning or dismantling, wear 'Safety gloves' to reduce the risk of any injuries.

Exterior: Can be clean with any type of non-abrasive detergent and a clean cloth. "Green Pad" or any metal type cleaning pad is not recommended for exterior.

## J. Maintenance Instruction

1. Maintenance should be important than repair. Please take care of the needed maintenance in order to secure and extend the excellent functions and using life.

### Note:

Before repairing the range hood. Disconnect the power source.

2. After using the machine, wipes the machine by neutral detergent in order to keep it clean and maintain the appearance with brightness and sanitation.

3. When the level of dirty oil of the collector reached 4/5 of height, it has to be removed in order to avoid overflowing and pollution.

## K. Troubleshootings

Symptom	Correction
Fan are not operatable.	A. Check power source to see if it is normal. B. Check power inlet plug to see if it is plugged firmly into it's socket.
Illuminating indicator lamp burned out light.	A. Disconnect the power source. B. Check lamp bulb, replace it with a new one if it is burned out.
Hood vibrates.	A. Check for damaged vanes. B. Check if exhaust duct is secured.

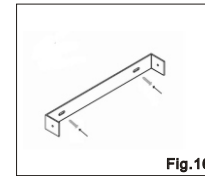

Fig.16

RA-33/RA-34 Series

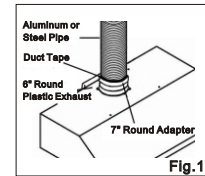

Fig.17

RA-33/RA-34 Series

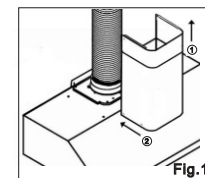

Fig.18

RA-33/RA-34 Series

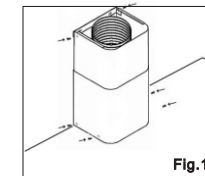

Fig.19

RA-33/RA-34 Series

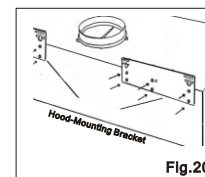

Fig.20

RA-35 Series

- Mark the desired position of the duct cover mounting bracket on the wall. Fix and secure duct cover mounting bracket with two screws (not included). (Fig.16 )

- Apply with aluminum or steel pipe to connect the plastic exhaust duct on the hood. Use duct tape to make all joints secure and ensure air tight. (Fig.17 )

- Slide the inner duct cover up 2 inches before sliding the entire duct cover on the hood. (Fig.18 )

- 1. Adjust the height of the inner duct cover to the duct cover-mounting bracket. Secure the inner duct cover with two (4 x 8 mm) screws (not included) (Fig.19 )
- 2. Fasten out duct cover to plastic plate on the hood with four (4 x 8 mm) screws (not included) (Fig.19 )

- Apply with twelve (3/16" x 3/8" ) screws (included) to fix the two hood-mounting brackets (included) to the back of the hood. (Fig.20 )

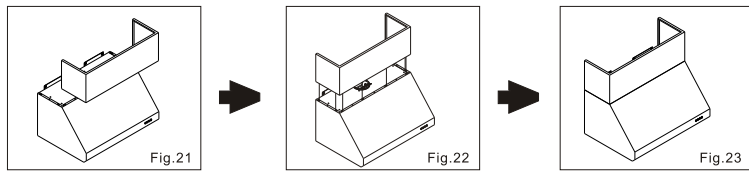

RA-35 Series

RA-35 Series

RA-35 Series

1. After pipe duct, take out all the baffle filters and spacers. (Fig.21 )
2. Slide the duct cover onward from the top of hood. (Fig.21 )
3. Check the eight screw holes of duct cover already right sit on the top of hood. (Fig.22 )
4. Fix eight screws (included)from the interior of hood up to the hood and fastened. (Fig.22 )
5. Complete installation. (Fig.23)

### c. Install Accessory

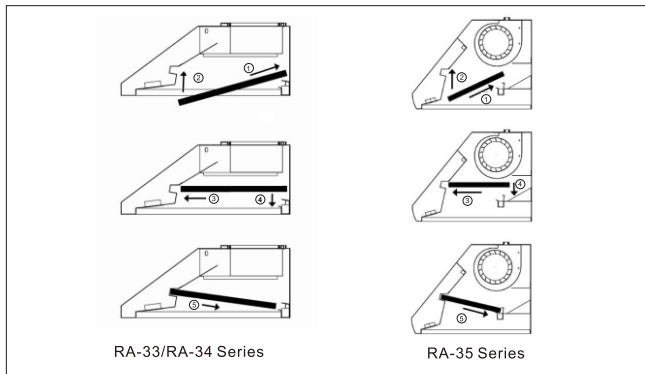

RA-33/RA-34 Series

RA-35 Series

Fig.24

1. Refer to Fig. 24
  - ① Slide the baffle filter into the hood.
  - ② Push the baffle filter up ward.
  - ③ Slide forward.
  - ④ Pull downward.
  - ⑤ Fit into place.
2. For bottom casing, repeat above steps.

## I. Halogen light replacement

### Note:

The halogen light will be very hot when it is working Never touch it with bare hand.

Before changing halogen light ensure the unit is switched off and the halogen light is cool.

Halogen light spec: 12V / 20W

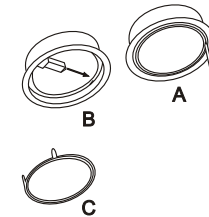

**Note:** Ensure the unit is switched off. Before changing lamp.

- A. Using suitable tool (small screw driver) gently pry off the lamp cover len.
- B. Remove the unserviceable Lamp. Replace the removed lamp with serviceable new lamp, taking note not to touch the glass lamp surface with your bare fingers. (Use a suitable cloth).
- C. Replace the len cap and reconnect the power and test lamp.

**WARNING:** To reduce the risk of a range top grease fire.

- A. Never leave surface units unattended at high settings. Boilovers cause smoking and greasy spillovers that may ignite. Heat oils slowly on low or medium settings.
- B. Always turn hood on when cooking at high heat or when cooking open flame foods.
- C. Clean ventilating fans frequently. Grease should not be allowed to accumulate on fan.
- D. Use proper pan size. Always use cookware appropriate for the size of the surface element.