

SHARP®

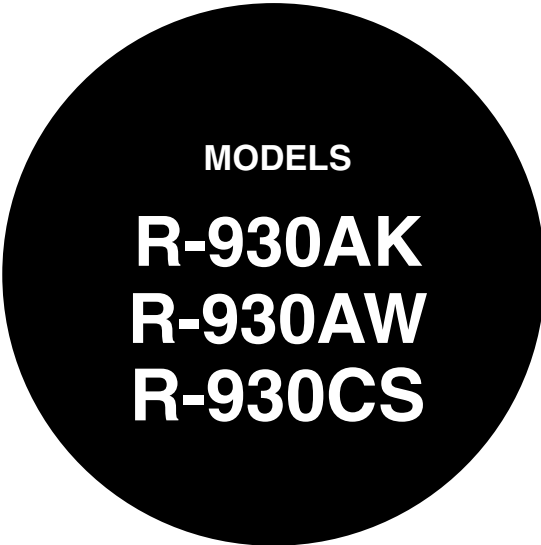

MICROWAVE OVEN OPERATION MANUAL

CONTENTS

- For Customer Assistance Inside Front Cover
- Precautions to Avoid Possible Exposure to Excessive Microwave Energy Inside Front Cover
- Limited Warranty 1
- Important Safety Instructions 2
- Installation Instructions 3
- Grounding Instructions 4
- Information You Need to Know 5
- Part Names 8
- Before Operating 10
- Manual Operation 10
- Special Features 15
- Other Convenient Features 24
- Cleaning and Care 26
- Service Call Check 27
- Specifications 27
- Guia Auto-Touch 28
- Auto-Touch Guide 29, Back Cover

CONVECTION



Read all instructions carefully before using your oven.

FOR CUSTOMER ASSISTANCE

To aid in reporting this microwave oven in case of loss or theft, please record below the model number and serial number located on the unit. We also suggest you record all the information listed and retain for future reference.

MODEL NUMBER _____ SERIAL NUMBER _____
DATE OF PURCHASE _____
Dealer _____ Telephone _____
Servicer _____ Telephone _____

TO PHONE: DIAL 1-800-BE-SHARP (1-800-237-4277) for :
SERVICE (for your nearest Sharp Authorized Servicer)
PARTS (for your authorized parts distributor)
ACCESSORIES
ADDITIONAL CUSTOMER INFORMATION

DIAL 1-800-642-2122 for :
ACCESSORIES and MICROWAVE ONLY COOKBOOK

DIAL (201)529-8703 for :
COOKING ASSISTANCE

TO WRITE:

For cooking and operation questions:

Susan Edwards/Test Kitchen
Sharp Electronics Corporation
Sharp Plaza, Box 650
Mahwah, NJ 07430-2135

For service problems, warranty information, missing items and other assistance:

Sharp Electronics Corporation
Customer Assistance Center
1300 Naperville Drive
Romeoville, IL 60446-1091

Please provide the following information when you write or call: model number, serial number, date of purchase, your complete mailing address (including zip code), your daytime telephone number (including area code) and description of the problem.

TO ACCESS INTERNET: www.sharp-usa.com

PRECAUTIONS TO AVOID POSSIBLE EXPOSURE TO EXCESSIVE MICROWAVE ENERGY

- (a) Do not attempt to operate this oven with the door open since open-door operation can result in harmful exposure to microwave energy. It is important not to defeat or tamper with the safety interlocks.
- (b) Do not place any object between the oven front face and the door or allow soil or cleaner residue to accumulate on sealing surfaces.
- (c) Do not operate the oven if it is damaged. It is particularly important that the oven door close properly and that there is no damage to the: (1) door (bent), (2) hinges and latches (broken or loosened), (3) door seals and sealing surfaces.
- (d) The oven should not be adjusted or repaired by anyone except properly qualified service personnel.

LIMITED WARRANTY

SHARP ELECTRONICS CORPORATION warrants to the first consumer purchaser that this Sharp brand product (the "Product"), when shipped in its original container, will be free from defective workmanship and materials, and agrees that it will, at its option, either repair the defect or replace the defective Product or part thereof with a new or remanufactured equivalent at no charge to the purchaser for parts or labor for the period(s) set forth below.

This warranty does not apply to any appearance items of the Product nor to the additional excluded item(s) set forth below nor to any Product the exterior of which has been damaged or defaced, which has been subjected to improper voltage or other misuse, abnormal service or handling, or which has been altered or modified in design or construction.

In order to enforce the rights under this limited warranty, the purchaser should follow the steps set forth below and provide proof of purchase to the servicer.

The limited warranty described herein is in addition to whatever implied warranties may be granted to purchasers by law. ALL IMPLIED WARRANTIES INCLUDING THE WARRANTIES OF MERCHANTABILITY AND FITNESS FOR USE ARE LIMITED TO THE PERIOD(S) FROM THE DATE OF PURCHASE SET FORTH BELOW. Some states do not allow limitations on how long an implied warranty lasts, so the above limitation may not apply to you.

Neither the sales personnel of the seller nor any other person is authorized to make any warranties other than those described herein, or to extend the duration of any warranties beyond the time period described herein on behalf of Sharp.

The warranties described herein shall be the sole and exclusive warranties granted by Sharp and shall be the sole and exclusive remedy available to the purchaser. Correction of defects, in the manner and for the period of time described herein, shall constitute complete fulfillment of all liabilities and responsibilities of Sharp to the purchaser with respect to the Product, and shall constitute full satisfaction of all claims, whether based on contract, negligence, strict liability or otherwise. In no event shall Sharp be liable, or in any way responsible, for any damages or defects in the Product which were caused by repairs or attempted repairs performed by anyone other than an authorized servicer. Nor shall Sharp be liable or in any way responsible for any incidental or consequential economic or property damage. Some states do not allow the exclusion of incidental or consequential damages, so the above exclusion may not apply to you. THIS WARRANTY GIVES YOU SPECIFIC LEGAL RIGHTS. YOU MAY ALSO HAVE OTHER RIGHTS WHICH VARY FROM STATE TO STATE.

Your Product Model Number & Description:

R-930AK, R-930AW or R-930CS Home Use Carousel Microwave Oven. (Be sure to have this information available when you need service for your Product.)

Warranty Period for this Product:

One (1) year parts and labor. The warranty period continues for an additional four (4) years, for a total of five (5) years, with respect to the magnetron tube in the Product for parts only; labor and service are not provided free of charge for this additional period.

Additional Item(s) Excluded from Warranty Coverage (if any):
Where to Obtain Service:

Non-functional accessories, turntable and light bulb.

From a Sharp Authorized Servicer located in the United States. To find the location of the nearest Sharp Authorized Servicer, call Sharp toll free at 1-800-BE-SHARP (1-800-237-4277).

What to do to Obtain Service:

Ship prepaid or carry in your Product to a Sharp Authorized Servicer. Be sure to have **Proof of Purchase** available. If you ship the Product, be sure it is insured and packaged securely. If your Product is built-in using Sharp Built-in Kit RK-66A, RK-66WB, RK-93S27 or RK-93S30 you may obtain in-home service during the initial one-year warranty period by contacting your Servicer. The Servicer will come to your home and if it is necessary to remove the product, the Servicer will reinstall it. Be sure to have proof of purchase available.

TO OBTAIN SUPPLY, ACCESSORY OR PRODUCT INFORMATION, CALL **1-800-BE-SHARP**. Save the proof of purchase as it is needed should your oven ever require warranty service.

PRODUCT INFORMATION CARD

The product information card which is on the inside of the microwave oven carton should be completed within ten days of purchase and returned. We will keep it on file and help you access the information in case of loss, damage or theft. This will also enable us to contact you in the unlikely event that any adjustments or modifications are ever required for your oven.

IMPORTANT SAFETY INSTRUCTIONS

When using electrical appliances basic safety precautions should be followed, including the following:

WARNING - To reduce the risk of burns, electric shock, fire, injury to persons or exposure to excessive microwave energy:

1. Read all instructions before using the appliance.
2. Read and follow the specific “PRECAUTIONS TO AVOID POSSIBLE EXPOSURE TO EXCESSIVE MICROWAVE ENERGY” on inside front cover.
3. This appliance must be grounded. Connect only to properly grounded outlet. See “GROUNDING INSTRUCTIONS” on page 4.
4. Install or locate this appliance only in accordance with the provided installation instructions.
5. Some products such as whole eggs and sealed containers -- for example, closed glass jars - - may explode and should not be heated in this oven.
6. Use this appliance only for its intended use as described in this manual. Do not use corrosive chemicals or vapors in this appliance. This type of oven is specifically designed to heat, cook or dry food. It is not designed for industrial or laboratory use.
7. As with any appliance, close supervision is necessary when used by children.
8. Do not operate this appliance if it has a damaged cord or plug, if it is not working properly or if it has been damaged or dropped.
9. This appliance should be serviced only by qualified service personnel. Contact nearest Sharp Authorized Servicer for examination, repair or adjustment.
10. Do not cover or block any openings on the appliance.
11. Do not store or use this appliance outdoors. Do not use this product near water--for example, near a kitchen sink, in a wet basement or near a swimming pool, and the like.
12. Do not immerse cord or plug in water.
13. Keep cord away from heated surfaces.
14. Do not let cord hang over edge of table or counter.
15. See door surface cleaning instructions on page 26.
16. To reduce the risk of fire in the oven cavity:
 - a. Do not overcook food. Carefully attend appliance if paper, plastic or other combustible materials are placed inside the oven to facilitate cooking.
 - b. Remove wire twist-ties from paper or plastic bags before placing bag in oven.
 - c. If materials inside the oven should ignite, keep oven door closed, turn oven off, and disconnect the power cord or shut off power at the fuse or circuit breaker panel.**
 - d. Do not use the cavity for storage purposes. Do not leave paper products, cooking utensils or food in the cavity when not in use.
17. Do not operate any heating or cooking appliance beneath this appliance.
18. Do not mount unit over or near any portion of a heating or cooking appliance.
19. Do not mount over a sink.
20. Do not store anything directly on top of the appliance surface when the appliance is in operation.
21. R-930AK and R-930AW are suitable for built-in installation over only General Electric’s wall oven models JKP18BW, JKP18WW and JKP18AW.
R-930CS is suitable for built-in installation over only General Electric’s wall oven model ZET837SYSS.

SAVE THESE INSTRUCTIONS

INSTALLATION INSTRUCTIONS

Unpacking and Examining Your Oven

Remove:

1. all packing materials from inside the oven cavity. Read enclosures and **SAVE** the Operation Manual. **DO NOT REMOVE AND THROW OUT THE WAVE GUIDE COVER.**
2. the feature sticker from the outside of the door, if there is one.

Check the oven for any damage, such as misaligned or bent door, damaged door seals and sealing surfaces, broken or loose door hinges and latches and dents inside the cavity or on the door. If there is any damage, do not operate the oven and contact your dealer or SHARP AUTHORIZED SERVICER.

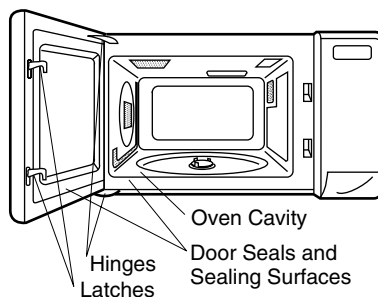

Choosing a Location for Your Oven

You will use your oven frequently so plan its location for ease of use. The oven must be placed on a countertop which is a minimum of 36 inches from the floor. Allow at least 2 inches on the sides, top and at the rear of the oven for air circulation. Be sure to position oven so that the rear cannot be touched inadvertently.

Your oven can be built into a cabinet or wall by itself or above any General Electric wall oven using Sharp's Built-in Kit listed below. It cannot be built in above conventional gas or electric ranges or any other wall ovens.

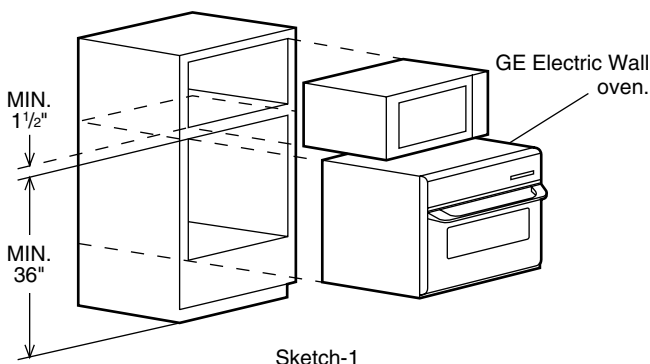

Sharp Microwave Oven Model	Applicable Built-in kits	Applicable G.E. Wall Ovens
R-930AK	RK-66A	JKP18BW JKP18WW
R-930AW	RK-66WB	JKP18AW
R-930CS	RK-93S27	
	RK-93S30	ZET-837SYSS

Note for R-930CS:

Select the Built-in kit RK-93S27 or RK-93S30 depending on the desired finished width. The RK-93S27 is for a 27 inch and the RK-93S30 is for a 30 inch finished width. The RK-93S27 cannot be used with any of the G.E. wall ovens.

See Sketch 1 for proper location when building in above the specified G.E. wall ovens. Carefully follow both the G.E. wall oven installation instructions and Sharp's Built-in Kit instructions. Be sure that the clearance of the floor between the wall oven and the microwave oven is minimum of 1 1/2 inches.

Ordering the Built-in Kits.

If your dealer does not stock the kit, it can be ordered directly from the Sharp Accessories and Supplies Center. Have your credit card number available and call toll-free: 1-800-642-2122 for ordering the kit to be sent to your address.

The kit includes ducts and finish trim strips and easy-to-follow instructions for installation as well as the location of the power supply.

GROUNDING INSTRUCTIONS

This appliance must be grounded. This oven is equipped with a cord having a grounding wire with a grounding plug. It must be plugged into a wall receptacle that is properly installed and grounded in accordance with the National Electrical Code and local codes and ordinances. In the event of an electrical short circuit, grounding reduces the risk of electric shock by providing an escape wire for the electric current.

WARNING – Improper use of the grounding plug can result in a risk of electric shock.

Electrical Requirements

The electrical requirements are a 120 volt 60 Hz, AC only, 15 amp. or more protected electrical supply. It is recommended that a separate circuit serving only the microwave oven be provided.

The oven is equipped with a 3-prong grounding plug. It must be plugged into a wall receptacle that is properly installed and grounded. Should you only have a 2-prong outlet, have a qualified electrician install a correct wall receptacle.

A 3-prong adapter may be purchased and used temporarily if local codes allow. Follow package directions.

A short power-supply cord is provided to reduce risk of becoming entangled in or tripping over a longer cord.

Extension Cord

If it is necessary to use an extension cord, use only a 3-wire extension cord that has a 3-blade grounding plug and a 3-slot receptacle that will accept the plug on the microwave oven. The marked rating of the extension cord should be AC 115-120 volt, 15 amp. or more.

Be careful not to drape the cord over the countertop or table where it can be pulled on by children or tripped over accidentally.

Note:

1. If you have any questions about the grounding or electrical instructions, consult a qualified electrician or service person.
2. Neither Sharp nor the dealer can accept any liability for damage to the oven or personal injury resulting from failure to observe the correct electrical connection procedures.

Radio or TV Interference

Should there be any interference caused by the microwave oven to your radio or TV, check that the microwave oven is on a different electrical circuit, relocate the radio or TV as far away from the oven as feasible or check position and signal of receiving antenna.

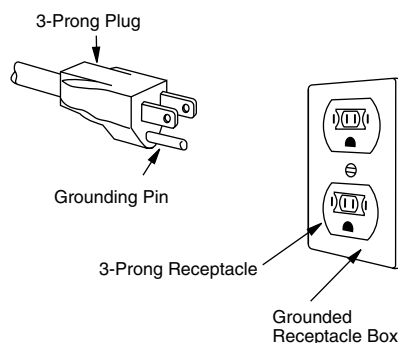

Permanent and Correct Installation

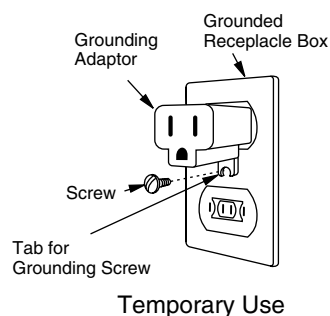

INFORMATION YOU NEED TO KNOW

About Your Oven

This Operation Manual is valuable: read it carefully and always save it for reference.

The Sharp Carousel Convection Microwave Cookbook is a valuable asset. Check it frequently for cooking principles, techniques, hints and recipes.

NEVER use the oven without the turntable and support nor turn the turntable over so that a large dish could be placed in the oven. The turntable will turn both clockwise and counterclockwise.

ALWAYS have food in the oven when it is on to absorb the microwave energy.

When using the oven at power levels below 100%, you may hear the magnetron cycling on and off.

Condensation is a normal part of microwave cooking. Room humidity and the moisture in food will influence the amount of moisture that condenses in the oven. Generally, covered foods will not cause as much condensation as uncovered ones. Vents on the oven back must not be blocked.

After using **convection, automatic mix or broil**, you will hear the sound of the cooling fan. The fan may continue to operate as long as 5 minutes, depending on the oven temperature.

Be aware that, unlike microwave-only ovens, convection microwave ovens have a tendency to become hot during **convection, automatic mix and broil** cooking.

The oven is for food preparation only. It should not be used to dry clothes or newspapers.

Your oven is rated 900 watts using the IEC Test Procedure. In using recipes or package directions, check food at the minimum time and add time accordingly.

About Food

	DO	DON'T
Eggs, sausages, nuts, seeds, fruits & vegetables	<ul style="list-style-type: none"> * Puncture egg yolks before cooking to prevent "explosion". * Pierce skins of potatoes, apples, squash, hot dogs and sausages so that steam escapes. 	<ul style="list-style-type: none"> * Cook eggs in shells. * Reheat whole eggs. * Dry nuts or seeds in shells.
Popcorn	<ul style="list-style-type: none"> * Use specially bagged popcorn for the microwave oven. * Listen while popping corn for the popping to slow to 1 or 2 seconds or use POPCORN pad for "no-guess" popping. * Use an overturned 9 or 10 inch oven proof glass pie plate on top of the turntable when popping bagged microwave popcorn. 	<ul style="list-style-type: none"> * Pop popcorn in regular brown bags or glass bowls. * Exceed maximum time on popcorn package.
Baby food	<ul style="list-style-type: none"> * Transfer baby food to small dish and heat carefully, stirring often. Check temperature before serving. * Put nipples on bottles after heating and shake thoroughly. "Wrist" test before feeding. 	<ul style="list-style-type: none"> * Heat baby food in original jars. * Heat disposable bottles. * Heat bottles with nipples on.
General	<ul style="list-style-type: none"> * Cut baked goods with filling after heating to release steam and avoid burns. * Stir liquid briskly before and after heating to avoid "eruption". * Use deep bowl when cooking liquid or cereal to prevent boilovers. 	<ul style="list-style-type: none"> * Heat or cook in closed glass jars or air tight containers. * Can in the microwave as harmful bacteria may not be destroyed. * Deep fat fry. * Dry wood, gourds, herbs or wet papers.

About Utensils and Coverings

It is not necessary to buy all new cookware. Many pieces already in your kitchen can be used successfully in your new convection microwave oven. The chart below will help you decide what utensils and coverings should be used in each mode.

Utensils and Coverings	Microwave Only	Convection Broil, Slow Cook	High Mix/Roast Low Mix/Bake
Aluminum foil	Yes Small flat pieces of aluminum foil placed smoothly on food can be used to shield areas from cooking or defrosting too quickly. Keep foil at least 1 inch from walls of oven.	Yes For shielding	Yes For shielding
Aluminum containers	Yes Can be used if 3/4 filled with food. Keep 1 inch away from walls and do not cover with foil.	Yes Broil-No cover	Yes Can be used if 3/4 filled with food. Keep 1 inch away from walls and do not cover with foil.
Browning dish	Yes Do not exceed recommended preheating time. Follow manufacturer's directions.	No	No
Glass ceramic (Pyroceram.®)	Yes Excellent	Yes Excellent	Yes Excellent
Glass, heat-resistant	Yes Excellent. Overturned pie plate necessary for popping popcorn.	Yes Excellent	Yes Excellent
Glass, non-heat-resistant	No	No	No
Lids, glass	Yes	Yes Broil-No cover	Yes
Lids, metal	No	Yes Broil-No cover	No
Metal cookware	No	Yes	Yes Do not use metal covering.
Metal, misc: dishes with metallic trim, screws, bands, handles. Metal twist ties	No	No	No
Oven cooking bags	Yes Good for large meats or foods that need tenderizing. DO NOT use metal twist ties.	Yes Broil-No	Yes DO NOT use metal twist ties.
Paper plates	Yes For reheating	No	No
Paper towels	Yes To cover for reheating and cooking. Do not use recycled paper towels which may contain metal filings.	No	No
Paper, ovenable	Yes	Yes For temperatures up to 400°F. Do not use for broiling.	Yes For temperatures up to 400°F.

Utensils and Coverings	Microwave Only	Convection Broil, Slow Cook	High Mix/Roast Low Mix/Bake
Microwave-safe plastic containers	Yes Use for reheating and defrosting. Some microwave-safe plastics are not suitable for cooking foods with high fat and sugar content. Follow manufacturer's directions.	No	No
Plastic, Thermoset®	Yes	Yes Are heat resistant up to 425°F. Do not use for broiling.	Yes
Plastic wrap	Yes Use brands specially marked for microwave use. DO NOT allow plastic wrap to touch food. Vent so steam can escape.	No	No
Pottery, porcelain stoneware	Yes Check manufacturer's recommendation for being microwave safe.	Yes	Yes Must be microwave safe AND ovenable.
Styrofoam	Yes For reheating	No	No
Wax paper	Yes Good covering for cooking and reheating	No	No
Wicker, wood, straw	Yes May be used for short periods of time. Do not use with high fat or high sugar content foods. Could char.	No	No

DISH CHECK. If you wish to check if a dish is safe for microwaving, place the empty dish in the oven and microwave on HIGH for 30 seconds. If the dish becomes very hot, do NOT use it for microwaving.

ACCESSORIES There are many microwave accessories available for purchase. Evaluate carefully before you purchase so that they meet your needs. A microwave-safe thermometer will assist you in determining correct doneness and assure you that foods have been cooked to safe temperatures when using microwave-only cooking. Sharp is not responsible for any damage to the oven when accessories are used.

About Microwave Cooking

- * Arrange food carefully. Place thickest areas toward outside of dish.
- * Watch cooking time. Cook for the shortest amount of time indicated and add more as needed. Foods severely overcooked can smoke or ignite.
- * Cover foods while cooking. Check recipe or cookbook for suggestions: paper towels, wax paper, microwave plastic wrap or a lid. Covers prevent spattering and help foods to cook evenly.
- * Shield with small flat pieces of aluminum foil any thin areas of meat or poultry to prevent overcooking before dense, thick areas are cooked thoroughly.
- * Stir foods from outside to center of dish once or twice during cooking, if possible.
- * Turn foods over once during microwaving to speed cooking of such foods as chicken and hamburgers. Large items like roasts or turkey breasts must be turned over at least once.
- * Rearrange foods like meatballs halfway through cooking both from top to bottom and from the center of the dish to the outside.
- * Add standing time. Remove food from oven and stir, if possible. Cover for standing time which allows the food to finish cooking without overcooking.
- * Check for doneness. Look for signs indicating that cooking temperatures have been reached.

Doneness signs include:

 - Food steams throughout, not just at edge.
 - Center bottom of dish is very hot to the touch.
 - Poultry thigh joints move easily.
 - Meat and poultry show no pinkness.
 - Fish is opaque and flakes easily with a fork.

About Children and the Microwave

Children below the age of 7 should use the microwave oven with a supervising person very near to them. Between the ages of 7 and 12, the supervising person should be in the same room.

The child must be able to reach the oven comfortably; if not, he/she should stand on a sturdy stool.

At no time should anyone be allowed to lean or swing on the oven door.

Children should be taught all safety precautions: use potholders, remove coverings carefully, pay special attention to packages that crisp food because they may be extra hot.

Don't assume that because a child has mastered one cooking skill he/she can cook everything.

Children need to learn that the microwave oven is not a toy. See page 25 for Safety Lock feature.

About Safety

* Check foods to see that they are cooked to the United States Department of Agriculture's recommended temperatures:

- 160°F. for fresh pork, boneless white poultry, fish, seafood, egg dishes and frozen prepared food.
- 165°F. for leftover, ready-to-heat refrigerated, and deli and carry-out "fresh" food.
- 170°F. white meat of poultry.
- 180°F. dark meat of poultry.

To test for doneness, insert a meat thermometer in a thick or dense area away from fat or bone. NEVER leave the thermometer in food during cooking, unless using a microwave thermometer when cooking with only microwave power.

* Always use potholders to prevent burns when handling utensils that are in contact with hot food.

Enough heat from the food can transfer through utensils to cause skin burns.

* Avoid steam burns by directing steam away from the face and hands. Slowly lift the farthest edge of a dish's covering and carefully open popcorn and oven cooking bags away from the face.

* Stay near the oven while it's in use and check cooking progress frequently so that there is no chance of overcooking food.

* NEVER use the cavity for storing cookbooks or other items.

* Select, store and handle food carefully to preserve its high quality and minimize the spread of foodborne bacteria.

* Keep wave guide cover clean. Food residue can cause arcing and/or fires.

* Keep aluminum foil used for shielding at least 1 inch away from walls, ceiling and door.

* Use potholders and be careful when using convection, mix or broil cooking as cabinet, interior and door may be too hot to touch.

* Use care when removing items from the oven so that the utensil, your clothes or accessories do not touch the safety door latches.

PART NAMES

① Ventilation openings. (Rear side)

② Oven door with see-through window.

③ Oven light.

It will light when the door is opened or when oven is in operation.

④ Turntable support.

⑤ Removable turntable.

The turntable will rotate clockwise or counterclockwise.

⑥ Safety door latches.

The oven will not operate unless the door is securely closed.

⑦ Waveguide cover.

⑧ Door open button.

⑨ Auto-Touch control panel.

⑩ Lighted digital display.

⑪ Convection air openings.

⑫ Removable low rack. (Broiling trivet)

⑬ Removable high rack. (Baking rack)

⑭ Turntable motor shaft.

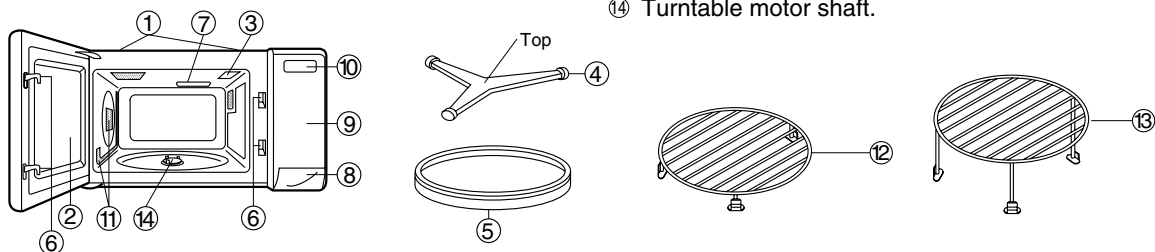

PART NAMES

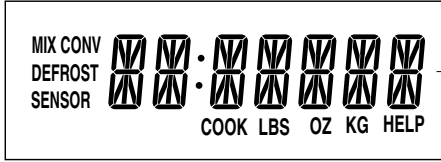

Interactive display
Words will light in the display to indicate features and cooking instructions.

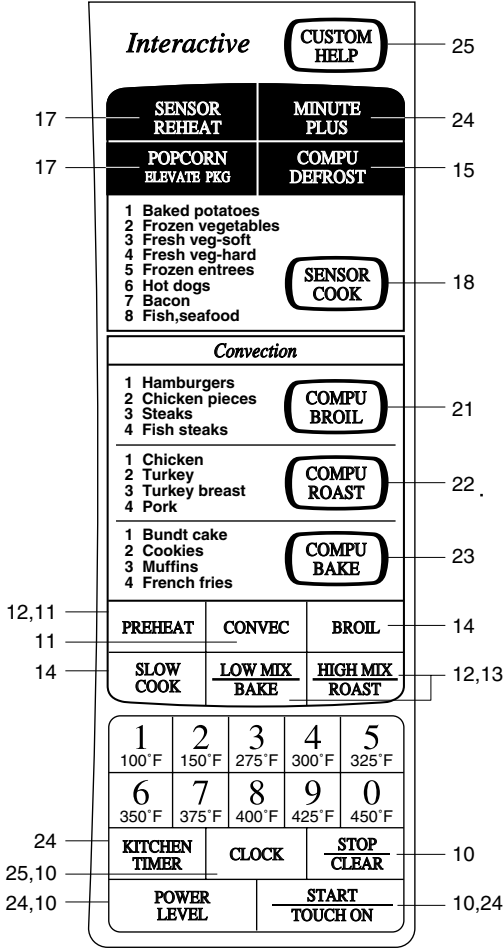

R-930AK, R-930AW

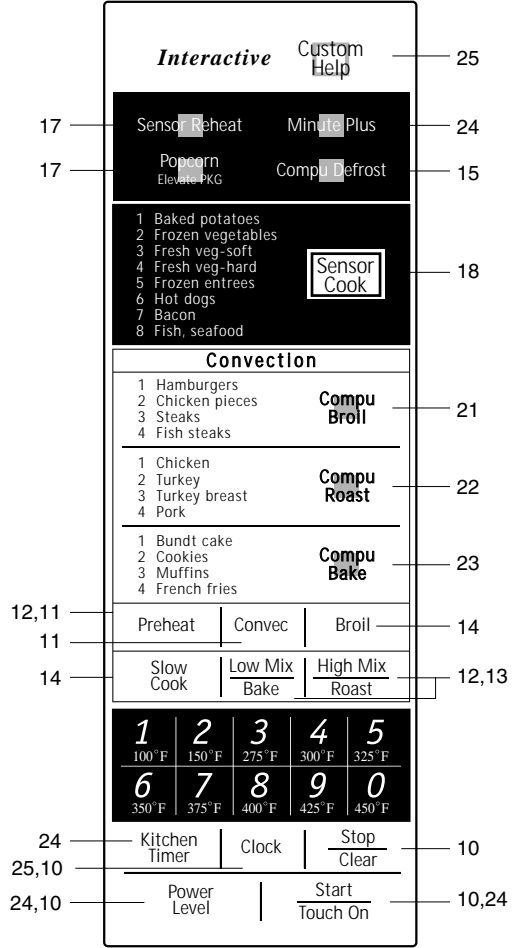

R-930CS

Numbers indicate pages on which there are a feature description and usage information.

ACCESSORIES

The following accessories are designed especially for use in this oven only for convection, mix or broil cooking. **DO NOT USE FOR MICROWAVE ONLY COOKING.** Do not substitute similar types of racks for these specially designed ones.

High rack (Baking rack)—for convection and low mix. —This rack is placed on the turntable for two-level cooking, such as layer cakes, muffins, etc.

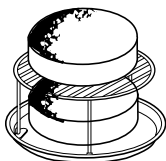

Low rack (Broiling trivet)—for convection, broiling or high mix.

—Place on the turntable and use for roasting or broiling to allow juices to drain away from food.



BEFORE OPERATING

* Before operating your new microwave oven make sure you read and understand this operation manual completely.

* Before the oven can be used, follow these procedures:

- 1) Plug in the oven. Close the door. The display will say **SHARP SIMPLY THE BEST PRESS CLEAR AND PRESS CLOCK**.
- 2) Touch the STOP/CLEAR pad.
 : will appear.
- 3) Touch CLOCK pad.

TO SET THE CLOCK

* Suppose you want to enter the correct time of day 12:30 (A.M. or P.M.):

Procedure		
1.	<input type="text" value="CLOCK"/>	Touch CLOCK pad.
2.	<input type="text" value="1"/> <input type="text" value="2"/> <input type="text" value="3"/> <input type="text" value="O"/>	Enter the correct time of day by touching the numbers in sequence.
3.	<input type="text" value="CLOCK"/>	Touch CLOCK pad again.

This is a 12 hour clock. If you attempt to enter an incorrect clock time, **ERROR** will appear in the display. Touch the STOP/CLEAR pad and re-enter the time.

* If the electrical power supply to your microwave oven should be interrupted, the display will intermittently show **SHARP SIMPLY THE BEST PRESS CLEAR AND PRESS CLOCK** after the power is reinstated. If this occurs during cooking, the program will be erased. The time of day will also be erased. Simply touch STOP/CLEAR pad and reset the clock for the correct time of day.

STOP/CLEAR

Touch the STOP/CLEAR pad to:

1. Erase if you make a mistake during programming.
2. Cancel kitchen timer.
3. Stop the oven temporarily during cooking.
4. Return the time of day to the display.
5. Cancel a program during cooking, touch twice.

MANUAL OPERATION

MICROWAVE COOKING

Time Cooking

Your oven can be programmed for 99 minutes 99 seconds (99.99). Always enter the seconds after the minutes, even if they are both zeros.

* Suppose you want to cook for 5 minutes at 100%:

Procedure		
1.	<input type="text" value="5"/> <input type="text" value="O"/> <input type="text" value="O"/>	Enter cooking time.
2.	<input type="text" value="START TOUCH ON"/>	Touch START pad.

There are eleven preset power levels. Using lower power levels increases the cooking time which is recommended for foods such as cheese, milk and long slow cooking of meats. Consult cookbook or recipes for specific recommendations.

Touch POWER LEVEL Pad Once, then Touch	Approximate Percentage of Power	Common Words for Power Levels
POWER LEVEL	100%	High
9	90%	
8	80%	
7	70%	Medium High
6	60%	
5	50%	Medium
4	40%	
3	30%	Med. Low/Defrost
2	20%	
1	10%	Low
0	0%	

* Suppose you want to defrost for 5 minutes at 30%:

Procedure		
1.	<input type="text" value="5"/> <input type="text" value="O"/> <input type="text" value="O"/>	Enter defrosting time.
2.	<input type="text" value="POWER LEVEL"/> <input type="text" value="3"/>	Enter power level.
3.	<input type="text" value="START TOUCH ON"/>	Touch START pad.

You can program up to 4 automatic cooking sequences. Follow directions on page 24. Note that POWER LEVEL must be entered first when programming multiple sequences.

CONVECTION AND AUTOMATIC MIX COOKING

This section of the Operation Manual gives you specific cooking instructions and procedures. Please consult your Sharp Carousel Convection Microwave Cookbook for helpful hints for convection and combination cooking.

Page numbers followed by the letter c indicate the convection/mix section of the book.

The oven should not be used without the turntable in place, and it should never be restricted so that it cannot rotate. You may remove the turntable when preheating the oven and when preparing food to be cooked directly on the turntable.





Caution: The oven cabinet, cavity, door, turntable, turntable support, racks and dishes will become hot. To PREVENT BURNS, use thick oven gloves when removing the food or turntable from the oven.

Convection Cooking

During convection heating, hot air is circulated throughout the oven cavity to brown and crisp foods quickly and evenly. This oven can be programmed for ten different convection cooking temperatures for up to 99 minutes, 99 seconds.

To Cook with Convection

* Suppose you want to cook at 350°F. for 20 minutes:







Procedure		
1.		Touch CONVEC pad.
2.		Touch temperature pad.
3.		Enter cooking time.
4.		Touch START pad.

NOTE: If you wish to know the programmed oven temperature, simply touch the CONVEC pad. As long as your finger is touching the CONVEC pad, the programmed oven temperature will be displayed.

To Preheat and Cook with Convection

Your oven can be programmed to combine preheating and convection cooking operations. You can preheat to the same temperature as the convection temperature or change to a higher or lower temperature.

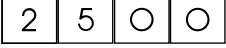
* Suppose you want to preheat to 350° F, and then cook 25 minutes at 375° F. convection:

Procedure		
1.		Touch PREHEAT pad.
2.		Select preheat temperature.
3.		Touch CONVEC pad.
4.		Select cooking temperature.
5.		Enter cooking time.
6.		Touch START pad.
<p>When the oven reaches the programmed temperature, a signal will sound 4 times*. The oven will stop, and directions will be displayed. Follow the indicated message.</p>		
7.	<p>Open the door. Place food in the oven. Close the door.</p>	
		Touch START pad.

* If the oven door is not opened, the oven will automatically hold at the preheat temperature for 30 minutes. After this time has elapsed, an audible signal will sound, and the oven will turn off.

NOTE: 1. To program only preheat, touch the START pad after step 2. Preheating will start. When the oven reaches the programmed temperature, follow the indicated message.
2. To preheat and cook with the same temperature, enter same temperature in steps 2 and 4.

Automatic Mix Cooking

This oven has two pre-programmed settings that make it easy to cook with both convection heat and microwave automatically

	Oven temperature	Microwave power
HIGH MIX/ROAST	300°F	30%
LOW MIX/BAKE	350°F	10%

With the exception of those foods that cook best by convection heating alone, most foods are well suited to mix cooking using either LOW MIX/BAKE or HIGH MIX/ROAST.



The marriage of these two cooking methods produces juicy meats, moist and tender cakes and fine textured breads, all with just the right amount of browning and crispness.

The temperatures can be changed; however, the microwave power cannot.

The oven temperature can be changed from 100°F. to 450°F. To change the temperature, first touch HIGH MIX or LOW MIX, then touch the same pad again. When the display says SELECT TEMP, touch desired temperature pad. Ex: HIGH MIX, HIGH MIX pad, . The mix temperature will change to 375°F automatically.

To Cook with Automatic Mix

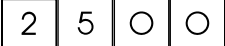





* Suppose you want to bake a cake for 25 minutes on low mix/bake:

Procedure		
1.		Touch LOW MIX/BAKE pad.
2.		Enter cooking time.
3.		Touch START pad.

To Preheat and Cook with Automatic Mix

Your oven can be programmed to combine preheating and automatic mix cooking operations. You can preheat at the same temperature as the preset combination temperature or change it to a different temperature.

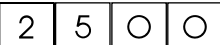
* Suppose you want to preheat to 350°F. and then cook 25 minutes on 325°F. low mix/bake:

Procedure		
1.		Touch PREHEAT pad.
2.		Select preheat temperature.
3.		Touch LOW MIX pad.
4.		Touch LOW MIX pad once more to change the cooking temperature.
5.		Select cooking temperature.
6.		Enter cooking time.
7.		Touch START pad.
When the oven reaches the programmed temperature, signal will sound 4 times*. The oven will stop and directions will be displayed. Follow the indicated message.		
8.	Open the door. Place food in the oven. Close the door.	
		Touch START pad.

* If the oven door is not opened, the oven will automatically hold at the preheat temperature for 30 minutes. After this time has elapsed, an audible signal will sound and the oven will turn off.

NOTE: To program only preheat, touch the START pad after step 2. Preheating will start. When the oven reaches the programmed temperature, follow the indicated message.

Helpful Hints for Convection and Automatic Mix Cooking

Your Sharp Convection Microwave Oven can cook any food perfectly because of the number of ways it can cook: microwave only, automatic mix, convection only or broil. The cookbook that comes with your oven has excellent instructions, guidelines, hints, charts and recipes to help you get the best use of your oven. Consult it often until you are familiar with it. This Operation Manual tells you how to program the oven.

The oven cannot be used without the turntable in place. Never restrict the movement of the turntable.

Convection Cooking:

1. When preheating, the turntable can be left in or removed. When using the high rack for 2 shelf baking in a preheated oven, it is easier to remove the turntable for preheat. Place high rack on turntable along with foods. When preheat is over, open oven door and quickly place turntable, high rack and foods to be baked inside.
2. Do not cover turntable, low rack or high rack with aluminum foil. It interferes with air flow that cooks food.
3. Round pizza pans are excellent cooking utensils for many convection-only items. Choose pans that do not have extended handles.
4. Using a preheated low rack can give a grilled appearance to steaks, hot dogs etc.

Automatic Mix Cooking:

1. Meats are best when roasted directly on the low rack. A dish can be placed below the meat if gravy is to be made from the drippings.
2. Less tender cuts of meat can be roasted and tenderized using oven cooking bags.
3. When baking, check for doneness after time has elapsed. If not completely done, let stand in oven a few minutes to complete cooking.

NOTE:

During mix baking some metal baking utensils may cause arcing when they come in contact with the turntable, oven walls or accessory racks. Arcing is a discharge of electricity that occurs when microwaves come in contact with metal.

If arcing occurs, place a heat resistant dish (Pyrex[®] pie plate, glass pizza dish or dinner plate) between the pan and the turntable or rack. If arcing occurs with other metal baking utensils, discontinue their use for mix cooking.

BROIL COOKING

Preheating is automatic when the BROIL setting is used. Only actual cooking time is entered; the oven signals when it is preheated to 450°F. Oven temperature cannot be changed. Use BROIL setting for steaks, chops, chicken pieces and many other foods. See Convection Broiling Chart in cookbook.

* Suppose you want to broil a steak for 15 minutes:

Procedure	
1.	<div style="display: flex; align-items: center; gap: 10px;"> <div style="border: 1px solid black; padding: 5px; text-align: center;">BROIL</div> <div>Touch BROIL pad.</div> </div>
2.	<div style="display: flex; align-items: center; gap: 10px;"> <div style="display: flex; gap: 5px;"> <div style="border: 1px solid black; padding: 2px 5px;">1</div> <div style="border: 1px solid black; padding: 2px 5px;">5</div> <div style="border: 1px solid black; padding: 2px 5px;">○</div> <div style="border: 1px solid black; padding: 2px 5px;">○</div> </div> <div>Enter cooking time.</div> </div>
3.	<div style="display: flex; align-items: center; gap: 10px;"> <div style="border: 1px solid black; padding: 5px; text-align: center;"> START <hr style="width: 50%; margin: 0 auto;"/> TOUCH ON </div> <div>Touch START pad. No food in oven.</div> </div>
<p>When the oven reaches the programmed temperature, a signal will sound 4 times*.</p>	
4.	<div style="display: flex; align-items: center; gap: 10px;"> <div>Open the door. Place food in oven. Close the door.</div> <div style="border: 1px solid black; padding: 5px; text-align: center;"> START <hr style="width: 50%; margin: 0 auto;"/> TOUCH ON </div> <div>Touch START pad.</div> </div>

* If the oven door is not opened, the oven will automatically hold at the preheat temperature for 30 minutes. After this time has elapsed, an audible signal will sound and the oven will turn off.

- NOTE:
1. Preheating for broil may take from 7 to 10 minutes depending on temperature of room and available power.
 2. Although time is usually set for the maximum broiling time, always check food at the minimum time recommended in the chart of cookbook. This will eliminate the need to completely reprogram the oven if additional cooking time is needed. Simply close the oven door and touch START to continue.
 3. Should you need more broiling time, reprogram within 1 minute of the end to eliminate preheating.

Caution: The oven cabinet, cavity, door, turntable, turntable support, racks and dishes will become hot. To PREVENT BURNS, use thick oven gloves when removing the food or turntable from the oven.

SLOW COOK

Slow Cook is preset at 300°F for 4 hours. The temperature can be changed to below 300°F. The cooking time cannot be changed. This feature can be used for foods such as baked beans or marinated chuck steak.

* Suppose you want to change oven temperature from 300°F to 275°F:

Procedure	
1.	<div style="display: flex; align-items: center; gap: 10px;"> <div style="border: 1px solid black; padding: 5px; text-align: center;">SLOW COOK</div> <div>Touch SLOW COOK pad.</div> </div>
2.	<div style="display: flex; align-items: center; gap: 10px;"> <div style="border: 1px solid black; padding: 5px; text-align: center;">SLOW COOK</div> <div>Touch SLOW COOK pad once more if you want to change the temperature from 300°F.</div> </div>
3.	<div style="display: flex; align-items: center; gap: 10px;"> <div style="border: 1px solid black; padding: 5px; text-align: center;"> 3 275°F </div> <div>Select the temperature.</div> </div>
4.	<div style="display: flex; align-items: center; gap: 10px;"> <div style="border: 1px solid black; padding: 5px; text-align: center;"> START <hr style="width: 50%; margin: 0 auto;"/> TOUCH ON </div> <div>Touch START pad.</div> </div>





NOTE: If you do not change the temperature, omit steps 2 and 3.

SPECIAL FEATURES

COMPU DEFROST

CompuDefrost automatically defrosts foods shown in the chart below.

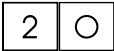
* Suppose you want to defrost a 2.0 pound steak:

Procedure	
1.	 Touch COMPU DEFROST pad once.
2.	 x2 Select desired food by touching COMPU DEFROST pad until the display shows the food name. (Ex. touch twice for steak)
3.	 Enter weight by touching the number pads. (ex. 2.0 lbs.)
4.	 Touch START pad.
The oven will stop and directions will be displayed. Follow the indicated message.	

5. After the 1st stage, open the door. Turn steak over and shield any warm portions. Close the door.

 Touch START pad.

6. After the 2nd stage, open the door. Shield any warm portions. Close the door.

 Touch START pad.

7. After defrost cycle ends, cover and let stand as indicated in chart below.

NOTE:

- If you attempt to enter more or less than the allowed amount as indicated in chart below, an error message will appear in the display.
- CompuDefrost can be programmed with More or Less Time Adjustment. Touch the POWER LEVEL pad once or twice after selecting the amount. See page 24.
- To defrost other foods or foods above or below the weights allowed on COMPU DEFROST CHART, use time and 30% power. See Manual Defrost on page 16.

COMPU DEFROST CHART

Food	Amount	Procedure
1. Ground meat	0.5–3.0 lbs. (0.3–1.3 kg.)	Remove any thawed pieces after each stage. Let stand, covered, 5–10 minutes.
2. Steaks (Chops) (Fish)	0.5–4.0 lbs. (0.3–1.8 kg.)	After each stage of defrost cycle, rearrange and if there are warm or thawed portions, shield with small flat pieces of aluminum foil. Remove any meat or fish that is nearly defrosted. Let stand, covered, 10–20 minutes.
3. Chicken pieces	0.5–3.0 lbs. (0.3–1.3 kg.)	After each stage of defrost cycle, if there are warm or thawed portions, rearrange or remove. Let stand, covered, 10–20 minutes.

NOTE: Check foods when oven signals. After final stage, small sections may still be icy. Let stand to continue thawing. Do not defrost until all ice crystals are thawed. Shielding prevents cooking from occurring before the center of the food is defrosted. Use small smooth strips of aluminum foil to cover edges and thinner sections of the food.

MANUAL DEFROST

If the food that you wish to defrost is not listed on the COMPU DEFROST CHART or is above or below the limits in the "Amount" column on the COMPU DEFROST CHART, you need to defrost manually.

You can defrost any frozen food, either raw or previously cooked, by using Power Level 3. Follow the exact 3-step procedure found under Time Cooking on page 10. Estimate defrosting time and press 3 for 30% when you select the power level.

For either raw or previously cooked frozen food the rule of thumb is approximately 5 minutes per pound. For example, defrost 5 minutes for 1 pound of frozen spaghetti sauce.

Always stop the oven periodically to remove or separate the portions that are defrosted. If food is not defrosted at the end of the estimated defrosting time, program the oven in 1 minute increments on Power Level 3 until totally defrosted.

When using plastic containers from the freezer, defrost only long enough to remove from the plastic in order to place in a microwave-safe dish.

SENSOR COOKING

Sharp's Sensor is a semi-conductor device that detects the vapor (moisture and humidity) emitted from food as it heats. The sensor adjusts the cooking times and power level for various foods and quantities.

Using Sensor Settings:

1. After oven is plugged in, wait 2 minutes before using sensor settings.
2. Be sure the exterior of the cooking container and the interior of the oven are dry. Wipe off any moisture with a dry cloth or paper towel.
3. Sensor Reheat and Popcorn can only be entered within 1 minute after cooking, opening and closing the door or touching the STOP/CLEAR pad.
4. During the first part of sensor cooking, the food name will appear on the display. Do not open the oven door or touch STOP/CLEAR during this part of the cooking cycle. The measurement of vapor will be interrupted. If this occurs, an error message will appear. To continue cooking, touch the STOP/CLEAR pad and select cooking time and variable power.

When the sensor detects the vapor emitted from the food, remainder of cooking time will appear. Door may be opened when remaining cooking time appears on the display. At this time, you may stir or season food, as desired.

5. Check food for temperature after cooking. If additional time is needed, continue to cook with variable power and time.
6. If the sensor does not detect vapor properly when popping popcorn, the oven will turn off, and the correct time of day will be displayed. If the sensor does not detect vapor properly when using sensor reheat, **ERROR** will be displayed, and the oven will turn off.
7. Any Sensor Cooking mode can be programmed with More or Less Time Adjustment. See page 24.
8. Each food has a cooking hint. Touch CUSTOM HELP when the HELP indicator is lighted in the display.

Selecting Foods:

1. The sensor works with foods at normal storage temperature. For example, food for dinner plate reheat would be at refrigerator temperature and popcorn at room temperature.
2. Foods weighing less than 3 ounces should be reheated by time and variable power.

Covering Foods:

Some foods work best when covered. Use the cover recommended in the chart for these foods.

1. Casserole lid
2. Plastic wrap: Use plastic wrap recommended for microwave cooking. Cover dish loosely; allow approximately 1/2 inch to remain uncovered to allow steam to escape. Plastic wrap should not touch food.
3. Wax paper: Cover dish completely; fold excess wrap under dish to secure. If dish is wider than paper, overlap two pieces at least one inch to cover.

Be careful when removing any covering to allow steam to escape away from you.

Instant Sensors

Your oven has Instant Sensor Popcorn and Instant Sensor Reheat. To use either, simply touch the chosen pad. The oven will start automatically.

-Sensor Reheat

You can reheat many foods by touching just one pad. You don't need to calculate reheating time or power level.

* Suppose you want to heat prepared chili:

Procedure	
1.	<div style="border: 1px solid black; padding: 5px; display: inline-block; text-align: center;"> SENSOR REHEAT </div> Touch SENSOR REHEAT pad.
When sensor detects the vapor emitted from the food, remainder of reheating time will appear.	

-Sensor Popcorn

*Suppose you want to pop a 3.5 oz. bag of popcorn:

Procedure	
1. Place bag on overturned 9" glass pie plate.	
2.	<div style="border: 1px solid black; padding: 5px; display: inline-block; text-align: center;"> POPCORN ELEVATE PKG </div> Touch POPCORN pad once.

This sensor setting works well with most brands of microwave popcorn. You may wish to try several and choose your favorite. Pop only one bag at a time. Unfold the bag and place in oven according to directions.



Use an overturned 9 or 10 inch oven proof glass pie plate on top of the turntable when popping bagged microwave popcorn.

INSTANT SENSOR CHART

Food	Amount	Procedure
Sensor Reheat	4-36 oz.	Place in dish or casserole slightly larger than amount to reheated.
Leftovers such as rice, potatoes, vegetables, casserole	(0.12 - 1.0 kg)	Flatten, if possible. Cover with lid, plastic wrap or wax paper. Use covers such as plastic wrap or lids with larger quantities of more dense foods such as stews.
Soups	1-4 cups	After reheating, stir well, if possible. Foods should be very hot. If not, continue to heat with variable power and time. After stirring, recover and allow to stand 2 to 3 minutes.
Canned entrees and vegetables	4-36 oz.	Use Less Time Adjustment by touching POWER LEVEL pad twice for small quantities of canned vegetables.
Popcorn	Only 1 package at a time	Use only popcorn packaged for microwave oven use. Try several brands to decide which you like best. Do not try to pop unpopped kernels. More/Less Time Adjustment can be used to provide adjustment needed for older popcorn or individual tastes.
	3.0-3.5 oz. bag (Regular size)	Touch POPCORN pad once. This setting works well with most 3.0-3.5 oz bags of microwave popcorn.
	1.5-1.75 oz. bag (Snack size)	Touch POPCORN pad twice within 2 seconds for snack size bags. Do not try to pop unpopped kernels.

SENSOR COOK

*Suppose you want to cook a baked potato:

Procedure		
1.		Touch SENSOR COOK pad.
2.		Select desired sensor setting. Touch  to cook baked potatoes.

3.		Touch START pad. When sensor detects the vapor emitted from the food, the remainder of cooking time will appear.
----	---	--

SENSOR COOK CHART

Food	Amount	Procedure
1. Baked potatoes	1 - 8 medium	Pierce. Place on paper-towel-lined turntable. After cooking, remove from oven, wrap in aluminum foil and let stand 5 to 10 minutes.
2. Frozen vegetables	1 - 8 cups	Cover with lid or plastic wrap. After cooking, stir and let stand 3 minutes, covered.
3. Fresh vegetables, soft		Wash and place in casserole. Add no water if vegetables have just been washed. Cover with lid for tender vegetables. Use plastic wrap for tender-crisp vegetables. Stir before standing if possible. After cooking, let stand, covered, 2-5 minutes.
Broccoli	1/4 - 2 lbs.	
Brussels sprouts	1/4 - 2 lbs.	
Cabbage	1/4 - 2 lbs.	
Cauliflower (flowerets)	1/4 - 2 lbs.	
Cauliflower (whole)	1 medium	
Spinach	1/4 - 1 lbs.	
Zucchini	1/4 - 2 lbs.	
Baked apples	2 - 4 medium (0.2 - 0.9kg)	
4. Fresh vegetables, hard		Place in casserole. Add 1-4 tbsp. water. Cover with lid for tender vegetables. Use plastic wrap cover for tender-crisp vegetables. Stir before standing, if possible. After cooking, let stand, covered, 2-5 minutes.
Carrots, sliced	1/4 - 1 1/2 lbs.	
Corn on cob	2 - 4 pcs.	
Green beans	1/4 - 1 1/2 lbs.	
Winter squash, diced	1/4 - 1 1/2 lbs.	
halves	1 - 2 (0.2 - 0.6kg)	
5. Frozen entrees	6 - 17 oz. (0.17 - 0.48kg)	Use for frozen convenience foods. It will give satisfactory results for most brands. You may wish to try several and choose your favorite. Remove package from outer wrapping and follow package directions for covering. After cooking, let stand, covered, for 1 to 3 minutes.
6. Hot dogs	1 - 4 servings	Place hot dog in bun and wrap in paper towel or paper napkin.
7. Bacon	2 - 6 slices	Place bacon on paper plate, lined with paper towel. Bacon should not extend over the rim of plate. Cover with paper towel. Put another paper plate upside down on turntable. Place plate of bacon on top of overturned plate.
8. Fish, seafood	0.25 - 2.0 lbs. (0.2 - 0.9kg)	Arrange in ring around shallow glass dish (roll fillet with edges underneath). Cover with plastic wrap. After cooking, let stand, covered, 3 minutes.

Sensor Cook Recipes

Cranberry Fluff

- | | |
|--|--|
| 2 cups fresh cranberries | $\frac{1}{2}$ pint whipping cream, whipped or |
| 1 cup water | 1 package (8 ounces) non-dairy whipped topping |
| $\frac{3}{4}$ cup sugar | Makes 6 to 8 servings |
| 1 package (3 ounces) orange-flavored gelatin | |

1. Combine cranberries, water and sugar in a 2-quart casserole. Cover with wax paper. Microwave using Sensor Reheat, Less. Drain cranberries and reserve liquid.
2. Add enough hot water to reserved liquid to make 2 cups. Stir the gelatin into hot liquid until it dissolves. Cover with wax paper. Microwave using Sensor Reheat, Less.
3. Add berries and cool. Refrigerate until thickened. Fold whipped cream into cooled cranberry mixture. Spoon into serving dishes and garnish with extra whipped cream. Refrigerate until ready to serve.

Curry Vegetable Chowder

- | | |
|--|-------------------------------------|
| 6 slices bacon | $\frac{3}{4}$ teaspoon salt |
| 1 can (10 $\frac{3}{4}$ ounces) chicken broth | $\frac{1}{2}$ teaspoon curry powder |
| 3 medium potatoes, finely diced (about 2 cups) | $\frac{1}{8}$ teaspoon pepper |
| 2 carrots, shredded (about 1 cup) | 1 can (12 ounces) evaporated milk |
| 1 small onion, chopped (about $\frac{1}{2}$ cup) | 2 tablespoons chopped fresh parsley |
| | Makes 4 servings |

1. Layer 2 paper towels on a microwave safe paper plate. Arrange bacon on the towels. Cover with another paper towel. Place an overturned paper plate on turntable and put plate of bacon on top of it. Microwave using Sensor Cook for Bacon. Crumble and reserve bacon.
2. Combine chicken broth, vegetables and seasonings in 4-quart casserole. Cover with vented plastic wrap. Microwave using Sensor Cook for Baked Potatoes. Vegetables should be tender.
3. Stir in evaporated milk. Recover with vented plastic wrap. Microwave using Sensor Reheat, Less. Stir in parsley. Let stand covered, 5 minutes.
4. Top each serving with crumbled bacon.

Flounder Fillet with Vegetables

- | | |
|-----------------------------------|--|
| $\frac{1}{2}$ green pepper, diced | 1 pound flounder fillet, fresh or frozen, thawed |
| 1 small onion | $\frac{1}{8}$ teaspoon pepper |
| 1 medium potato, peeled and diced | $\frac{1}{8}$ teaspoon paprika |
| 1 clove garlic, minced | $\frac{1}{4}$ teaspoon salt |
| 2 tablespoons margarine or butter | $\frac{1}{4}$ teaspoon thyme leaves |
| 1 medium tomato, chopped | parsley flakes |
| | Makes 4 servings |

1. Combine green pepper, onion, potato, garlic and margarine in 2-cup measuring cup. Cover with vented plastic wrap. Microwave using Sensor Cook for Fresh Vegetables, Soft. Stir in tomato.
2. Arrange fish in a ring around the outside of a 12-inch round glass utility dish. Pour vegetables over fish. Sprinkle with pepper, paprika, salt and thyme. Cover well with vented plastic wrap. Microwave using Sensor Cook for Fish and Seafood. Let stand 2 minutes. Top with parsley and serve.

Glazed Apple Slices

- | | |
|--------------------------------------|--|
| $\frac{1}{4}$ cup packed brown sugar | $\frac{3}{4}$ cup orange juice |
| 3 tablespoons margarine or butter | 1 tablespoon cornstarch |
| 2 tablespoons apricot preserves | 4 baking apples (about 1 $\frac{1}{2}$ pounds), peeled and sliced into 8 pieces each |
| $\frac{1}{2}$ teaspoon ground nutmeg | 3 tablespoons chopped green pistachios |
| $\frac{1}{4}$ teaspoon salt | Makes 6 to 8 servings |
| $\frac{1}{2}$ cup sugar | |

1. Combine brown sugar, margarine and apricot preserves in a small bowl. Microwave at HIGH (100%) until margarine melts and preserves soften, 45 seconds to 1 minutes. Stir in nutmeg, salt, sugar, orange juice and cornstarch. Microwave at HIGH (100%) until thickened, 4 to 6 minutes, stirring several times.
2. Arrange apple slices in a large microwave serving dish. Spread hot sauce over apples. Cover well with vented plastic wrap. Microwave using Sensor Cook for Fresh Vegetables, Soft. Allow to cool 5 minutes before serving.
3. Sprinkle with pistachios. Serve alone or over vanilla ice cream or sponge cake.

Mexican Seasoned Potatoes

- | | |
|--|---------------------------------------|
| 4 medium baking potatoes (8 ounces each) | $\frac{1}{2}$ teaspoon oregano leaves |
| $\frac{1}{4}$ cup olive oil | $\frac{1}{4}$ teaspoon ground cumin |
| 1 tablespoon instant minced onion | $\frac{1}{2}$ teaspoon salt |
| $\frac{1}{2}$ teaspoon chili powder | |

Makes 6 to 8 servings

1. Cut each potato lengthwise into 4 equal wedges. Place potato wedges into 10-inch square casserole. Toss potatoes with oil to coat well.
2. In small bowl, combine remaining ingredients. Sprinkle over potatoes.
3. Cover potatoes with wax paper. Microwave using Sensor Cook for Baked Potatoes. Rearrange potatoes when time appears on display. Let stand covered 5 minutes.

Microwaved Fresh Pumpkin

- 1 Pie Pumpkin or Sugar Pumpkin

1. Wash and cut pumpkin into quarters. Remove seeds and strings. Place in a glass pie plate. Cover well with vented plastic wrap.
2. Microwave using Sensor Cook for Fresh Vegetables, Hard. Allow to stand covered 5 minutes.
3. Scrape the pulp from the shell. Strain off excess liquid from cooked pumpkin. Place pumpkin into food processor or blender and process until smooth. Use in your favorite recipes.

Shrimp Scampi

- | | |
|---------------------------------------|--|
| $\frac{1}{2}$ cup margarine or butter | $\frac{1}{2}$ teaspoon salt |
| 1 tablespoon snipped fresh parsley | 1 pound large raw shrimp, shelled and deveined |
| 2 tablespoons lemon juice | paprika |
| 1 large clove garlic, minced | |

Makes 4 servings

1. Place margarine in 2-cup measuring cup. Microwave at HIGH (100%) until melted, 1 to 1 $\frac{1}{2}$ minutes. Stir in parsley, lemon juice, garlic and salt.
2. Arrange shrimp in a large glass pie plate. Pour seasoned butter over shrimp. Cover well with vented plastic wrap. Microwave using Sensor Cook for Fish and Seafood. Shrimp should be pink and opaque.
3. Sprinkle with paprika and serve over hot cooked rice.

Spiced Carrots

- | | |
|---|---|
| 3 cups sliced carrots, $\frac{1}{4}$ inch thick | 2 teaspoons vinegar |
| $\frac{1}{2}$ cup chopped green pepper, 1 inch cubes | 1 teaspoon soy sauce |
| $\frac{1}{4}$ cup finely chopped onion | $\frac{1}{2}$ teaspoon salt |
| 3 tablespoons water | $\frac{1}{2}$ teaspoon prepared mustard |
| 1 can (7 $\frac{3}{4}$ ounces) semi-condensed tomato soup | $\frac{1}{8}$ teaspoon pepper |
| $\frac{1}{2}$ cup sugar | |

Makes 6 to 8 servings

1. In a 1 $\frac{1}{2}$ -quart casserole, combine carrots, green pepper, onion and water. Cover with lid. Microwave using Sensor Cook for Fresh Vegetables, Hard. Carrots should be tender crisp. Drain.
2. Stir in remaining ingredients. Cover and microwave using Sensor Reheat.

Spaghetti Squash

- | | |
|--|------------------------------|
| 1 spaghetti squash | |
| Option A | Option B |
| 3 tablespoons butter, melted | 3 tablespoons butter, melted |
| $\frac{1}{4}$ cup grated Parmesan cheese | 1 to 2 tablespoons honey |
| 2 tablespoons chopped parsley | |

1. Prick squash deeply several times with knife or carving fork.
2. Place squash on paper towel on turntable. Touch Sensor Cook for Vegetables, Hard. When oven sounds, remove squash and let stand 10 minutes.
3. While squash is standing, mix together ingredients for Option A or B. Cut squash in half and remove seeds. Unwind squash with fork into spaghetti-like strands.
4. Toss squash with desired mixture. Serve immediately.

COMPU BROIL/ROAST/BAKE





This section of the operation manual offers instructions for preparing 12 popular foods using CompuBroil, CompuRoast and CompuBake.

After selecting the desired feature, follow the directions indicated in the display.

CompuBroil

CompuBroil automatically broils hamburgers, chicken pieces, steaks and fish steaks.



*Suppose you want to broil 2 hamburgers:

Procedure		
1.		Touch COMPU BROIL pad.
2.		Select desired setting. (Ex: for hamburgers, touch  .)
3.		Touch number pad to enter quantity. (Ex:  .) Follow information in display for cooking information.

For well done or rare burgers, touch POWER LEVEL pad to select More for well done or Less for rare. See More/Less Time Adjustment on page 24.

For helpful hints, simply touch CUSTOM HELP anytime HELP is lighted in the display.

Caution: The oven cabinet, cavity, door, turntable, turntable support, racks and dishes will become hot. To PREVENT BURNS, use thick oven gloves when removing the food or turntable from the oven.

4.		Touch START pad.
After broil preheat cycle ends, the oven will stop and directions will be displayed. Follow the indicated message. Open the door and place hamburgers into oven. Close the door.		
5.		Touch START pad.

NOTE:

1. CompuBroil can be programmed with More/Less Time Adjustment. See page 24.
2. If you attempt to enter more or less than the allowed amount as indicated in chart below, an error message will appear in the display.
3. To broil other foods or foods above or below the weight or number allowed on COMPU BROIL CHART follow instructions in the Sharp Carousel Convection Microwave Cookbook. See Convection Broiling Chart.







COMPU BROIL CHART

Setting	Food	Amount	Rack	Procedure
1.	Hamburgers	1 - 8 pieces 1/4 lb. each	Low	Use this setting to broil hamburger patties. Place on low rack.
2.	Chicken pieces	0.5 - 3.5 lbs. (0.3-1.5kg)	Low	Arrange pieces on low rack. After cooking, let stand, 3-5 minutes. Dark meat should be 180°F., and white meat should be 170°F.
3.	Steaks	0.5 - 2.0 lbs. (0.3-0.9kg)	Low	Use this setting to broil steaks from 3/4" to 1" thick. Individual boneless steaks broil evenly. Place steak on low rack. For well done, touch POWER LEVEL once; for rare, touch POWER LEVEL twice.
4.	Fish steaks	0.5 - 2.0 lbs. (0.3-0.9kg)	Low	Use this setting to broil fish steak which is 3/4" to 1" thick. Place on low rack.

CompuRoast

CompuRoast automatically roasts chicken, turkey, turkey breast or pork.

*Suppose you want to roast a 2.5 pound chicken:

Procedure		
1.		Touch COMPU ROAST pad.
2.		Select desired setting. (Ex: for chicken, touch  .)
3.	 	Touch number pads to enter weight. (Ex: 2.5 lbs.)
4.		Touch START/TOUCH ON pad
After COMPU ROAST cycle ends, a long tone will sound. Follow the indicated message.		

NOTE:

1. CompuRoast can be programmed with More/Less Time Adjustment. See page 24.
2. If you attempt to enter more or less than the allowed weight as indicated in chart below, an error message will appear in the display.
3. To roast other food or foods above or below the weights allowed on COMPU ROAST CHART, check the Sharp Carousel Convection Microwave Cookbook Combination Roasting Chart.





COMPU ROAST CHART

Setting	Food	Amount	Rack	Procedure
1.	Chicken	2.5 - 7.5 lbs. (1.2 - 3.4 kg.)	Low	After the cycle ends, cover with foil and let stand for 5 - 10 minutes.
2.	Turkey	6.5 - 16.0 lbs. (3.0 - 7.2 kg.)	Low	Season, as desired. Place on low rack. After the cycle ends, cover with foil and let stand 10 minutes. Internal temperature of white meat should be 170°F. and of dark meat, 180°F.
3.	Turkey breast	3.0 - 6.0 lbs. (1.4 - 2.7 kg.)	Low	Season, as desired. Place on low rack. After the cycle ends, cover with foil and let stand 10 minutes. Internal temperature of white meat should be 170°F.
4.	Pork	2.0 - 3.5 lbs. (0.9 - 1.5kg.)	Low	Boneless pork loin is recommended because it cooks evenly. Place on a low rack. After cooking, remove from oven, cover with foil and allow to stand 5 - 10 minutes. Internal temperature should be 160°F.

CompuBake

CompuBake automatically bakes cakes, brownies, muffins and French fries.

*Suppose you want to bake a bundt cake:

Procedure		
1.		Touch COMPU BAKE pad.
2.		Select desired setting. (Ex: for bundt cake, touch )
3.		Touch START pad.

NOTE:

1. CompuBake can be programmed with More/Less Time Adjustment. See page 24.
2. To bake other foods, see the Sharp Carousel Convection Microwave Cookbook's baking section.

COMPU BAKE CHART

Setting	Food	Pan/Qty	Rack	Procedure
1.	Bundt cake	1 cake	No rack	Ideal for packaged cake mix or your own recipe. Prepare according to package or recipe directions and place in a greased and floured bundt pan. Place pan in oven. Cool before frosting and serving.
2.	Cookies	1 or 2 pizza pans	1 pizza pan No rack 2 pizza pans High	Ideal for refrigerated cookie dough. Prepare according to package or recipe directions and place on a greased and floured 12" pizza pan. Cookies should be approximately 1/3 inch thick and 2 inches in diameter for best results. After the preheat is over, place pan in oven. Cool before serving.
3.	Muffins	6-12 cups 1 or 2 muffin pans	1 pan No rack 2 pans High	Ideal for packaged muffin mix or your own recipe for 6-12 medium size muffins. Prepare according to package or recipe directions and place in muffin pan. After the preheat is over, place pan in oven.
4.	French fries	3 to 24 oz. (0.09-0.68kg) 1 or 2 pizza pans For more than 12 oz. use 2 pans	1 pizza pan No rack 2 pizza pans High	Use frozen prepared French fries. No preheat is required for the French fries baking procedure. Place French fries on pizza pan. For shoestring potatoes, touch POWER LEVEL pad twice to enter less time before touching START pad.





OTHER CONVENIENT FEATURES

MULTIPLE SEQUENCE COOKING

The oven can be programmed for up to 4 automatic cooking sequences for the microwave mode and 2 automatic cooking sequences with preheat for convection/mix mode, switching from one power level setting to another automatically.

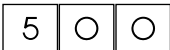
Sometimes cooking directions tell you to start on one power level and then change to a different power level. Your oven can do this automatically.

* Suppose you want to cook roast beef for 5 minutes at 100% and then continue to cook for 30 minutes at 50%:

Procedure		
1.	 x 2 	First touch POWER LEVEL pad twice for 100% power. Then enter cooking time.
2.	 	Touch POWER LEVEL pad. Touch number pad 5 for 50% power. Then enter second cooking time.
3.		Touch START pad.

NOTE: 1. If POWER LEVEL pad is touched twice, **HIGH** will be displayed.

2. If you wish to know power level, simply touch the POWER LEVEL pad. As long as your finger is touching the POWER LEVEL pad, the power level will be displayed.

MORE OR LESS TIME ADJUSTMENT

More



Should you discover that you like any of the INSTANT SENSOR, SENSOR COOK, COMPU DEFROST, COMPU BROIL, COMPU ROAST or COMPU BAKE settings slightly **more** done, touch the POWER LEVEL pad **once** after touching your choice of pads.

Less

Should you discover that you like any of the INSTANT SENSOR, SENSOR COOK, COMPU DEFROST, COMPU BROIL, COMPU ROAST or COMPU BAKE settings slightly **less** done, touch the POWER LEVEL pad **twice** after touching your choice of pads.

KITCHEN TIMER

* Suppose you want to time a 3 minute long distance phone call.

Procedure		
1.		Touch KITCHEN TIMER pad.
2.		Enter time.
3.		Touch START pad.

MINUTE PLUS

Minute Plus allows you to cook for a minute at 100% by simply touching the MINUTE PLUS pad. You can also extend cooking time in multiples of 1 minute by repeatedly touching the MINUTE PLUS pad during manual cooking.

* Suppose you want to heat a cup of soup for one minute:

Procedure		
1.		Touch MINUTE PLUS pad.

NOTE: 1. To use Minute Plus, touch pad within 1 minute after cooking, closing the door, touching the STOP/CLEAR pad or during cooking.

2. Minute Plus cannot be used with SPECIAL FEATURES.

TOUCH ON

Touch On allows you to cook at 100% power by touching the START/TOUCH ON continuously. Touch On is ideal for melting cheese, bringing milk to just below boiling etc.

The maximum cooking time is 3 minutes.

* Suppose you want to melt cheese on a piece of toast:

Procedure		
1.		Continuously touch the START/TOUCH ON pad. The cooking time will begin counting up.
2.	When the cheese is melted to desired degree, remove finger from START/TOUCH ON pad. Oven stops immediately.	

NOTE: 1. Note time it takes for frequently used foods and program that time in the future.

2. To use Touch On, touch pad within 1 minute after cooking, opening and closing the door or touching the STOP/CLEAR pad.

3. Touch On can only be used 3 times in a row. If more times are needed, open and close door or touch STOP/CLEAR.

DEMONSTRATION MODE

To demonstrate, touch **CLOCK**, [0] and then touch **START** and hold for 3 seconds. **DEMO ON** will appear in the display. Cooking operations and specific special features can now be demonstrated with no power in the oven. For example, touch **MINUTE PLUS** and the display will show [1.00] and count down quickly to **END**.

To cancel, touch **CLOCK**, then [0] and **STOP/CLEAR**.

CUSTOM HELP

CUSTOM HELP provides 6 features which make using your oven easy because specific instructions are provided in the Interactive Display.

- Safety Lock

The **Safety Lock** prevents unwanted oven operation such as by small children.

The oven can be set so that the control panel is deactivated or locked. To set, touch **CUSTOM HELP**, the number [1] and **START**. Should a pad be touched, **LOCK** will appear in the display.

To cancel, touch **CUSTOM HELP**, the number [1] and **STOP/CLEAR**.

- Audible Signal Elimination

If you wish to have the oven operate with no audible signals, touch **CUSTOM HELP**, the number [2] and **STOP/CLEAR**.

To cancel and restore the audible signal, touch **CUSTOM HELP**, the number [2] and **START**.

- Auto Start

If you wish to program your oven to begin cooking automatically at a designated time of day, follow this procedure:

* Suppose you want to start cooking a stew for 20 minutes on 50% at 4:30. Before setting, check to make sure the clock is showing the correct time of day.

Procedure		
1.	CUSTOM HELP	Touch CUSTOM HELP .
2.	[3]	Touch the number [3] to select the Auto Start .
3.	[4] [3] [○]	Enter the start time.

4.	CLOCK	Touch CLOCK pad.
5.	POWER LEVEL [5] [2] [○] [○] [○]	Enter cooking program.
6.	START TOUCH ON	Touch START pad. The chosen Auto Start time will appear in the display.

- NOTE:**
1. **Auto Start** can be used for manual cooking **Compu Broil/Roast/Bake**, if clock is set.
 2. If the oven door is opened after programming **Auto Start**, it is necessary to touch the **START** pad for **Auto Start** time to appear in the readout so that the oven will automatically begin programmed cooking at the chosen **Auto Start** time.
 3. Be sure to choose foods that can be left in the oven safely until the **Auto Start** time. Acorn or butternut squash are often a good choice.
 4. If you wish to know the time of day, simply touch the **CLOCK** pad. As long as your finger is touching the **CLOCK** pad, the time of day will be displayed.

- Language Selection

The oven comes set for English language. To change, touch **CUSTOM HELP** and the number [4]. Continue to touch the number [4] until your choice is selected from the table below. Then, touch **START/TOUCH ON** pad.

Number [4]	Language	Display
Once	English	ENGLISH
Twice	Espanol	ESPAÑOL
3 Times	French	FR

- Weight/Temp Selection

The oven comes set for U.S. Customary Unit-pounds. To change, touch **CUSTOM HELP** and the number [5]. Continue to touch the number [5] until your choice is selected from the table below. Then, touch **START/TOUCH ON** pad.

Number [5]	Standard of Weight and Temperature	Display
Once	LB. °F	Lb F
Twice	KG °C	KG C

- Help

Each setting of **CompuDefrost**, **CompuBroil**, **CompuRoast**, **CompuBake**, **Sensor Cook** and **Instant Sensor** has a cooking hint. If you wish to check, touch **CUSTOM HELP** whenever **HELP** is lighted in the interactive display.

CLEANING AND CARE

Exterior

The outside surface is precoated metal and plastic. Clean the outside with mild soap and water; rinse and dry with a soft cloth. Do not use any type of household or abrasive cleaner.

Door

Wipe the window on both sides with a damp cloth to remove any spills or splatters. Metal parts will be easier to maintain if wiped frequently with a damp cloth. Avoid the use of harsh abrasives.

Touch Control Panel

Care should be taken in cleaning the touch control panel. If the control panel becomes soiled, open the oven door before cleaning. Wipe the panel with a cloth dampened slightly with water only. Dry with a soft cloth. Do not scrub or use any sort of chemical cleaners. Close door and touch STOP/CLEAR.

Interior - after microwave cooking.

Cleaning is easy because no heat is generated to the interior surfaces; therefore, there is no baking and setting of spills or spattering. To clean the interior surfaces, wipe with a soft cloth and warm water. **DO NOT USE ABRASIVE OR HARSH CLEANERS OR SCOURING PADS.** For heavier soil, use mild soap; rinse thoroughly with hot water.

Interior - after convection, mix or broil cooking.

Spatters may occur because of moisture and grease. Wash immediately after use with hot, soapy water. Rinse and polish dry. Harder to remove spatters may occur if oven is not thoroughly cleaned or if there is long time/high temperature cooking. If so, you may wish to purchase an oven cleaner pad with liquid cleaner within it--not a soap filled steel pad--for use on stainless or porcelain surfaces.

Follow manufacturer's directions carefully and be especially cautious not to get any of the liquid cleaner in the perforations on the wall or ceiling or any door surfaces.

Rinse thoroughly and polish dry.

After cleaning the interior thoroughly, residual grease may be removed from the interior ducts and heater by simply operating the oven on 450°F. for 20 minutes without food. Ventilate the room if necessary.

Waveguide Cover

Carefully wash any food particles from the waveguide cover located on the ceiling in the oven cavity.

Odor Removal

Occasionally, a cooking odor may remain in the oven. To remove, combine 1 cup water, grated peel and juice of 1 lemon, and several whole cloves in a 2 cup glass measuring cup. Boil for several minutes using 100% power. Allow to set in oven until cool. Wipe interior with a soft cloth.

Turntable/Turntable Support/Racks

The turntable, turntable support and racks can be removed for easy cleaning. Wash them in mild, sudsy water; for stubborn stains use a mild cleanser and a non-abrasive scouring sponge. They are also dishwasher-proof. Use top rack of dishwasher for turntable support. Foods with high acidity, such as tomatoes or lemons, will cause the porcelain enamel turntable to discolor. Do not cook highly acidic foods directly on the turntable; if spills occur, wipe up immediately.

The turntable motor shaft is not sealed, so excess water or spills should not be allowed to stand in this area.

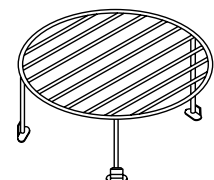
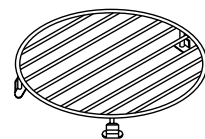
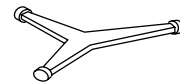
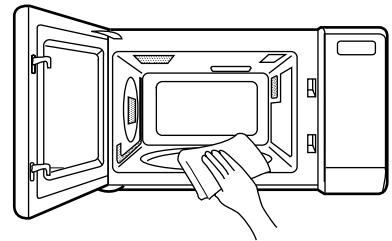
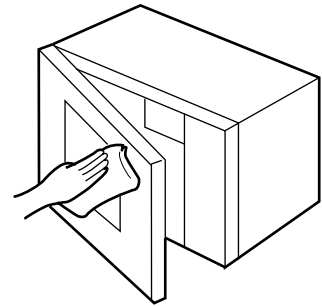

SERVICE CALL CHECK

Please check the following before calling for service:

1. Place one cup of water in a glass measuring cup in the oven and close the door securely.
Operate the oven for two minutes at HIGH 100%.
 - A. Does the oven light come on? YES _____ NO _____
 - B. Does the cooling fan work? YES _____ NO _____
(Put your hand over the rear ventilating openings.)
 - C. Does the turntable rotate? YES _____ NO _____
It is normal for the turntable to turn in either direction.
 - D. Is the water in the oven hot? YES _____ NO _____
2. Remove water from the oven and operate the oven for 5 minutes at CONV 450°F.
 - A. Do CONV and COOK indicators light? YES _____ NO _____
 - B. After the oven shuts off, is inside of the oven hot? YES _____ NO _____

If “NO” is the answer to any of the above questions, please check electrical outlet, fuse and/or circuit breaker.

If both are functioning properly, CONTACT YOUR NEAREST SHARP AUTHORIZED SERVICER. A microwave oven should never be serviced by a “do-it-yourself” repair person.

NOTE: If time appearing in the display is counting down very rapidly, check Demonstration Mode on page 25 and cancel.

SPECIFICATIONS

AC Line Voltage:	Single phase 120V, 60Hz, AC only
AC Power Required:	1.55 kW 13.0A (Microwave) 1.55 kW 13.0A (Convection)
Output Power:	
Microwave	900W*(IEC Test Procedure)
Convection Heater	1450W
Frequency:	2450 MHz
Outside Dimensions:	R-930AK/AW: 24 ⁵ / ₈ "(W) x 14 ⁷ / ₈ "(H) x 19 ¹ / ₈ "(D) R-930CS : 24 ⁵ / ₈ "(W) x 14 ⁷ / ₈ "(H) x 19"(D)
Cavity Dimensions:	16 ¹ / ₈ "(W) x 9 ⁵ / ₈ "(H) x 16 ¹ / ₈ "(D)
Oven Capacity:	1.5 cft
Cooking Uniformity:	Turntable system
Weight:	Approx. 60 lbs.

* the International Electrotechnical Commission’s standardized method for measuring output wattage. This test method is widely recognized.

In compliance with standards set by:







- FCC** – Federal Communications Commission Authorized.
- DHHS** – Complies with Department of Health and Human Services (DHHS) rule, CFR, Title 21, Chapter I, Subchapter J.

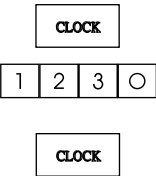

– This symbol on the nameplate means the product is listed by Underwriters Laboratories, Inc.

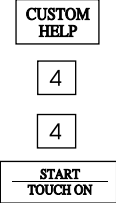
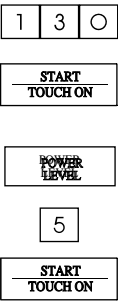
GUIA AUTO-TOUCH

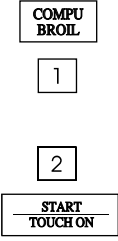
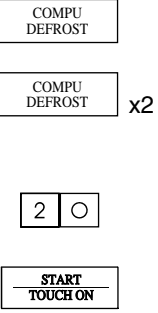
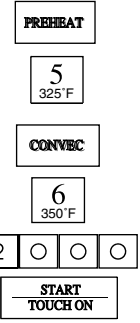
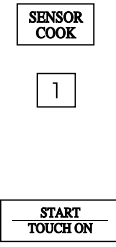
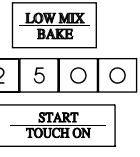

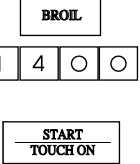







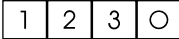





Para mayor información y precauciones de seguridad, consulte el Manual de Operaciones.

<p>FIJACION DEL RELOJ Si en la pantalla aparece SHARP SIMPLY THE BEST PRESS CLEAR AND PRESS CLOCK, toque primero STOP/CLEAR.</p> <ol style="list-style-type: none"> 1. Toque el botón CLOCK. 2. Ponga la hora correcta tocando los números en orden. (Ej. 12:30) 3. Toque nuevamente el botón CLOCK. 		<p>TOUCH ON Toque el botón START/TOUCH ON y mántengalo presionado para cocinar a un 100% del nivel de energía. Al retirar el dedo del botón, el horno se detendrá instantáneamente.</p>	
<p>SELECCIÓN DEL IDIOMA ESPAÑOL</p> <ol style="list-style-type: none"> 1. Toque CUSTOM HELP. 2. Presione 4 para seleccionar el idioma. 3. Presione 4 para seleccionar Español. 4. Toque START. 		<p>OPERACION MANUAL Cocinando con energía alta</p> <ol style="list-style-type: none"> 1. Programe el tiempo para cocinar tocando los botones de números. (Ej. 1 min. 30 seg.) 2. Toque START. <p>Cocinando con energía variable</p> <ol style="list-style-type: none"> 1. Después del paso 1 anterior, toque el botón POWER LEVEL. 2. Escoja el nivel de energía. (Ej. 50%) 3. Toque START. 	
<p>SENSOR INSTANTANEO</p> <ol style="list-style-type: none"> 1. Toque el botón SENSOR REHEAT o POPCORN. (Una vez-regular, 2 veces-snack) 		<p>COMPU BROIL/COMPU ROAST/COMPU BAKE</p> <ol style="list-style-type: none"> 1. Toque el botón COMPU BROIL. 2. Seleccione el ajuste COMPU BROIL deseado. (Ej: Toque [1] para hamburguesas.) 3. Toque el botón número [2] para 2 hamburguesas. 4. Toque START. 	
<p>COMPU DEFROST</p> <ol style="list-style-type: none"> 1. Toque el botón COMPU DEFROST. 2. Seleccione la programación deseada para COMPU DEFROST. (Ej. Toque el botón COMPU DEFROST para filetes.) 3. Toque los botones número [2] y [0]. (Ej. filete de 2,0 libras) 4. Toque START. Durante el descongelamiento, el horno se detendrá para que usted pueda revisar el alimento. Toque el botón START. 		<p>PRECALENTAMIENTO Y COCCIÓN CON CONVECCIÓN</p> <ol style="list-style-type: none"> 1. Toque el botón PREHAT. 2. Seleccione la temperatura de precalentamiento deseada. (Ej: 325°F) 3. Toque el botón CONVEC. 4. Seleccione la temperatura de cocción. (Ej: 350°F) 5. Introduzca el tiempo de cocción tocando los botones de números. (Ej: 20 min.) 6. Toque START. 	
<p>SENSOR COOK</p> <ol style="list-style-type: none"> 1. Toque el botón SENSOR COOK. 2. Seleccione la programación deseada para SENSOR COOK. (Ej. Toque el botón [1] para papas al horno.) 3. Toque el botón START. 		<p>MEZCLA AUTOMÁTICA</p> <ol style="list-style-type: none"> 1. Toque LOW MIX/BAKE o HIGH MIX/ROAST. 2. Introduzca el tiempo de cocción tocando los botones de números. (Ej: 25 min.) 3. Toque START. 	
<p>MINUTE PLUS Toque el botón de adición de un minuto (MINUTE PLUS) para un minuto al 100% de energía, o para añadir un minuto cuando cocine en el modo manual.</p>		<p>ASADO</p> <ol style="list-style-type: none"> 1. Toque BROIL. Sin haber comido en el horno. 2. Introduzca el tiempo deseado tocando los botones de números. (Ej: 14 min.) 3. Toque START. Cuando avise el horno, ponga la comida en su interior. 	

<p>COMPU BROIL</p> <p>1. Touch COMPU BROIL pad.</p> <p>2. Select desired COMPU BROIL setting. (Ex: Touch 1 for hamburgers.)</p> <p>3. Touch number 2 pad for 2 hamburgers.</p> <p>4. Touch START.</p>	<p>COMPU BROIL</p> <p>1</p> <p>2</p> <p>START TOUCH ON</p>	<p>PREHEAT AND COOK WITH CONVECTION</p> <p>1. Touch PREHEAT pad.</p> <p>2. Select desired preheat temperature. (Ex: 325°F)</p> <p>3. Touch CONVEC pad.</p> <p>4. Select cooking temperature. (Ex: 350°F)</p> <p>5. Enter cooking time by touching number pads. (Ex: 20 min.)</p> <p>6. Touch START.</p>	<p>PREHEAT</p> <p>5 325°F</p> <p>CONVEC</p> <p>6 350°F</p> <p>2 0 0 0</p> <p>START TOUCH ON</p>															
<p>COMPU BROIL CHART</p> <table border="1"> <thead> <tr> <th>Setting</th> <th>Food</th> <th>Amount</th> </tr> </thead> <tbody> <tr> <td>1</td> <td>Hamburgers</td> <td>1-8 pieces</td> </tr> <tr> <td>2</td> <td>Chicken pieces</td> <td>0.5-3.5 lbs.</td> </tr> <tr> <td>3</td> <td>Steaks</td> <td>0.5-2.0 lbs.</td> </tr> <tr> <td>4</td> <td>Fish steaks</td> <td>0.5-2.0 lbs.</td> </tr> </tbody> </table>			Setting	Food	Amount	1	Hamburgers	1-8 pieces	2	Chicken pieces	0.5-3.5 lbs.	3	Steaks	0.5-2.0 lbs.	4	Fish steaks	0.5-2.0 lbs.	
Setting	Food	Amount																
1	Hamburgers	1-8 pieces																
2	Chicken pieces	0.5-3.5 lbs.																
3	Steaks	0.5-2.0 lbs.																
4	Fish steaks	0.5-2.0 lbs.																
<p>COMPU ROAST</p> <p>1. Touch COMPU ROAST pad.</p> <p>2. Select desired COMPU ROAST setting. (Ex: Touch 1 for chicken.)</p> <p>3. Touch number pad 2 and 5. (Ex: 2.5 lbs. chicken)</p> <p>4. Touch START.</p>	<p>COMPU ROAST</p> <p>1</p> <p>2 5</p> <p>START TOUCH ON</p>	<p>AUTOMATIC MIX COOKING</p> <p>1. Touch LOW MIX/BAKE or HIGH MIX/ROAST. (Ex: Low Mix/Bake)</p> <p>2. Enter cooking time by touching number pads. (Ex: 25 min.)</p> <p>3. Touch START.</p> <p>NOTE: If you want to change temperature, touch the selected AUTOMATIC MIX pad again after step 1 and touch desired temperature pad.</p>	<p>LOW MIX BAKE</p> <p>2 5 0 0</p> <p>START TOUCH ON</p>															
<p>COMPU ROAST CHART</p> <table border="1"> <thead> <tr> <th>Setting</th> <th>Food</th> <th>Amount</th> </tr> </thead> <tbody> <tr> <td>1</td> <td>Chicken</td> <td>2.5 - 7.5 lbs.</td> </tr> <tr> <td>2</td> <td>Turkey</td> <td>6.5 - 16.0 lbs.</td> </tr> <tr> <td>3</td> <td>Turkey breast</td> <td>3.0 - 6.0 lbs.</td> </tr> <tr> <td>4</td> <td>Pork</td> <td>2.0 - 3.5 lbs.</td> </tr> </tbody> </table>			Setting	Food	Amount	1	Chicken	2.5 - 7.5 lbs.	2	Turkey	6.5 - 16.0 lbs.	3	Turkey breast	3.0 - 6.0 lbs.	4	Pork	2.0 - 3.5 lbs.	<p>BROILING</p> <p>1. Touch BROIL. No food in oven.</p> <p>2. Enter desired time by touching number pads. (Ex. 14 min.)</p> <p>3. Touch START. When oven signals, put food in oven.</p>
Setting	Food	Amount																
1	Chicken	2.5 - 7.5 lbs.																
2	Turkey	6.5 - 16.0 lbs.																
3	Turkey breast	3.0 - 6.0 lbs.																
4	Pork	2.0 - 3.5 lbs.																
<p>COMPU BAKE</p> <p>1. Touch COMPU BAKE pad.</p> <p>2. Select desired COMPU BAKE setting. (Ex: Touch 1 for bundt cake.)</p> <p>3. Touch START.</p>	<p>COMPU BAKE</p> <p>1</p> <p>START TOUCH ON</p>	<p>SLOW COOK</p> <p>1. Touch SLOW COOK pad.</p> <p>2. Touch START.</p> <p>NOTE: If you want to change the temperature (below 300°F), touch SLOW COOK pad again after step 1 and touch desired temperature pad.</p>	<p>SLOW COOK</p> <p>START TOUCH ON</p>															
<p>COMPU BAKE CHART</p> <table border="1"> <thead> <tr> <th>Setting</th> <th>Food</th> <th>Amount</th> </tr> </thead> <tbody> <tr> <td>1</td> <td>Bundt cake</td> <td>1 cake</td> </tr> <tr> <td>2</td> <td>Cookies</td> <td>1-2 pizza pans</td> </tr> <tr> <td>3</td> <td>Muffins</td> <td>6-12 cups</td> </tr> <tr> <td>4</td> <td>French fries</td> <td>3-24 oz.</td> </tr> </tbody> </table>			Setting	Food	Amount	1	Bundt cake	1 cake	2	Cookies	1-2 pizza pans	3	Muffins	6-12 cups	4	French fries	3-24 oz.	
Setting	Food	Amount																
1	Bundt cake	1 cake																
2	Cookies	1-2 pizza pans																
3	Muffins	6-12 cups																
4	French fries	3-24 oz.																

AUTO-TOUCH® GUIDE

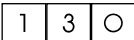
For more complete information and safety precautions, refer to your Operation Manual.

<p>SET CLOCK If SHARP SIMPLY THE BEST PRESS CLEAR AND PRESS CLOCK is in display, first touch STOP/CLEAR.</p> <ol style="list-style-type: none"> 1. Touch CLOCK pad. 2. Enter correct time of day by touching numbers in sequence. (Ex: 12:30) 3. Touch CLOCK pad again. 	  	<p>Variable Power Cooking</p> <ol style="list-style-type: none"> 1. Enter cooking time by touching number pads. (Ex: 5 min) 2. Touch POWER LEVEL pad. 3. Select power level. (Ex: 50%) 4. Touch START pad. 	   																											
<p>INSTANT SENSOR 1. Touch SENSOR REHEAT</p>		<p>SENSOR COOK</p> <ol style="list-style-type: none"> 1. Touch SENSOR COOK pad. 2. Select desired SENSOR COOK setting. (Ex: Touch 1 to cook baked potatoes.) 3. Touch START. 																												
<p>INSTANT SENSOR CHART</p> <table border="1"> <thead> <tr> <th colspan="2">Food</th> <th>Amount</th> </tr> </thead> <tbody> <tr> <td>Popcorn</td> <td>one touch for 3.0-3.5 oz. bags two touches for 1.5-1.75 oz. bags</td> <td>1 package</td> </tr> <tr> <td rowspan="2">Reheat</td> <td>Leftovers</td> <td>4-36 oz.</td> </tr> <tr> <td>Canned entrees and vegetables</td> <td>4-36 oz.</td> </tr> </tbody> </table>			Food		Amount	Popcorn	one touch for 3.0-3.5 oz. bags two touches for 1.5-1.75 oz. bags	1 package	Reheat	Leftovers	4-36 oz.	Canned entrees and vegetables	4-36 oz.	  																
Food		Amount																												
Popcorn	one touch for 3.0-3.5 oz. bags two touches for 1.5-1.75 oz. bags	1 package																												
Reheat	Leftovers	4-36 oz.																												
	Canned entrees and vegetables	4-36 oz.																												
<p>COMPU DEFROST</p> <ol style="list-style-type: none"> 1. Touch COMPUDEFROST pad. 2. Select desired COMPU DEFROST setting. (Ex: Touch COMPU DEFROST twice to defrost steak.) 3. Touch number pads 2 and 0. (Ex: 2.0 lbs. steak) 4. Touch START. During defrosting, oven will stop, check food. Touch START to continue defrosting. 	   	<p>SENSOR COOK CHART</p> <table border="1"> <thead> <tr> <th>Setting</th> <th>Food</th> <th>Amount</th> </tr> </thead> <tbody> <tr> <td>1</td> <td>Baked potatoes</td> <td>1-8 medium</td> </tr> <tr> <td>2</td> <td>Frozen vegetables</td> <td>1-8 cups</td> </tr> <tr> <td>3</td> <td>Fresh vegetables, soft</td> <td>0.25-2.0 lbs.</td> </tr> <tr> <td>4</td> <td>Fresh vegetables, hard</td> <td>0.25-1.5 lbs.</td> </tr> <tr> <td>5</td> <td>Frozen entree</td> <td>6-17 oz.</td> </tr> <tr> <td>6</td> <td>Hot dogs</td> <td>1-4</td> </tr> <tr> <td>7</td> <td>Bacon</td> <td>2-6 slices</td> </tr> <tr> <td>8</td> <td>Fish, seafood</td> <td>0.25-2.0 lbs.</td> </tr> </tbody> </table>		Setting	Food	Amount	1	Baked potatoes	1-8 medium	2	Frozen vegetables	1-8 cups	3	Fresh vegetables, soft	0.25-2.0 lbs.	4	Fresh vegetables, hard	0.25-1.5 lbs.	5	Frozen entree	6-17 oz.	6	Hot dogs	1-4	7	Bacon	2-6 slices	8	Fish, seafood	0.25-2.0 lbs.
Setting	Food	Amount																												
1	Baked potatoes	1-8 medium																												
2	Frozen vegetables	1-8 cups																												
3	Fresh vegetables, soft	0.25-2.0 lbs.																												
4	Fresh vegetables, hard	0.25-1.5 lbs.																												
5	Frozen entree	6-17 oz.																												
6	Hot dogs	1-4																												
7	Bacon	2-6 slices																												
8	Fish, seafood	0.25-2.0 lbs.																												
<p>COMPU DEFROST CHART</p> <table border="1"> <thead> <tr> <th>Setting</th> <th>Food</th> <th>Amount</th> </tr> </thead> <tbody> <tr> <td>1</td> <td>Ground meat</td> <td>0.5-3.0 lbs.</td> </tr> <tr> <td>2</td> <td>Steaks, (chops), (fish)</td> <td>0.5-4.0 lbs.</td> </tr> <tr> <td>3</td> <td>Chicken pieces</td> <td>0.5-3.0 lbs.</td> </tr> </tbody> </table>			Setting	Food	Amount	1	Ground meat	0.5-3.0 lbs.	2	Steaks, (chops), (fish)	0.5-4.0 lbs.	3	Chicken pieces	0.5-3.0 lbs.	<p>MINUTE PLUS Touch Minute Plus for one minute at 100% power or to add a minute during manual cooking.</p> 															
Setting	Food	Amount																												
1	Ground meat	0.5-3.0 lbs.																												
2	Steaks, (chops), (fish)	0.5-4.0 lbs.																												
3	Chicken pieces	0.5-3.0 lbs.																												
<p>MANUAL OPERATION</p> <p>High Power Cooking</p> <ol style="list-style-type: none"> 1. Enter cooking time by touching number pads. (Ex: 1 min. 30 sec.) 2. Touch START pad. 	 	<p>TOUCH ON Continuously touch TOUCH ON/START for 100% power cooking. Remove finger and oven will stop instantly.</p> 																												

Carousel and Auto-Touch are registered trademarks of Sharp Corporation.

SHARP®

SHARP ELECTRONICS CORPORATION
Sharp Plaza, Mahwah, New Jersey 07430-2135

TINSEA815WRR0-D04 Printed in Thailand