

BALDWIN®

5173S

ESTATE LEVER

SPECIFICATIONS

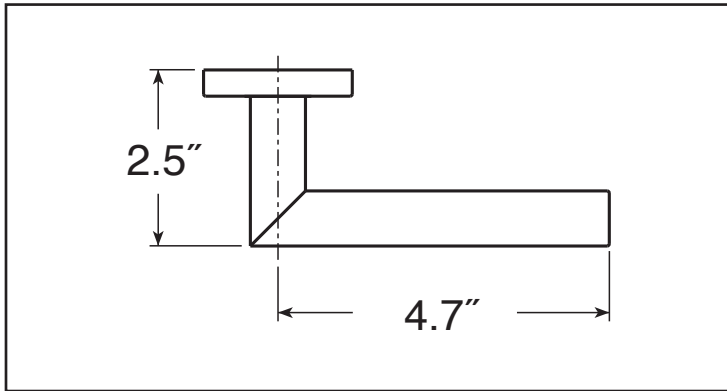

- > Accessibility Code (ADA) A117.1 for all levers.
- > Certified by Underwriters Laboratories (UL) for use on fire doors up to three-hour rating
- > U L10C / UBC 7-2 (1997) Positive Pressure Rated, UL10B Pressure Rated
- > Material: Stainless Steel

SHOWN WITH ROSE 5032S



**TIER 1 FINISHES:
STAINLESS STEEL HARDWARE ONLY**

