



Elizabethan Classics

Specification for ECRT67RM

Hole	Diameter
Drain	2" +/- 1/8
Over Flow	2-1/4" +/- 3/16
Faucet	1-3/8" +/- 1/8
Capacity	57.329 US Gallon
Weight of Tub	330.69 lbs
Weight of Tub filled with water	808.09 lbs

Top View

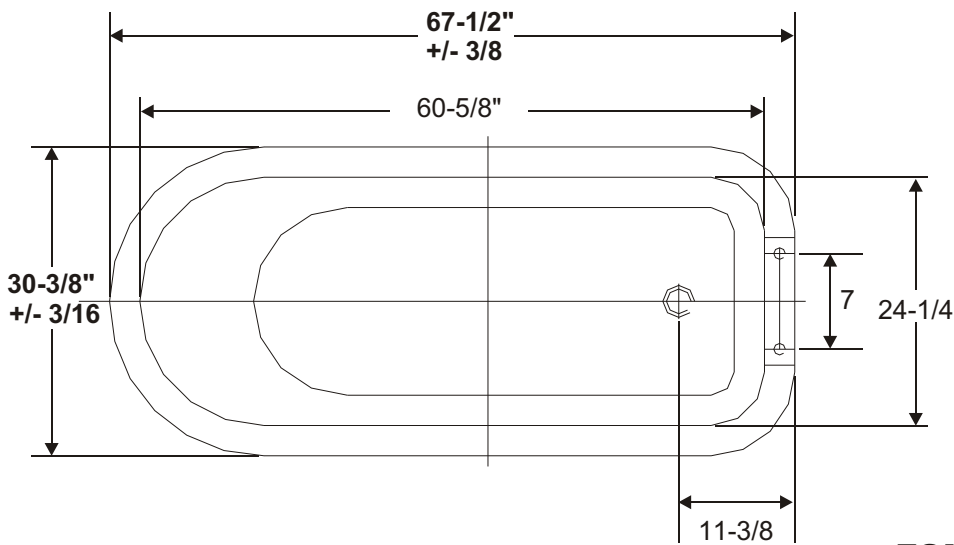

End View

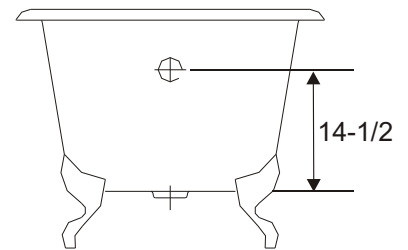

Side View

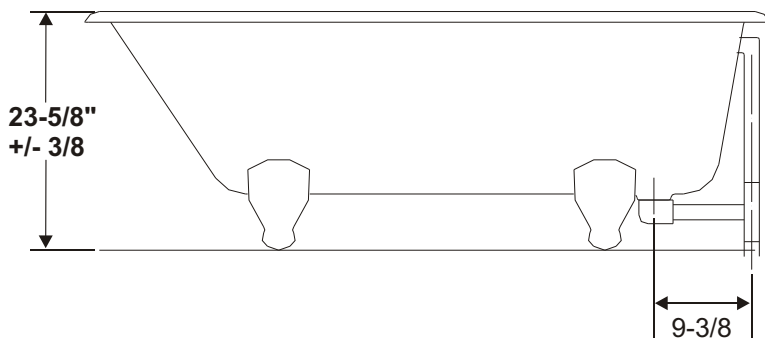

FSMR Feet Placement Diagram

