

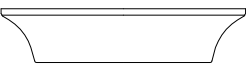

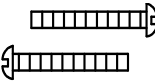







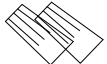
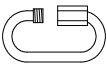

Fixture Name: Hampden 6262-9 DNI

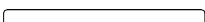
This fixture assembled PO: _____ Date: _____

Notice: Please review the parts listing and check for all parts before assembling the fixture. If any parts are missing or damaged, please note on this sheet and contact the place of purchase to arrange for replacement parts.

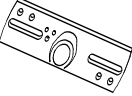
PARTS LIST		Company Name: _____ Co. Account #: _____ to be filled out by retailer	
Canopy 1ea Ø5-1/2"*H1-1/4"		Mounting Screws 2ea 8#32-IP*1"	
Chain 1ea 6ft Ø4.2		Wire connectors 3ea P3 Orange	
Chain connector 2ea Ø5.8*H61mm		Canopy loop with Collar 1ea Ø1-1/8"*H42mm	
Nipple 1ea 1/8-IP*H440mm		Hex Nut 1ea 1/8-IP*H4mm	
Cover 1ea Ø2"*H5mm		Center column 1ea Ø2"*H438mm	
Top loop 1ea 1/8-IP*H60mm		Nipple 1ea 1/4-IP*H60mm	
Mounting strap 1ea W4-1/8"*E1"*H5mm		Top cap 1ea Ø3-1/4"*H26mm	
Part Needed _____	Quantity _____		
Part Needed _____	Quantity _____		
Reason why _____	(missing, scratched, broken glass, bent, bad finish)		
Comments _____			

FIXTURE ASSEMBLY INSTRUCTIONS

Read and review installation instruction sheet before assembling the fixture.

ASSEMBLING THE FIXTURE (Fig.1)

1. Gently spread the arms until evenly spaced if arms are packed closed
2. Thread the Nipple (V) into Hickey (R), then tighten.
3. Slide the Center column (T) over the long Nipple (V) and top with the Cover (S) and Top cap (M), tighten securely to the Nipple using the washer (W) and the Hex Nut (U).

NOTE: INSTALL THE GLASS ASSEMBLY AFTER THE FIXTURE IS HUNG.

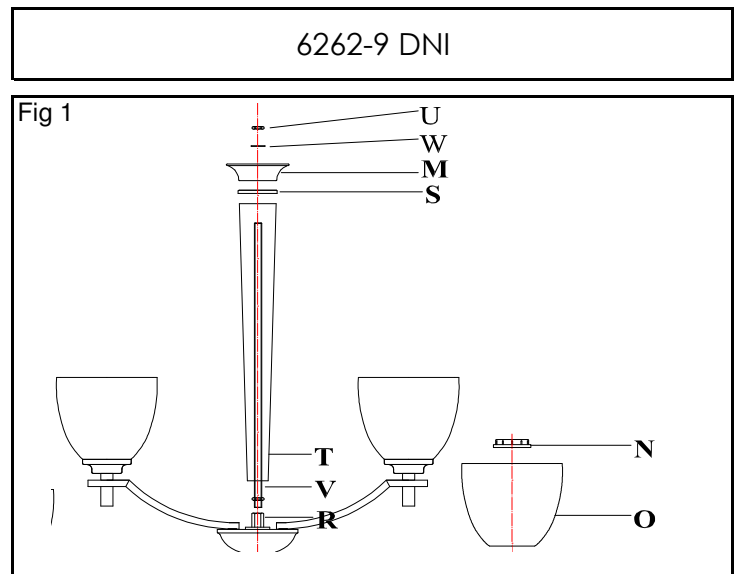

For Customer Service, contact the place of purchase to arrange for replacement parts.

PARTS & ASSEMBLY SHEET

Fixture Name: Hampden 6262-9 DNI

ASSEMBLING THE FIXTURE (Fig.2)

4. Feed the fixture wires through the Top loop (J) and pull the wires until taut.

5. Then screw the Top Loop (J) to the threaded center column of Frame (M) until tight.

6. By measuring determine correct number of links needed for proper hanging height. Use a pair of pliers to open one link of the Chain (C2) then remove the excess Chain (C2) and discard it.

7. Use one chain connector(E2) to attach one end of the chain to the Top loop (D2) and close the chain connector.

8. Feed the fixture wires through the Chain (every three links) and pull the wires until taut.

9. Slip Canopy loop collar (B2) over the chain, then do the same with the canopy (F2).

10. When ready to complete the installation Use the other chain connector and attach the other end of the chain to the canopy loop (A2) and close the chain connector.

11. Make sure the weight of the chandelier will be supported by the chain-not the electrical wire.

* You may now install the fixture.

Note: Complete these remaining steps after the fixture is hung.

12. Place the Glass Shades(O) over the Threaded sockets(P) secure the Glass Shades (O) by threading by the Socket Rings (N) until tight.

13. Install the light bulbs in accordance with the fixture's specifications.

(DO NOT EXCEED MAXIMUM WATTAGE RATING)

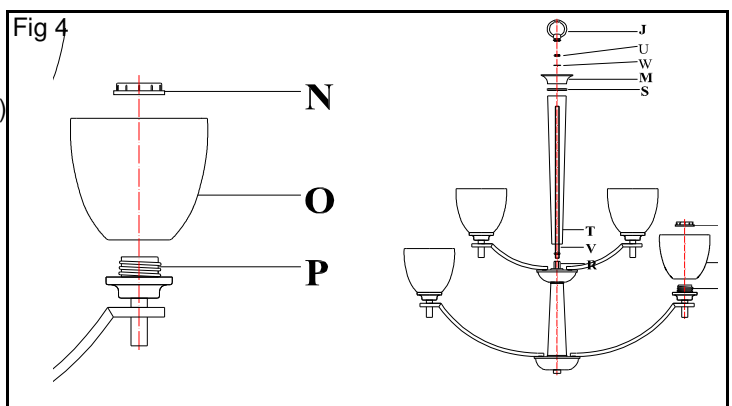
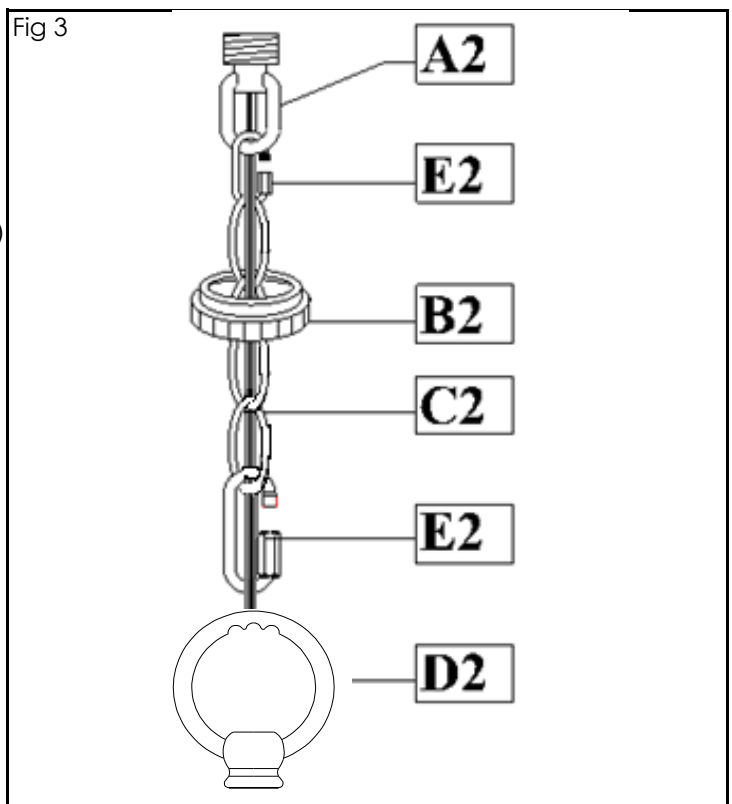
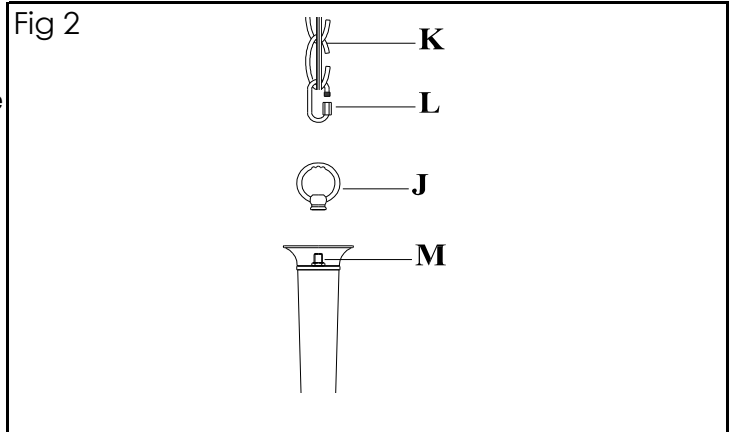

For Customer Service, contact the place of purchase to arrange for replacement parts.

Fixture Name: Hampden 6262-D5, 6, 9, 3P DNI

For Chandelier Light Fixture

WARNING ! SHUT OFF POWER AT FUSE OR CIRCUIT BREAKER.

HANGING THE FIXTURE (Fig.1)

1. Carefully remove the new fixture from the carton and the yellow bag that holds all parts. Check that all parts are included as shown in the illustration and parts list.
2. Shut off the power at the circuit breaker and remove old fixture from ceiling, including the old mounting strap.
3. Thread Nipple(C) into Canopy Loop (F) until snug.
4. Thread other end of the Nipple (C) with Canopy Loop attached into Mounting Strap (D).
5. Place Lock Washer (B) over end of Nipple (C) protruding through Mounting Strap (D) and thread Hex Nuts (A) onto Nipple until tight.
6. Take this mounting strap assembly and mount to ceiling junction box with junction box Screws (E). Tighten screw securely with screw driver.
7. Unscrew the Canopy loop collar(H) from the Canopy loop. Take the canopy and pass over the Canopy loop. approximately one half of the canopy loop exterior threads should be exposed. Adjust until desired height is reached. *the Canopy loop collar should fit snugly on the Canopy loop after the canopy is installed. Remove Canopy and Canopy lock collar.
8. Assemble the fixture and have an assistant or secure support hold the weight of the fixture while you complete the wiring connections.
9. Thread the fixture wires and ground wire of the assembled fixture through the canopy loop and nipple and into the outlet box.

CONNECTING THE WIRES (Fig 2)

10. Attach the power supply wires to the fixture lead wires by connecting BLACK to BLACK (or SMOOTH) and WHITE to WHITE (or RIBBED).
11. Attach the GROUND wire(GREEN or COPPER) from the Junction Box and the fixture Ground wire to the green Ground Screw on the Mounting Bracket (D) or connect both wires together using the correct size of wire connectors.

NOTE: Twist the wires together in the same direction you twist the wire connector onto the wires.

12. Tuck these wire connections neatly into the Junction Box.
13. Raise Canopy (G) to the ceiling and secure in place by tightening the Canopy loop collar(H) into the Canopy Loop(F)
14. Install the light bulbs and glass shade as per the fixture assembly sheet.

Fig. 1

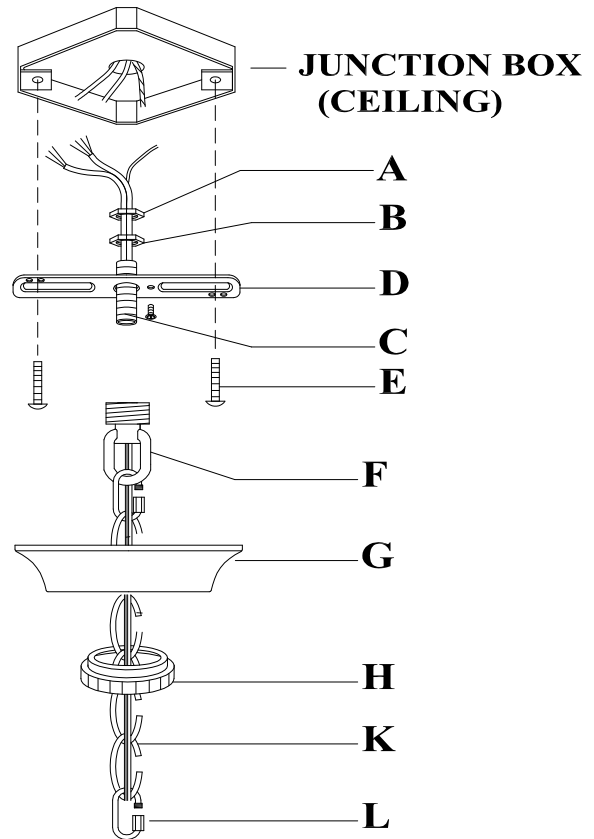
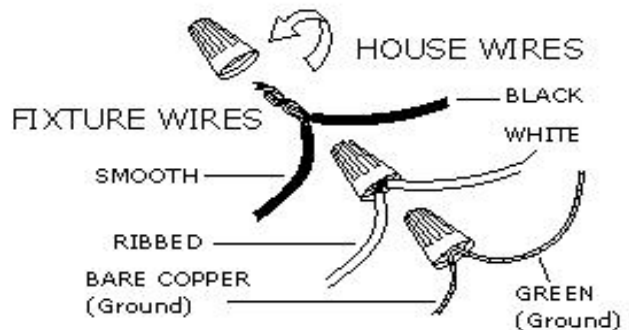

Fig. 2



YOUR INSTALLATION IS NOW COMPLETE. RETURN POWER TO THE JUNCTION BOX AND TEST THE FIXTURE.