

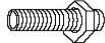









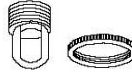

Fixture Name: **Mayfair 7116-6 LC**

This fixture assembled PO: \_\_\_\_\_ Date: \_\_\_\_\_

**Notice:** Please review the parts listing and check for all parts before assembling the fixture. If any parts are missing or damaged, please note on this sheet and contact the place of purchase to arrange for replacement parts.

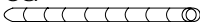
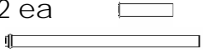
<b>PARTS LIST</b>		Company Name: _____ Co. Account #: _____		
to be filled out by retailer				
Canopy	1ea 	Nipple	1ea 	
Chain	6ft 	Wire connectors	2ea 	
Chain connector	2ea 	Hex Nut	2ea 	
Mounting Strap w/ ground screw	1ea 	Canopy Loop and Canopy loop collar	1ea 	
Mounting screws	2ea 	Deco Cap	2ea 	
			Top loop	1ea 
			Nipple / Threaded rod	1ea 
			Deco rod	2 ea 
			Arm connector w/ 6 Deco screws	2 ea 
			Finial (attached to arm connector)	2ea 
Part Needed	_____		Quantity	_____
Part Needed	_____		Quantity	_____
Reason why	( missing, scratched, broken glass, bent, bad finish)			
Comments	_____			

## FIXTURE ASSEMBLY INSTRUCTIONS

Read and review installation instruction sheet before assembling the fixture.

### ASSEMBLING THE FIXTURE (Fig.1)

- Slide the long Threaded rod(B) down through the Deco rod (L) and Top cap (M). Screw Threaded rod (B) all the way into the coupler at top of fixture frame and secure with Hex nut(N).
- Slide the Top cap (M), the long Deco rod (L) and Arm connector (K) down over the Threaded rod (B).
- Secure in place with a threaded Deco cap (O) then small Deco rod (P) then the second threaded Deco cap (O).
- Feed the fixture wires through the Top loop (A) and pull the wires until taut. Then screw the Top Loop (A) to the Threaded rod (B) until tight.

**NOTE: INSTALL THE GLASS ASSEMBLY AFTER THE FIXTURE IS HUNG.**

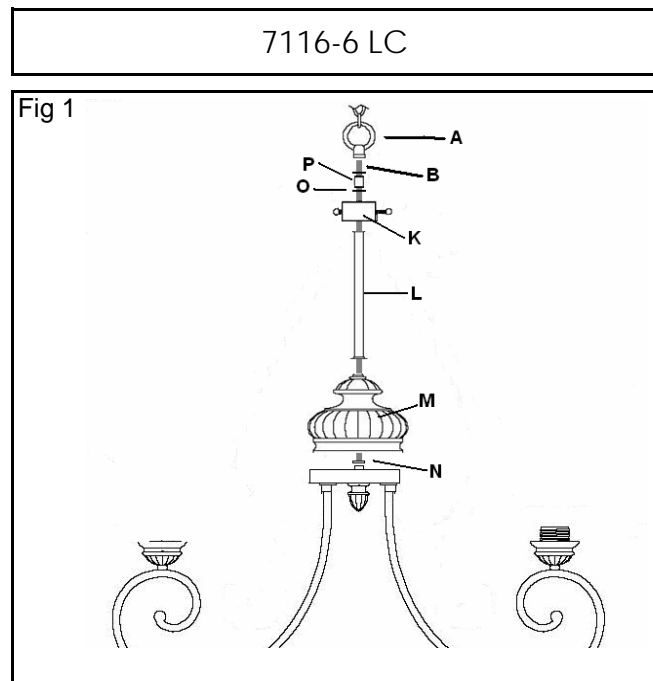

# PARTS & ASSEMBLY SHEET

Fixture Name: Mayfair 7116-6 LC

5. Gently spread the six arms (H) until evenly spaced.
6. Unscrew the 6 Deco screws (C) from the Arm connector with Finials attached (I) and save.
7. Align the hole in lower side of Frame arm (H) with hole in Arm connector(I). Fasten with the Deco screw (C).
8. Repeat with remaining arms and Deco screws.
9. Unscrew the 6 Deco screws (C) from the Arm connector at top of fixture (K) and save.
10. Align the hole in top curve of Deco arm (J) with hole in Arm connector(K). Fasten with the Deco screw (C).
11. Tuck the bottom curve of Deco arm (J) into the slot at top of fixture arm. \* The deco arm is flexible, you can bend it gently for a better fit. If the deco arms and fixture arms do not align turn the arm connector to the right or left until they do.
12. Repeat with remaining arms and Deco screws.

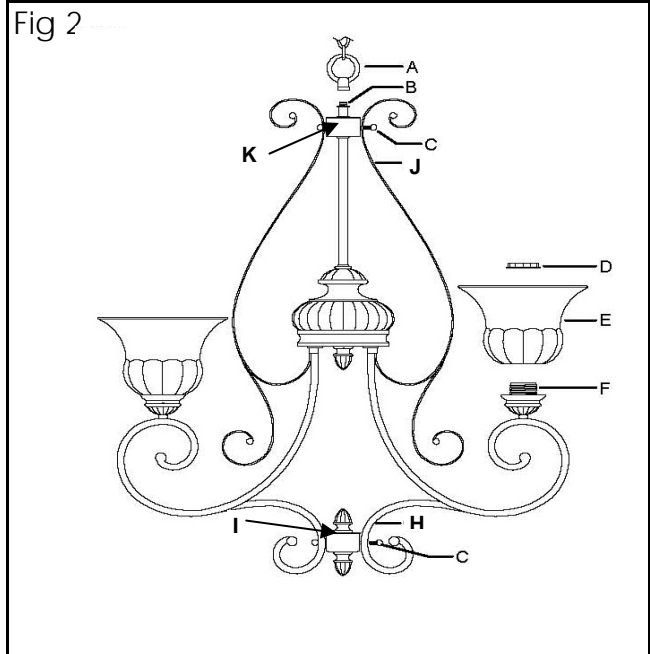

13. By measuring determine correct number of links needed for proper hanging height. Use a pair of pliers to open one link of the Chain (C2) then remove the excess Chain (C2) and discard it.
  14. Use one chain connector(E2) to attach one end of the chain to the Top loop (D2) and close the chain connector.
  15. Feed the fixture wires through the Chain (every three links) and pull the wires until taut.
  16. Slip Canopy loop collar (B2) over the chain, then do the same with the canopy (F2).
  17. When ready to complete the installation Use the other chain connector and attach the other end of the chain to the canopy loop (A2) and close the chain connector.
  18. Feed the fixture wires through canopy loop (A2) and nipple(C) and pull until taut.
- \* You may now install the fixture.

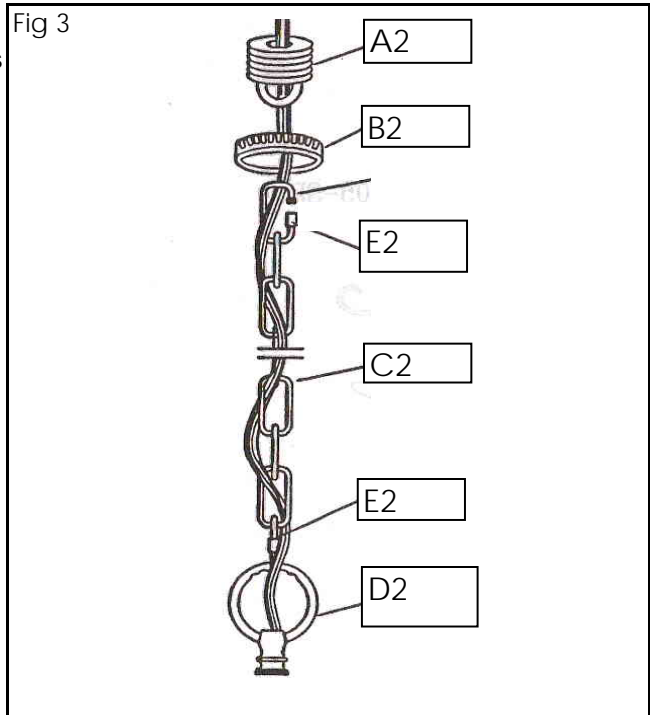

- Note: Complete these remaining steps after the fixture is hung.
19. Place the Glass Shade(E) over the Threaded Socket(F), secure the Glass Shade(E) by threading by the Socket Ring(D) until tight.
  20. Install the light bulbs in accordance with the fixture's specifications.
- (DO NOT EXCEED MAXIMUM WATTAGE RATING)

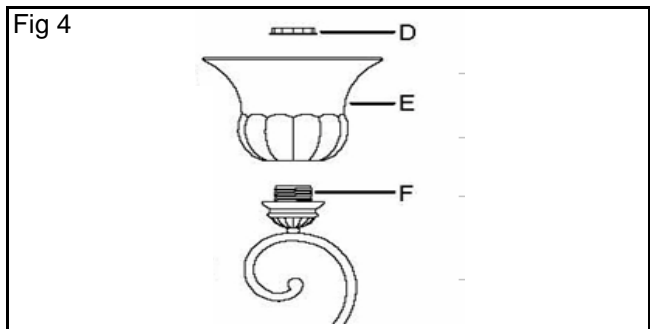

For Customer Service, contact the place of purchase to arrange for replacement parts.

## WARNING! SHUT OFF POWER AT FUSE OR CIRCUIT BREAKER.

### HANGING THE FIXTURE (Fig.1)

- Carefully remove the new fixture from the carton and the yellow bag that holds all parts. Check that all parts are included as shown in the illustration and parts list.
- Shut off the power at the circuit breaker and remove old fixture from ceiling, including the old mounting strap.
- Thread Nipple(C) into Canopy Loop (E) until snug.
- Thread other end of the Nipple (C) with Canopy Loop attached into Mounting Strap (D).
- Thread Washer and Hex Nut (B) onto Nipple until snug to the Mounting strap(D).
- Take this mounting strap assembly and mount to ceiling junction box with Mounting Screws (A). Tighten screws securely with screw driver.
- Unscrew the Canopy loop collar(H) from the Canopy loop. Take the canopy and pass over the Canopy loop. approximately one half of the canopy loop exterior threads should be exposed. Adjust until desired height is reached. \*the Canopy loop collar should fit snugly on the Canopy loop after the canopy is installed. Remove Canopy and Canopy loop collar.
- Assemble the fixture and have an assistant or secure support hold the weight of the fixture while you complete the wiring connections.
- Thread the fixture wires and ground wire of the assembled fixture through the canopy loop and nipple and into the outlet box.

### CONNECTING THE WIRES (Fig 2)

- Attach the power supply wires to the fixture lead wires by connecting BLACK to BLACK (or SMOOTH) and WHITE to WHITE (or RIBBED).
- Attach the GROUND wire(GREEN or COPPER) from the Junction Box and the fixture Ground wire to the green Ground Screw on the Mounting Bracket (D) or connect both wires together using the correct size of wire connectors. - NOTE: Twist the wires together in the same direction you twist the wire connector onto the wires.
- Tuck these wire connections neatly into the Junction Box.

### FINISHING THE INSTALLATION

- Raise Canopy (G) to the ceiling and secure in place by tightening the Canopy loop collar(H) onto the Canopy Loop(E)
- Install the light bulbs and glass shade as per the fixture assembly sheet.

Fig. 1

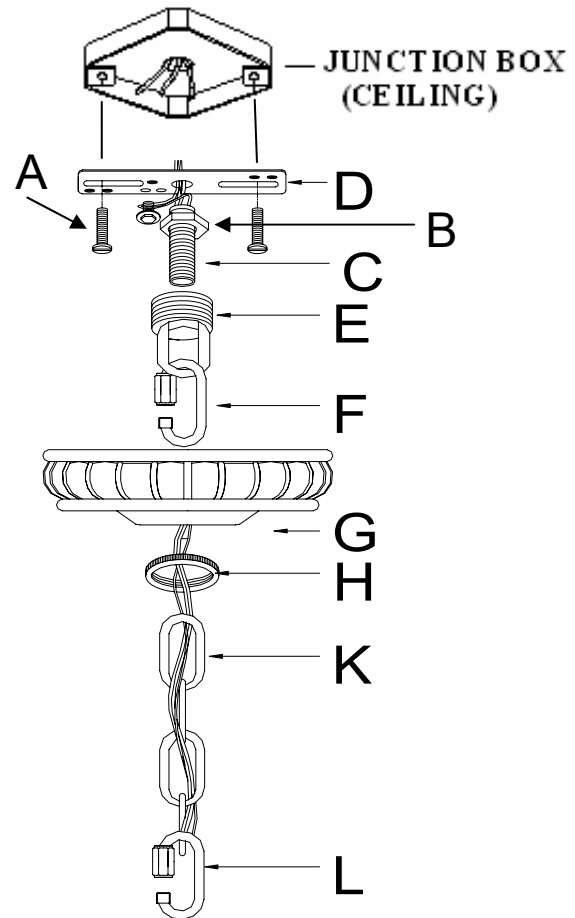
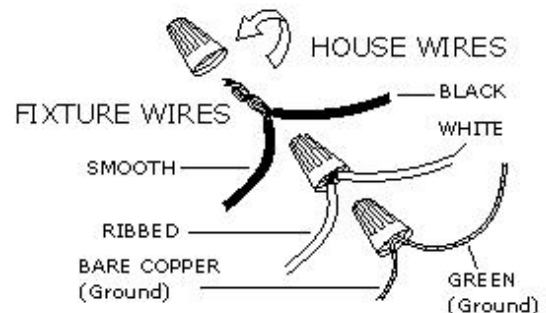

Fig. 2



**YOUR INSTALLATION IS NOW COMPLETE.  
RETURN POWER TO THE JUNCTION BOX  
AND TEST THE FIXTURE.**