







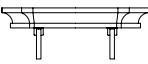
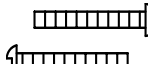

Fixture Name: **Sterne 1054-10 ST**

This fixture assembled PO: _____ Date: _____

Notice: Please review the parts listing and check for all parts before assembling the fixture. If any parts are missing or damaged, please note on this sheet and contact the place of purchase to arrange for replacement parts.

PARTS LIST

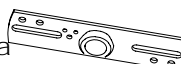
Company Name: _____ Co. Account #: _____
to be filled out by retailer

Canopy	1ea 	Mounting Screws	2ea 	Top loop	4ea 
Chain	6ft  2ea	Wire Connectors	3ea 	Nipple	1ea 
Chain connector	4ea 	Finial	1ea 	Mounting Strap	1ea 
Socket rings	4ea 	Hex Nut	3ea 		

Part Needed _____	Quantity _____
Part Needed _____	Quantity _____
Reason why (missing, scratched, broken glass, bent, bad finish)	
Comments _____	

FIXTURE ASSEMBLY INSTRUCTIONS

Read and review installation instruction sheet before assembling the fixture.

ASSEMBLING THE FIXTURE (Fig.1)

1. By measuring determine correct number of links needed for proper hanging height. Use a pair of pliers to open one link of the Chain (J) then remove the excess chain (J) and discard it.
2. Use Chain connector (K) to attach the Top loop (L) to one end of chain (J) and close the connector as shown. (disregard if the Top loop is already attached to one end of chain)
3. Attach a Chain connector (K) to the top end of the Chain (J). Repeat steps 1 thru 3 for the second chain.

NOTE: INSTALL THE GLASS ASSEMBLY AFTER THE FIXTURE IS HUNG.

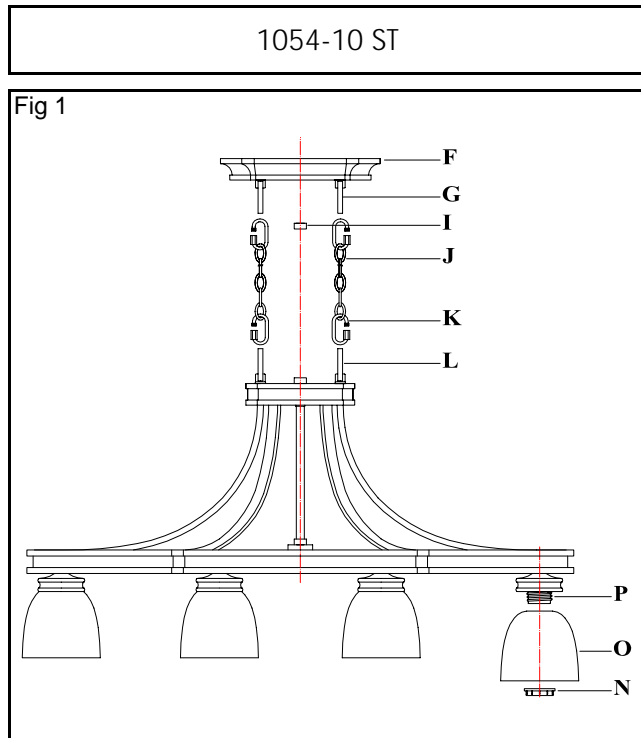

PARTS & ASSEMBLY SHEET

Fixture Name: Sterne 1054-10 ST

ASSEMBLING THE FIXTURE (Fig. 2)

4. Thread the Top Loop (A2) into the top of the fixture Frame (L). Lace the fixture's wire through the Top loop (A2) and the chain links (C2) (every three links) and pull until taut.
5. Use Chain connector (B2) to attach the top of Chain (C2) to the Canopy loop (A2) and close the chain connector as shown.
6. Make sure the weight of the chandelier will be supported by the chain-not the electrical wire.

* You may now install the fixture.

Fig 2

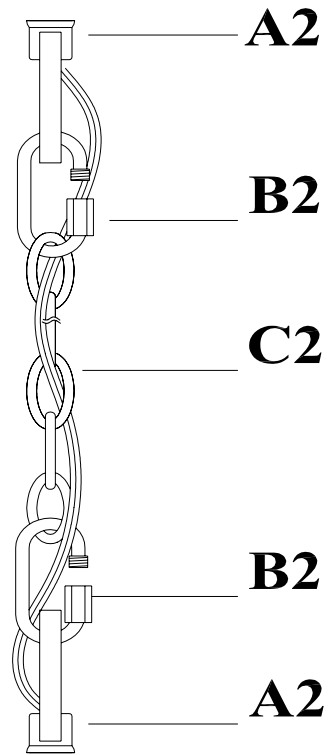

Note: Complete these remaining steps after the fixture is hung.

7. Place the Glass Shades (O) over the Threaded Socket (P), secure the Glass Shades (O) by threading by the Socket Rings (N) until tight.
8. Install the light bulbs in accordance with the fixture's specifications.

(DO NOT EXCEED MAXIMUM WATTAGE RATING)

Fig 3

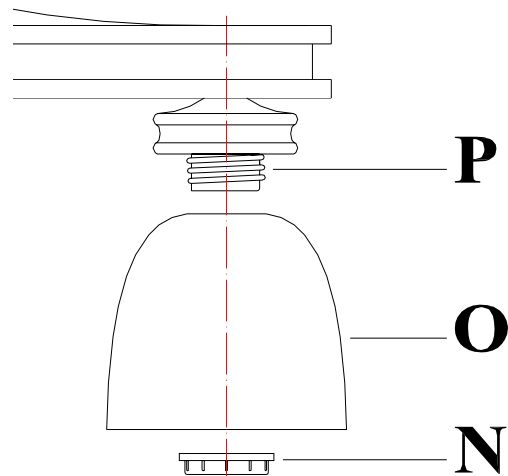

For Customer Service, contact the place of purchase to arrange for replacement parts.

WARNING ! SHUT OFF POWER AT FUSE OR CIRCUIT BREAKER.

HANGING THE FIXTURE (Fig.1)

- Carefully remove the new fixture from the carton and the yellow bag that holds all parts. Check that all parts are included as shown in the illustration and parts list.
- Shut off the power at the circuit breaker and remove old fixture from ceiling, including the old mounting strap.
- Thread the Nipple(C) with Canopy Loop attached into Mounting Strap (D).
- Place Lock Washer (B) over end of Nipple (C) protruding through Mounting Strap (D) and thread Hex Nuts (A) onto Nipple until tight.
- Take this mounting strap assembly and mount to ceiling junction box with junction box Screws (E). Tighten screw securely with screw driver.
- Assemble the fixture and have an assistant or secure support hold the weight of the fixture while you complete the wiring connections
- Thread the fixture wires and ground wire of the assembled fixture through the nipple and into the outlet box.

CONNECTING THE WIRES (Fig 2)

- Attach the power supply wires to the fixture lead wires by connecting BLACK to BLACK (or SMOOTH) and WHITE to WHITE (or RIBBED).
 - Attach the GROUND wire(GREEN or COPPER) from the Junction Box and the fixture Ground wire to the green Ground Screw on the Mounting Bracket (D) or connect both wires together using the correct size of wire connectors.
- NOTE:** Twist the wires together in the same direction you twist the wire connector onto the wires.
- Tuck these wire connections neatly into the Junction Box.

FINISHING THE INSTALLATION (Fig.3)

- Place the fixture canopy (F), over the threaded rod (C), so it protrudes through the hole in the Canopy (F). Thread the Deco nut (I) onto the threaded rod and continue turning until the Canopy (F) is snug against the ceiling.
- Install the light bulbs and glass shade as per the fixture assembly sheet.

YOUR INSTALLATION IS NOW COMPLETE. RETURN POWER TO THE JUNCTION BOX AND TEST THE FIXTURE.

