

Installation Instructions / Warranty

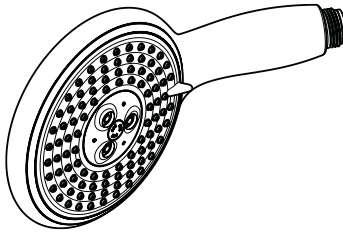

Raindance E 100 AIR 3-Jet
28507xx1

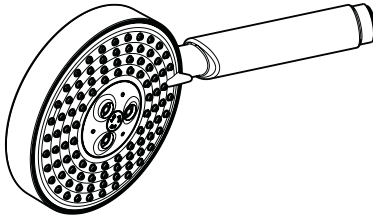

Raindance S 100 AIR 3-Jet
28514xx1

hansgrohe

28507xx1

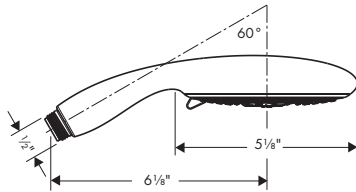
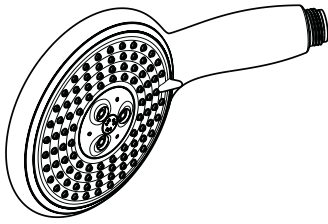

Rain AIR



Balance AIR



Whirl AIR

28514xx1

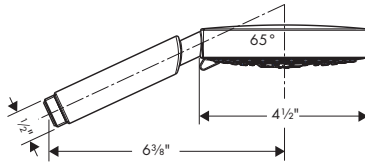
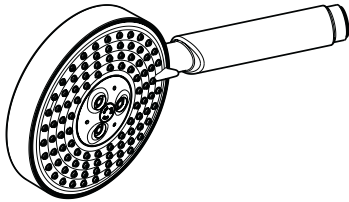

Rain AIR



Balance AIR



Whirl AIR

Technical Information / Données techniques / Datos técnicos

Max. flow rate

Capacité nominale

Caudal máximo

2.5 gpm

- For use with automatic compensating valves rated at 2.2 GPM (8.5L/min) or less.
- Ce produit est pour l'usage avec une soupape automatiquement compensatrice a évalué à 2,2 GPM (8.5 L/min) ou moins.
- Este producto es para el uso con una válvula automáticamente compensando valoró en 2,2 GPM (8.5 L/min) o menos.

Installation Considerations

- For best results, Hansgrohe recommends that this unit be installed by a licensed, professional plumber.
- Please read over these instructions thoroughly before beginning installation. Make sure that you have all tools and supplies needed to complete the installation.
- This unit does not include a wall supply. It must be used with Hansgrohe model 27458xx3 or another approved supply that complies with ASME A112.18.1/CSA B125.1 including ASME A112.18.3.
- To prevent scald injury, the maximum output temperature of the shower valve must be no more than 120°F. In Massachusetts, the maximum output temperature of the shower valve can be no higher than 112°F.
- Keep this booklet and the receipt (or other proof of date and place of purchase) for this product in a safe place. The receipt is required should it be necessary to request warranty parts.

À prendre en considération pour l'installation

- Pour de meilleurs résultats, Hansgrohe recommande que ce produit soit installé par un plombier professionnel licencié.
- Veuillez lire attentivement ces instructions avant de procéder à l'installation. Assurez-vous de disposer de tous les outils et du matériel nécessaires pour l'installation.
- Ce produit n'est pas fourni avec un coude de raccordement. Il doit être utilisé avec le modèle 27458xx3 d'Hansgrohe ou un autre coude approuvé et conforme à la norme ASME A112.18.1/CSA B125.1, incluant ASME A112.18.3.
- Pour empêcher des blessures par ébullition, la température de sortie maximale du robinet de douche ne doit pas excéder 120°F. Au Massachusetts, la température de sortie maximale du robinet de douche ne doit pas excéder 112°F.
- Conservez ce livret et le reçu (ou une autre preuve sur laquelle figurent la date et l'endroit de l'achat) pour ce produit dans un endroit sûr. Le reçu est requis si vous commandez des pièces sous garantie.

Consideraciones para la instalación

- Para obtener mejores resultados, la instalación debe estar a cargo de un plomero profesional matriculado.
- Antes de comenzar la instalación, lea estas instrucciones detenidamente. Asegúrese de tener las herramientas y los insumos necesarios para completar la instalación.
- Esta unidad no incluye una toma de pared (coude de raccordement/toma de agua) Debe utilizarse con el modelo Hansgrohe 27458xx3 u otra toma aprobada que cumpla con las normas ASME A112.18.1/CSA B125.1, incluida la norma ASME A112.18.3.
- Para evitar escaldaduras, la máxima temperatura de salida de la válvula de la ducha no debe exceder los 120°F. En Massachusetts, la máxima temperatura de salida de la válvula de la ducha no debe exceder los 112°F.
- Mantenga este folleto y el recibo (u otro comprobante del lugar y fecha de compra) de este producto en lugar seguro. El recibo se requiere en caso de ser necesario solicitar piezas bajo garantía.

Installation

Place the screen washer in the end of the hose.
Connect this end of the hose to the handshower.

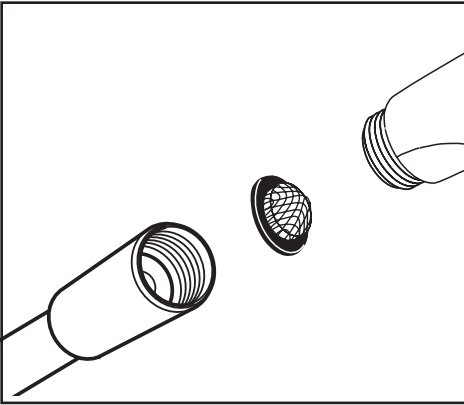

Cleaning

Remove scale deposits from the spray channels by rubbing across them with fingers or a sponge.



If the flow of water reduces over time, remove the screen washer.

Rinse the screen washer with clear water and replace.

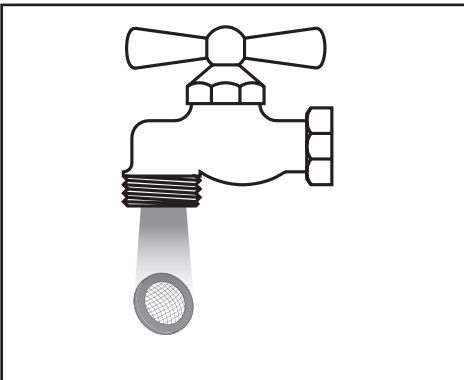

Installation

Placez le tamis dans l'extrémité du tuyau.

Connectez cette extrémité du tuyau à la douchette.

Nettoyage

Si les canaux de jet deviennent entartrés, frottez-les avec les doigts ou à l'aide d'une éponge pour en déloger les dépôts.

Si le débit d'eau diminue avec le temps, retirez le tamis.

Rincez-le à l'eau claire et remettez-le en place.

Instalación

Coloque la arandela de filtro en el extremo de la manguera.

Conecte este extremo de la manguera a la ducha de mano.

Limpiar

Elimine los depósitos calcificados de los canales de rociado frotándolos con los dedos o una esponja.

Si el caudal de agua disminuye con el tiempo, retire la arandela de filtro de la manguera.

Enjuague la arandela de filtro con agua limpia y vuelva a colocarla.

English

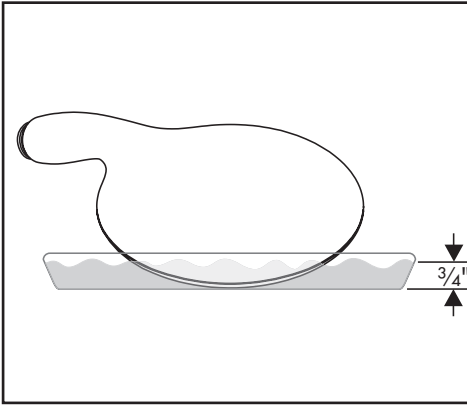

Remove scale deposits from the spray face by soaking it in a commercial scale remover such as Lime-Away or CLR.

Follow the instructions on the product label.

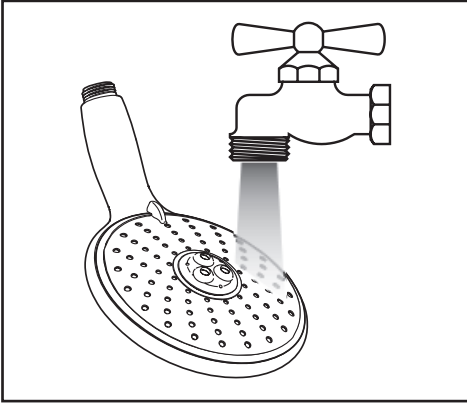

Rinse the handshower with clear water.

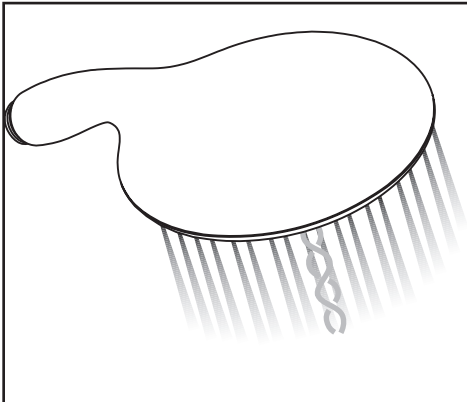

Install the handshower and flush it for at least one minute.

Français

Si la face des jets s'entartre, faites-la tremper dans un détartrant commercial, tel que Lime-Away ou CLR.

Suivez les instructions figurant sur l'étiquette du produit.

Rincez la douchette à l'eau claire.

Installez la douchette et faites-la fonctionner pendant au moins une minute.

Español

Elimine los depósitos calcificados de la superficie de rociado remojándola en un desincrustante comercial como Lime-Away o CLR.

Siga las instrucciones de la etiqueta del producto.

Enjuague la ducha de mano con agua limpia.

Instale la ducha de mano y lávela durante un minuto como mínimo.

User Instructions / Instructions de service / Manejo

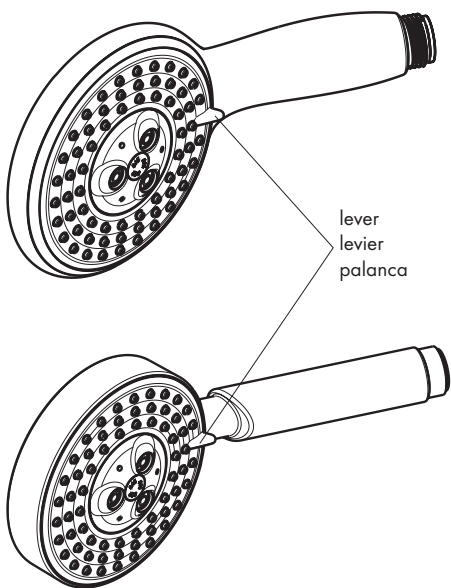

- To change the spray mode, push the lever.
- Pour changer le mode de jet, pousser le levier.
- Para cambiar el modo de rocío, empuje la palanca.



Rain AIR



Balance AIR



Whirl AIR

Replacement Parts / Pièces détachées / Repuestos

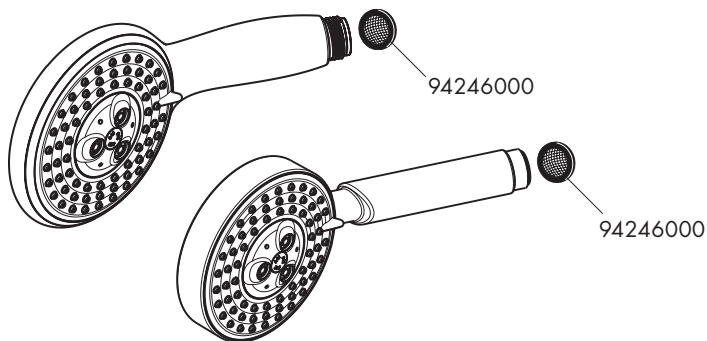

Cleaning Recommendation for Hansgrohe Products

Modern bathroom faucets, kitchen faucets and shower products are made from different materials to comply with the needs of the market with regard to design and functionality. To avoid damage to the product, it is necessary to take proper care of it.

For best results:

- Prevent the buildup of mineral scale and /or soap residue by cleaning your Hansgrohe product(s) when needed.
- Select a cleaning agent specifically intended for the type of product.
- **Do not** use these types of cleaners as they will cause damage to your Hansgrohe product:
 - ✘ Any cleaning agent containing hydrochloric acid, formic acid, lye, or acetic acid.
 - ✘ Abrasive cleaning powders, pads, or brushes.
 - ✘ Steam cleaners.
 - ✘ "No rinse" cleaning agents.
- **Always** follow the instructions provided by the manufacturer of the cleaning agent.
- **Do not** mix cleaning agents, unless directed by the manufacturer.
- **Do not** spray cleaners directly onto the product as drops could enter openings and gaps and cause damage. When using spray cleaners, spray the cleaner onto a soft cloth or sponge.
- **Always** rinse your Hansgrohe product thoroughly with clear water and polish dry with a soft cloth after cleaning.

Important

- Residue from soaps and shampoos can cause damage. Rinse the product with clean water after each use.
- Residue from basin/tub/tile cleaner can cause damage to faucets and fittings. Immediately rinse any overspray from the Hansgrohe product.
- **Damage to the product caused by improper care or the use of improper cleaning agents is not covered by the warranty.**
- **If a component of the product is damaged, replace it, as there is risk of injury.**

Conseil de nettoyage pour les produits Hansgrohe

De nos jours le sanitaire moderne, la robinetterie et les douchettes se composent de matériaux très différents pour satisfaire à la demande concernant le design et la fonctionnalité. Pour éviter les détériorations et les réclamations, aussi bien pour l'utilisation que pour le nettoyage prochain, certains critères seront à prendre en considération.

A prendre en considération lors de l'entretien de la robinetterie et de douchettes:

- On doit seulement utiliser les produits de nettoyage qui sont formellement prévus pour ce domaine.
- Aucun contact avec l'application de nettoyeurs contenant de l'acide chlorhydrique, de l'acide formique ou de l'acide acétique qui peuvent causer de considérables détériorations.
- Les nettoyeurs à base d'acide phosphorique, aussi, ne sont pas à utiliser sans réserves.
- Le mélange de nettoyeurs en général n'est pas autorisé.
- L'utilisation de produits de nettoyage récurants et des ustensiles comme des frottoirs, des éponges à récurer et des torchons microfibrés est exclue.
- Les conseils d'entretien des producteurs de nettoyeurs sont à suivre obligatoirement.
- Le nettoyage est à faire correspondre avec le dosage, le temps d'action, spécifique à l'objet et à la nécessité.
- Le dépôt de calcaire est évité par un nettoyage régulier.
- Pour le nettoyage avec produit vaporisé liquide, en aucun cas sur la robinetterie, mais au contraire aspergé sur le chiffon (torchon, éponge) et effectuer comme cela le nettoyage, car les aérosols peuvent pénétrer dans les

ouvertures et fentes de la robinetterie et peuvent provoquer des détériorations.

- Après le nettoyage rincez avec suffisamment d'eau claire pour éliminer les restes de produits attachés.
- L'utilisation d'appareil de nettoyage à vapeur n'est pas autorisée, car les températures importantes peuvent détériorer les produits.

Indications importantes

- Les produits pour le corps comme les savons liquides, les shampooings ou les gels de douche peuvent causer des détériorations.
- Ici aussi on doit: Après l'utilisation rincer soigneusement les restes avec de l'eau.

Conseil de nettoyage

- **Les détériorations imputables à un mauvais entretien ne peuvent être pris en considération par notre garantie.**
- Par l'action d'un nettoyeur sur les revêtements déjà endommagé il se produit une aggravation des dégâts.

Recomendación de limpieza para los productos de Hansgrohe

Hoy en día, las griferías de baño y de cocina así como duchas modernas se componen de materiales muy distintos para satisfacer las exigencias del mercado respecto al diseño y la funcionalidad. Para evitar daños y reclamaciones hay que tener en cuenta ciertos aspectos tanto en el uso como en su limpieza.

Para el cuidado de las griferías y las duchas en principio hay que seguir lo siguiente:

- Usar sólo detergentes previstos específicamente para este campo de aplicación.
- No aplicar detergentes que contengan ácido clorhídrico, fórmico o acético porque pueden causar daños importantes.
- Detergentes que contienen ácido fosfórico tampoco pueden ser aplicados ilimitadamente. Por regla general no se deben mezclar detergentes.
- Tampoco se deben utilizar utensilios abrasivos, como son polvos abrasivos, esponjas o paños de microfibra.
- Se tienen que seguir siempre las sugerencias de empleo de los fabricantes de los detergentes.
- La limpieza tiene que ser realizada según la dosificación y el tiempo de actuación, en función del objeto y ajustada a las necesidades específicas del mismo.
- Gracias a una limpieza periódica se pueden evitar los depósitos de cal.
- No conviene rociar el detergente en ningún caso sobre la grifería sino sobre los textiles y ejecutar la limpieza así, porque el líquido puede entrar en aperturas o hendiduras de la grifería y causar daños.
- Después de la limpieza hay que aclarar con suficiente agua para eliminar completamente el resto de detergente.
- La utilización de limpiadores a vapor no está permitida, las altas temperaturas pueden dañar los productos.

Indicaciones importantes

- Los residuos de productos de aseo como jabón líquido, champú y gel de ducha pueden dañar también los materiales.
- Por lo que también se deberá prestar atención a lo siguiente: aclarar con abundante agua después del uso.
- Con materiales ya dañados la acción de detergentes incrementará el desgaste de estos.
- **Los componentes con superficies dañadas deberán cambiarse, en otro caso se corre el peligro de lesionarse.**
- Los daños que resulten de un uso inadecuado no están incluidos en nuestra garantía.

Limited Consumer Warranty

This product has been manufactured and tested to the highest quality standards by Hansgrohe, Inc. ("Hansgrohe"). This warranty is limited to Hansgrohe products that are purchased by a consumer in the United States or Canada after March 1, 1996, and installed in either in the United States or in Canada.

WHO IS COVERED BY THE WARRANTY

This warranty extends to the original purchaser only. This warranty is non-transferable.

WHAT IS COVERED BY THE WARRANTY

The warranty covers only your Hansgrohe manufactured product. Hansgrohe warrants this product against defects in material or workmanship as follows:

Hansgrohe will replace at no charge for parts only or, at its option, replace any product or part of the product that proves defective because of improper workmanship and/or material, under normal installation, use, service and maintenance. If Hansgrohe is unable to provide a replacement and repair is not practical or cannot be made in timely fashion, Hansgrohe may elect to refund the purchase price in exchange for the return of the product.

LENGTH OF WARRANTY

Replacement or repaired parts of products will be covered for the term of this warranty, as stated in the following two sentences. If you are a consumer who purchased the product for use primarily for personal, family or household purposes, this warranty extends for as long as you own the product and the home in which the product is originally installed. If you purchased the product for use primarily for any other purpose, including, without limitation, a commercial purpose, this warranty extends only (i) for 1 year, with respect to Hansgrohe & Commercial products, and (ii) for 5 years, with respect to Axor products.

THIS WARRANTY DOES NOT COVER, AND HANSGROHE WILL NOT PAY FOR:

- A. Conditions, malfunctions or damage not resulting from defects in material or workmanship.
- B. Conditions, malfunctions or damage resulting from (1) normal wear and tear, improper installation, improper maintenance, misuse, abuse, negligence, accident or alteration; (2) the use of abrasive or caustic cleaning agents or "no-rinse" cleaning products, or the use of the product in any manner contrary to the product instructions; or (3) conditions in the home such as excessive water pressure or corrosion.
- C. Labor and other expenses for disconnection, deinstallation, or return of the product for warranty service (including but not limited to proper packaging and shipping costs), or for installation or reinstallation of the product.
- D. Accessories, connected materials and products, or related products not manufactured by Hansgrohe.
- E. Any Hansgrohe or Axor product sold for display purposes.
- F. Rubbed Bronze finish is subject to a 3-year limited warranty. Chrome and all PVD finishes are covered by the limited lifetime warranty.
- G. Hansgrohe Water Filtration System is subject to a 1-year limited warranty. Warranty does not include replacement filters.

TO OBTAIN WARRANTY PARTS OR INFORMATION

Contact your Hansgrohe retailer, or contact Technical Service at:

Hansgrohe, Inc.
1492 Bluegrass Lakes Parkway
Alpharetta, GA 30004
Toll-free 800-334-0455

In requesting warranty service, you will need to provide:

1. The sales receipt or other evidence of the date and place of purchase.
2. A description of the problem.
3. Delivery of the product or the defective part, postage prepaid and carefully packed and insured, to:

Hansgrohe, Inc.
1492 Bluegrass Lakes Parkway
Alpharetta, GA 30004
Toll-free 800-334-0455

When warranty service is completed, any repaired or replacement product or part will be returned to you postage prepaid.

EXCLUSIONS AND LIMITATIONS

REPAIR OR REPLACEMENT (OR, IN LIMITED CIRCUMSTANCES, REFUND OF THE PURCHASE PRICE) AS PROVIDED UNDER THIS WARRANTY IS THE EXCLUSIVE REMEDY OF THE PURCHASER. HANSGROHE NEITHER ASSUMES NOR AUTHORIZES ANY PERSON TO CREATE FOR IT ANY OTHER OBLIGATION OR LIABILITY IN CONNECTION WITH THIS PRODUCT. HANSGROHE SHALL NOT BE LIABLE TO PURCHASER OR ANY OTHER PERSON FOR ANY INCIDENTAL, SPECIAL OR CONSEQUENTIAL DAMAGES, ARISING OUT OF BREACH OF THIS WARRANTY OR ANY IMPLIED WARRANTY (INCLUDING BUT NOT LIMITED TO ANY IMPLIED WARRANTY OF MERCHANTABILITY).

Some States do not allow the exclusion or limitation of incidental or consequential damages, so the above limitation or exclusion may not apply to you. This warranty gives you specific legal rights, and you may also have other rights that vary from state to state.

TO THE EXTENT PERMITTED BY LAW, ANY IMPLIED WARRANTIES OF MERCHANTABILITY AND FITNESS FOR A PARTICULAR PURPOSE, ARE LIMITED TO THE DURATION OF THE EXPRESS WARRANTY.

Some states do not allow limitations on how long an implied warranty may last, so the above limitations may not apply to you. You may be required by law to give us a reasonable opportunity to correct or cure any failure to comply before you can bring any action in court against us under the Magnuson-Moss Warranty Act.

PRODUCT INSTRUCTIONS AND QUESTIONS

Upon purchase or prior to installation, please carefully inspect your Hansgrohe product for any damage or visible defect. Prior to installing, always carefully study the enclosed instructions on the proper installation and the care and maintenance of this product. If you have questions at any time about the use, installation or performance of your Hansgrohe product, or this warranty, please write us or call us toll-free at 800-334-0455.

hansgrohe

Hansgrohe, Inc. • 1490 Bluegrass Lakes Parkway • Alpharetta, GA 30004
Tel. 770-360-9880 • Fax 770-360-9887

www.hansgrohe-usa.com