

Product Service / Warranty



Croma 3jet / Croma 2jet

28573001 / 28570001

28573003 / 28570003



Croma 1jet

28511001 / 28511003



Croma Variojet

28513001 / 28513003

hansgrohe

Croma 3jet

28573001 / 28573003

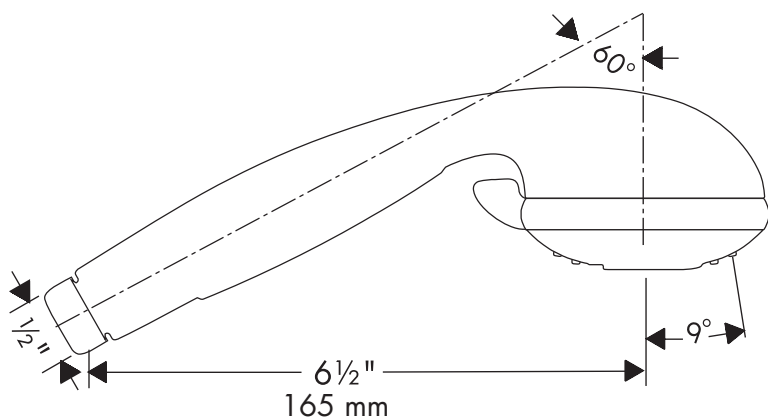
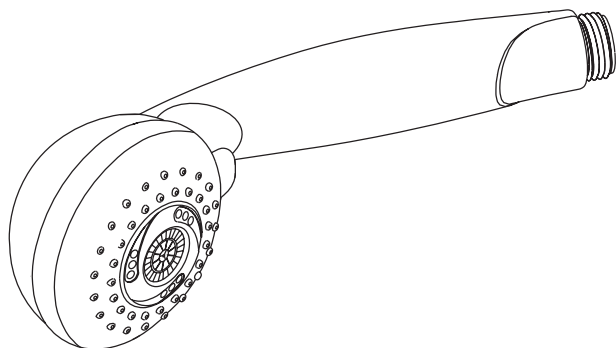

Normal spray
Jet de pluie
Chorro de lluvia



Soft spray
Jet doux aéré
Chorro espumoso



Massage jet
Jet de massage
Chorro masaje

Croma 2jet

28570001 / 28570003

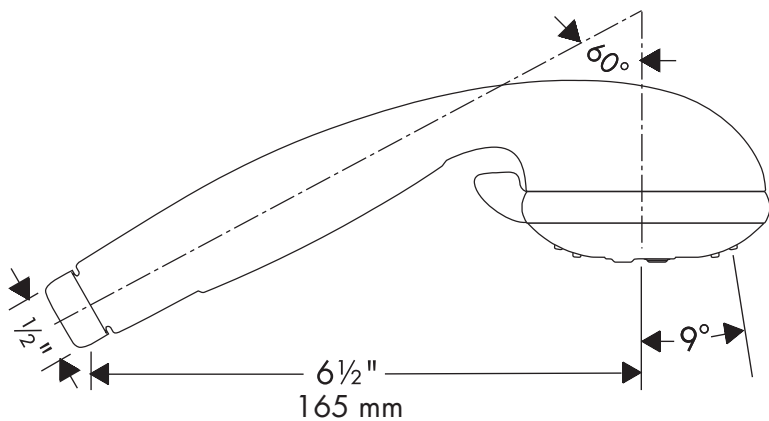
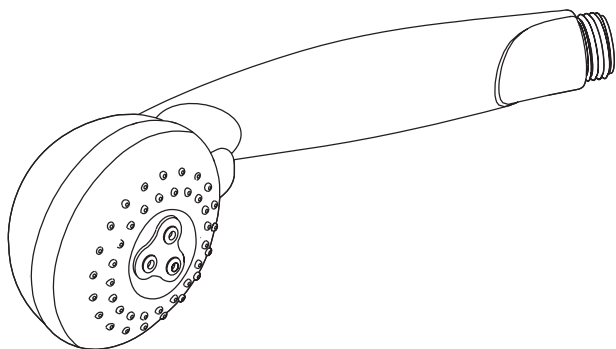

Normal spray
Jet de pluie
Chorro de lluvia



Turbo spray
Jet de turbo
Chorro turbo

Croma 1jet

28511001 / 28511003

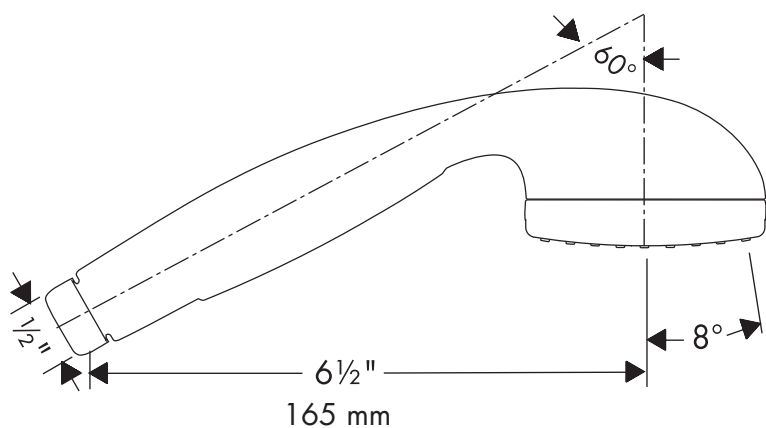
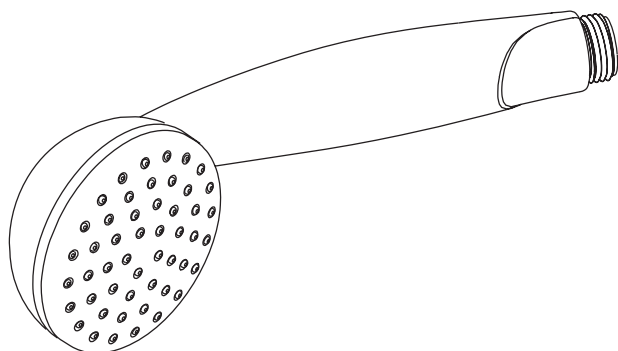

Normal spray
Jet de pluie
Chorro de lluvia

Croma Variojet

28513001 / 28513003

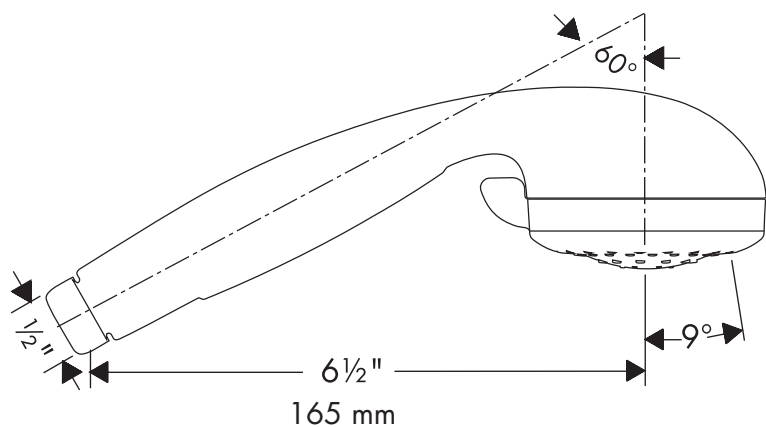
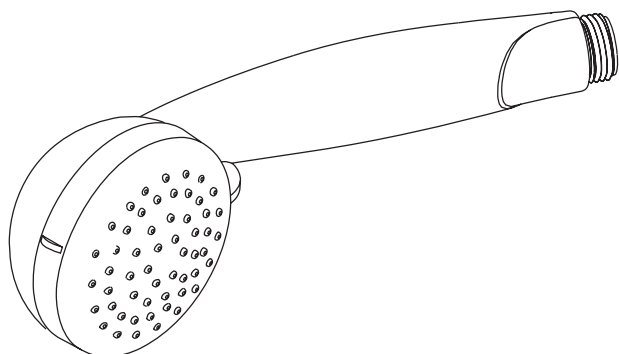

Normal spray
Jet de pluie
Chorro de lluvia



Vario spray
Jet de vario
Chorro vario

Technical Data

Operating pressure: max. 90 psi / max. 6 bar
Recommended operating pressure: 15 - 60 psi / 1 - 4 bar
Hot water temperature: max. 140 °F / max. 60 °C

Note to users in Massachusetts: The maximum output temperature of the shower valve can be no higher than 112°F.

Informations techniques

Pression de service autorisée: max. 90 psi
Pression de service conseillée: 15 - 60 psi
Température max. d'eau chaude: max. 140 °F

Datos técnicos

Presión en servicio: max. 90 psi
Presión recomendada en servicio: 15 - 60 psi
Temperatura del agua caliente: max. 140 °F

Croma 3jet 28573001

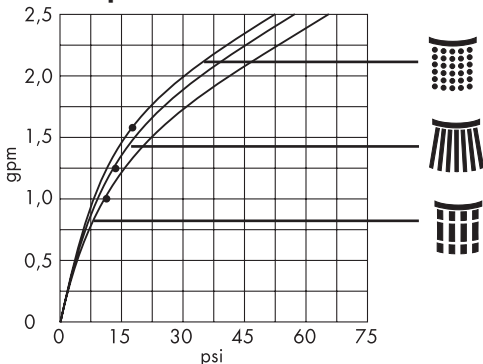

Croma 1jet 28511001

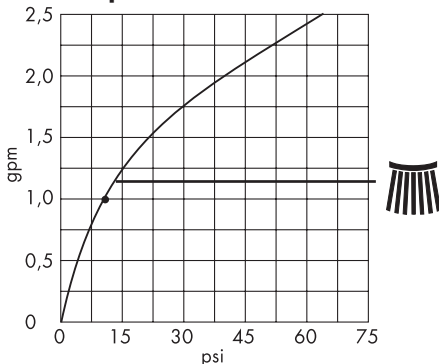

Croma 2jet 28570001

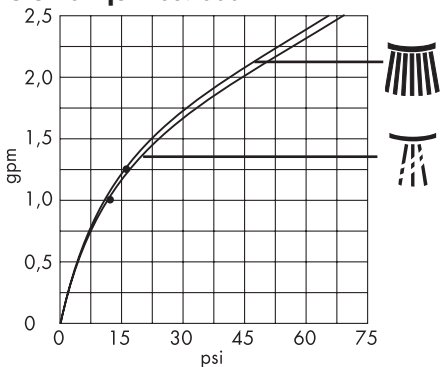

Croma Variojet 28513001

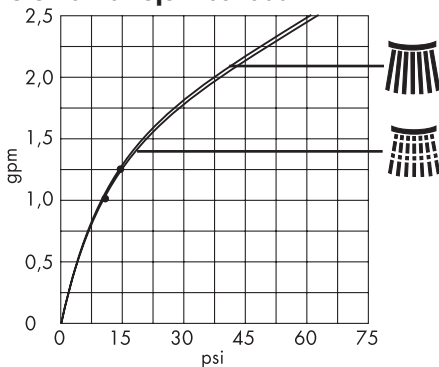

From ● the function is guaranteed.

A partir de ● le fonctionnement est garanti.

A partir de ● está garantizado el funcionamiento.

Assembly / Montage / Montaje

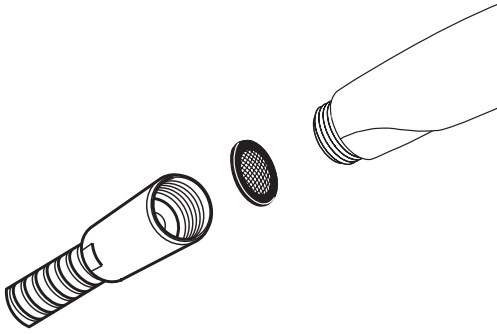

The mesh washer must be insert to protect the hand shower against incoming dirt by pipework. Incoming dirt leads to defects or/and can damage parts of the hand shower; such caused faults voids all liability and guarantee claims.

Le joint à filtre fourni avec la douchette à main doit être installé afin de retenir des impuretés du système de conduites. Ceux-ci pourraient influencer le fonctionnement de ce produit et même endommager des pièces mobiles. Des réclamations à la suite de l'usage de la douchette sans joint-tamis de hansgrohe ne peuvent pas faire partie de notre garantie.

La junta de filtración que se suministra con la teleducha evita que las partículas de suciedad procedentes de las tuberías lleguen a la teleducha. Debe colocarse entre el flexo y la teleducha. Infiltraciones de suciedad deterioran el funcionamiento de la teleducha y pueden causar daños en el interior de la misma que no están cubiertas por la garantía de Hansgrohe.

Croma 3jet 28573003

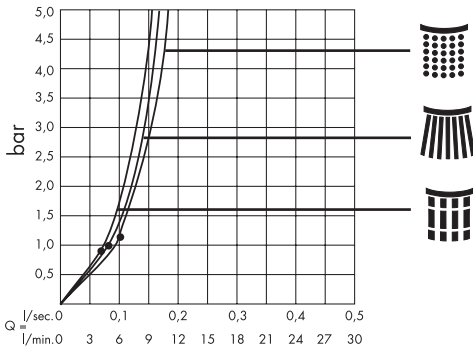

Croma 2jet 28570003

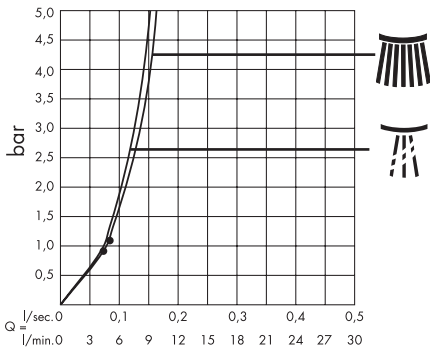

Croma 1jet 28511003

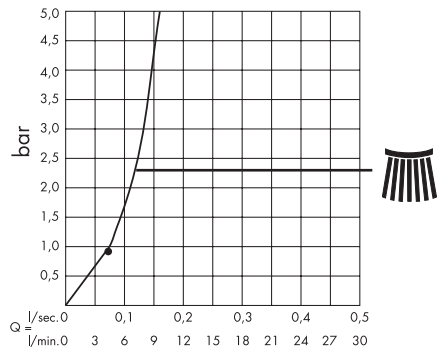

Croma Variojet 28513003

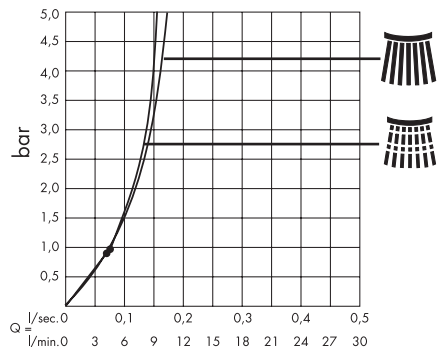

Cleaning instructions:

Clean with a liquid domestic cleaner or with soap suds.

Afterwards rinse with clear water and polish with a cloth.

Do not use any cleaning agents containing acid or scouring agents.

Damage caused by improper treatment is not subject to our guarantee.

Conseils d'entretien:

Nettoyer les surfaces avec un produit d'entretien ménager ou un savon liquide.

Rincer à l'eau claire et polir avec un chiffon doux.

Ne pas utiliser un produit d'entretien à base d'acide ou de poudre à récurer.

Les détériorations imputables à un mauvais entretien ne peuvent être pris en considération par notre garantie.

Entrenimiento:

Las superficies pueden limpiarse con productos de limpieza líquidos o con agua jabonosa. (Tener en cuenta las instrucciones de uso del fabricante de detergentes.)

A continuación aclarar con abundante agua y pulir con una gamuza.

No utilizar productos de limpieza que contengan ácidos, vinagre o que sean abrasivos.

No nos responsabilizaremos si los desperfectos se producen a causa de un manejo inadecuado.

Limited Lifetime Consumer Warranty

This product has been manufactured and tested to the highest quality standards by Hansgrohe, Inc. („Hansgrohe“). This warranty is limited to Hansgrohe products which are purchased by a consumer in the United States after March 1, 1996, and installed in either the United States or Canada.

WHO IS COVERED BY THE WARRANTY

This warranty extends to the original consumer purchaser only.

WHAT IS COVERED BY THE WARRANTY

This warranty covers only your Hansgrohe manufactured product. Hansgrohe warrants this product against defects in material or workmanship as follows: Hansgrohe will repair at no charge for parts only or, at its option, replace any product or part of the product which proves defective because of improper workmanship and/or material, under normal installation, use, service and maintenance. If Hansgrohe is unable to provide a replacement and repair is not practical or cannot be timely made, Hansgrohe may elect to refund the purchase price in exchange for the return of the product.

LENGTH OF WARRANTY

Replacement or repaired parts of products will be covered for the term of this warranty as stated in the following two sentences. If you are a consumer who purchased the product for use primarily for personal, family, or household purposes, this warranty extends for as long as you own the product and the home in which the product is installed. If you purchased the product for use primarily for any other purpose, including, without limitation, a commercial purpose, this warranty extends only (i) for 1 year, with respect to Interaktiv and Retroaktiv products, and (ii) for 5 years, with respect to AXOR, ShowerPower and Pharo products.

THIS WARRANTY DOES NOT COVER, AND HANSGROHE WILL NOT PAY FOR:

- A. Conditions, malfunctions or damage not resulting from defects in material or workmanship.
- B. Conditions, malfunctions or damage resulting from (1) improper installation, improper maintenance, misuse, abuse, negligence, accident or alteration, or (2) the use of abrasive or caustic cleaning agents or „no rinse“ cleaning products, or the use of the product in any manner contrary to the product instructions.
- C. Labor or other expenses for the disconnection or return of the product for warranty service, or for installation or reinstallation of the product.
- D. Accessories or related products not manufactured by Hansgrohe.

TO OBTAIN WARRANTY SERVICE

Contact your Hansgrohe retailer, or write to Technical Service at:

Hansgrohe Inc.
1492 Bluegrass Lakes Parkway
Alpharetta GA 30004

Or, call Hansgrohe toll-free at (800) 334-0455.

In requesting warranty service, you will need to provide

1. The sales receipt or other evidence of the date and place of purchase.
2. A description of the problem.
3. Delivery of the product or the defective part, postage prepaid and carefully packed and insured, to Hansgrohe Inc. 1492 Bluegrass Lakes Parkway, Alpharetta, Georgia 30004, Attention: Technical Service, if required by Hansgrohe.

When warranty service is completed, any repaired or replacement product or part will be returned to you postage prepaid.

EXCLUSIONS AND LIMITATIONS

REPAIR OR REPLACEMENT (OR, IN LIMITED CIRCUMSTANCES, REFUND OF THE PURCHASE PRICE) AS PROVIDED UNDER THIS WARRANTY IS THE EXCLUSIVE REMEDY OF THE PURCHASER. HANSGROHE NEITHER ASSUMES NOR AUTHORIZES ANY PERSON TO CREATE FOR IT ANY OBLIGATION OR LIABILITY IN CONNECTION WITH THIS PRODUCT.

HANSGROHE SHALL NOT BE LIABLE TO PURCHASER OR ANY PERSON FOR ANY INCIDENTAL, SPECIAL, OR CONSEQUENTIAL DAMAGES, ARISING OUT OF BREACH OF THIS WARRANTY OR ANY IMPLIED WARRANTY (INCLUDING MERCHANTABILITY).

Some States do not allow the exclusion or limitation of incidental or consequential damages, so the above limitation or exclusion may not apply to you.

This warranty gives you specific legal rights, and you may have other rights which vary from State to State.

You may be required by law to give us a reasonable opportunity to correct or cure any failure to comply before you can bring any action in court against us under the Magnuson-Moss Warranty Act.

PRODUCT INSTRUCTIONS AND QUESTIONS

Upon purchase or prior to installation, please carefully inspect your Hansgrohe product for any damage or visible defect. Prior to installing, always carefully study the enclosed instructions on the proper installation and the care and maintenance of the product. If you have questions at any time about the use, installation, or performance of your Hansgrohe product, or this warranty, please call or write to us at the toll-free number and address printed above.

hansgrohe

Hansgrohe Inc. 1490 Bluegrass Lakes Parkway Alpharetta GA 30004
Phone 770 360 9880 Internet www.Hansgrohe-USA.com

09/2008
9.08781.03