

# Installation / Warranty

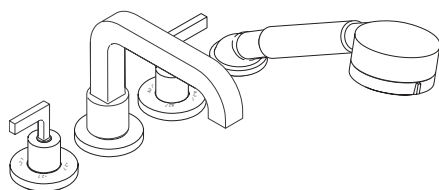

**Citterio**  
39454XX1

**AXOR**<sup>®</sup>  
hansgrohe

# Axor Citterio four-hole roman tub set 39454XX1

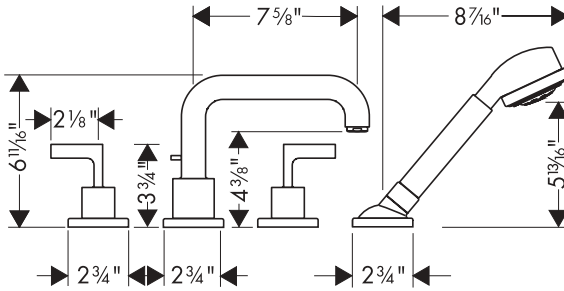

## Technical Data

Flow rate @ 45 psi	6.0 gpm per side
Handshower	2.5 gpm max.
Maximum water pressure	145 psi
Recommended water pressure:	14.5 - 75 psi
Recommended hot water temp.:	120°F - 140°F*

\*Some municipalities limit the maximum water temperature from the water heater to 120° or below. Please know and follow all applicable local codes when setting the temperature on the water heater.

## Installation Considerations

- Roman tub rough 13444181 must be installed, and the finished deck surface must be complete before this trim kit can be installed.
- Backflow preventer cartridge 94146000 is included with this kit, and must be used to provide protection from back siphonage. It is already installed on the 94148000 inner Secu-flex hose.

**The 13444181 roman tub rough is listed by IAPMO.**

## Installation Instructions

**The water supply must be turned off at the main prior to installation of this kit.**

- Remove the plastic plaster shields from the valves and the spout tee. Use a phillips head screwdriver to remove the screws from the white plastic handle snap connectors. Remove the snap connectors.

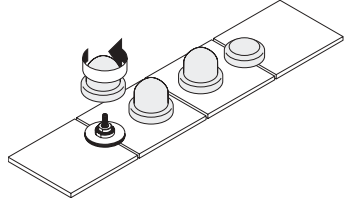

- Press the diverter firmly into place in the spout tee. Remove the cold cartridge.

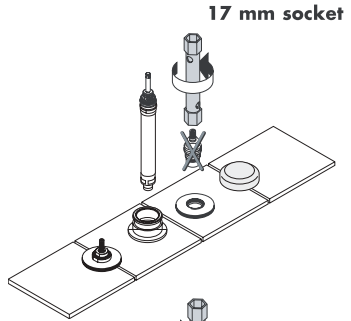

- Install the new cold cartridge included with the trim kit.

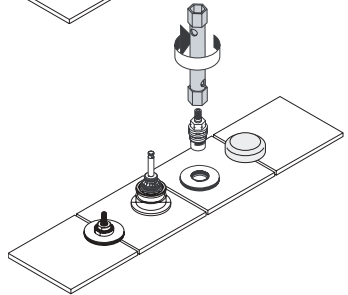

- Pull upward on the handshower holder plaster shield. Pull the outer Secu-flex hose completely away from the deck. Unscrew the white plastic winged nut from the bottom of the Secu-flex hose. Put the outer hose away in a safe location. Be extremely careful to prevent the high pressure hose from falling back beneath the tub.

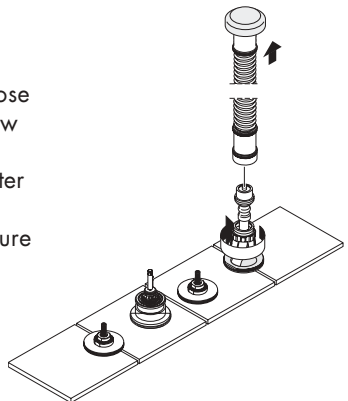

- Remove the brass plug from the end of the high pressure hose. Attach the chrome inner Secu-flex hose. Use the enclosed Hansgrohe Color towelette to clean and lubricate the inner hose. Have a co-worker use the towelette to clean and lubricate the ends of the outer hose. If the towelette is missing, use a soft cloth sprayed with a silicon lubricant.

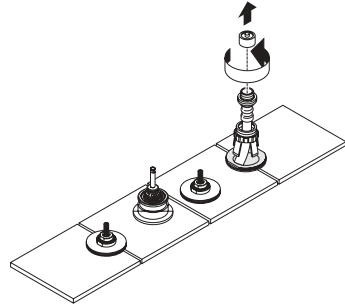

- Disassemble the handshower holder as shown in the diagram. Feed the inner hose through the outer hose. Secure the outer hose at the bottom with the white plastic winged nut. Remove the plaster shield. Compress the outer hose so that the hose end connection can be grasped.

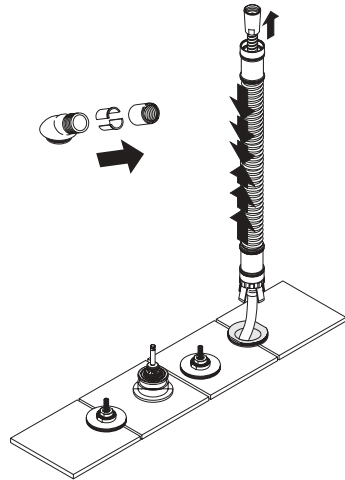

- Feed the hose end connection through the handshower holder. Snap the two halves of the white plastic retainer over the inner hose. Slide the finished hose retaining ring over the end of the hose and the white plastic hose retainer. Screw it into the handshower holder.

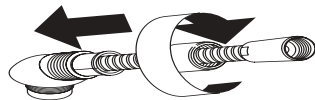

- Lower the handshower holder onto the handshower tee, feeding the hose assembly under the tub. The hole on the rear of the handshower holder should go over the positioning pin on the handshower holder tee. Install the handshower holder escutcheon over the handshower holder. Screw it down over the tee.

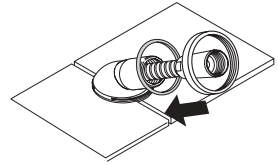

- Screw the sub-escutcheon rings onto the hot and cold valves..
- Press the hot and cold escutcheons over the sub-escutcheon rings.

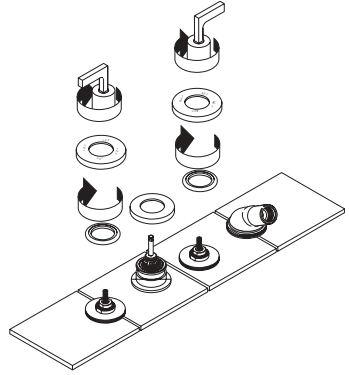

- Inspect the handles, making sure that they are aligned properly.

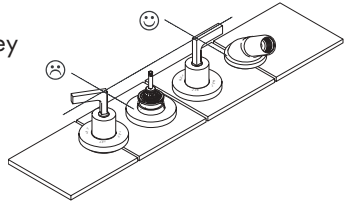

- If the handle is not straight, remove it from the valve by grasping the barrel and turning it counter clockwise.

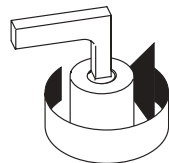

- Use a phillips head screwdriver to loosen the screw inside the handle assembly 3 complete turns clockwise.

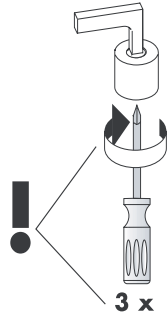

- Pull upward on the lever to remove it. Turn it approximately 60°. Reinsert it. Tighten the screw.

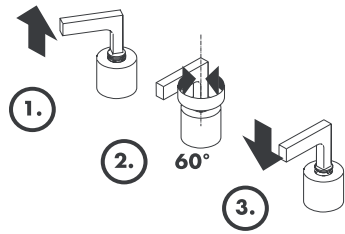

- Reinstall the handle.

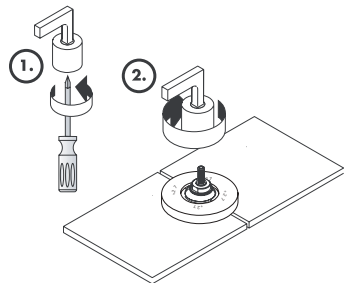

- Place the spout over the diverter assembly. Insert the diverter knob and tighten. Tighten the set screw, using the enclosed 3 mm allen wrench.

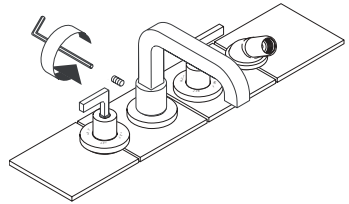
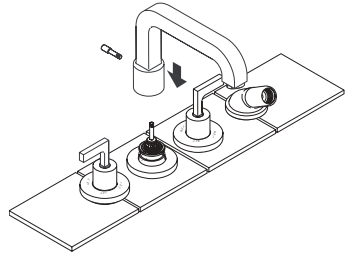

- Pull outward on the inner Secu-flex hose. Install a screen washer in the hose end connector. Install the handshower.

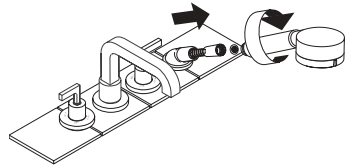

- Guide the handshower back into the handshower holder.

## User Instructions

- Turn the left handle to obtain hot water, the right handle to obtain cold water.
- When the water comes on, it will come through the spout. Pull the diverter lever up to divert the water to the handshower. When the water is turned off, the diverter will automatically reset to the spout position.

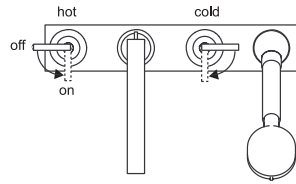

## Troubleshooting

Problem	Possible Cause	Solution
Water drips from spout when unit is turned off.	Valve cartridge is dirty or faulty.	Remove and clean valve cartridge. Replace if faulty.
Water leaks from under spout.	Set screw is too tight. Diverter is not straight.	Loosen set screw slightly Remove and reinstall diverter, pressing diverter evenly into place.
Handspray does not retract easily.	Diverter is faulty. Inner Secu-flex hose should be cleaned and lubricated.	Replace diverter. Pull out handshower. Clean and lubricate inner Secuflex hose with cloth sprayed with silicon sealant.
When handspray is pulled out, handshower holder comes off of tub.	Handshower holder not installed correctly.	Reinstall handshower holder according to installation instruction.

## Replacement Parts

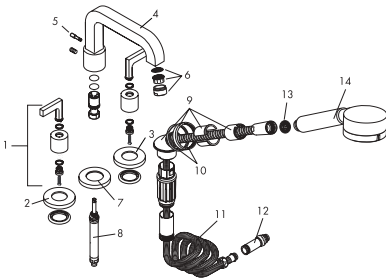

1	handle	39294XX0
2	hot escutcheon	96771XX0
3	cold escutcheon	96772XX0
4	spout	96773XX0
5	diverter knob	96774XX0
6	areator	13956XX0
7	spout escutcheon	96236XX0
8	diverter	96777XX0
9	handshower holder	96433XX0
10	handshower holder escutcheon	96237XX0
11	inner Secu-flex hose	94148000
12	backflow preventer cartridge	94146000
13	screen washer	94146000
14	Uno handshower	38850XX1

XX = color  
 00 = chrome  
 42 = platinum



# Cleaning Recommendation for Hansgrohe Products

Modern faucetry and shower products utilize a combination of materials to comply with the needs of the market with regard to design and functionality.

To avoid damage, it is necessary to use some caution when cleaning. Damage caused by improper treatment is not covered under the Hansgrohe warranty.

## Cleaning Materials for Faucets and Showers

- To remove lime scale, use only products made specifically for that purpose. Always follow the manufacturer's instructions when using.
- Do not use cleaners that contain hydrochloric, formic, acetic, or phosphoric acids, as these will cause considerable damage to finishes and to plastic components.
- Never mix cleaning materials.
- Never use cleaners containing abrasives. Do not use abrasive cleaning cloths, pads, or sponges.

## Cleaning Procedures

- Clean your faucets and shower products as and when required. Regular cleaning will prevent scale buildup and water spotting.
- Follow the label instructions. Do not allow any cleaner to remain on the product for longer than necessary.
- When using spray cleaners, spray first onto a sponge or cloth – do not spray directly onto the product.
- After cleaning, rinse thoroughly with clear water to remove any cleaner residue.

## Important

- Soap and shampoo residue can also cause damage to the product. Rinse well with clean water after use.
- If the surface is already damaged, harsh cleaning materials will cause further damage.

# Limited Lifetime Consumer Warranty

This product has been manufactured and tested to the highest quality standards by Hansgrohe, Inc. ("Hansgrohe"). This warranty is limited to Hansgrohe products which are purchased by a consumer in the United States after March 1, 1996, and installed in either the United States or Canada.

## WHO IS COVERED BY THE WARRANTY

This warranty extends to the original consumer purchaser only.

## WHAT IS COVERED BY THE WARRANTY

The warranty covers only your Hansgrohe manufactured product. Hansgrohe warrants this product against defects in material or workmanship as follows: Hansgrohe will repair at no charge for parts or labor or, at its option, replace any product or part of the product which proves defective because of improper workman ship and/or material, under normal installation, use, service and maintenance. If Hansgrohe is unable to provide a replacement and repair is not practical or cannot be timely made, Hansgrohe may elect to refund the purchase price in exchange for the return of the product.

## LENGTH OF THE WARRANTY

Replacement of repaired parts of products will be covered for the term of this warranty as stated in the following two sentences. If you are a consumer who purchased the product for use primarily for personal, family or household purposes, this warranty extends for as long as you own the product and the home in which the product is installed. If you purchased the product for use primarily for any other purpose, including, without limitation, a commercial purpose, this warranty extends only (i) for 1 year with respect to Interaktiv products, and (ii) for 5 years, with respect to Axor and Pharo products.

**THIS WARRANTY DOES NOT COVER, AND HANSGROHE WILL NOT PAY FOR:**

- A. Conditions, malfunctions or damage not resulting from defects in material or workmanship.
- B. Conditions, malfunctions, or damage resulting from (1) improper installation, improper maintenance, misuse, abuse, negligence, accident or alteration, or (2) the use of abrasive or caustic cleaning agents or “no rinse” cleaning products, or the use of the product in any manner contrary to the product instructions.
- C. Labor and other expenses for disconnection or return of the product for warranty service, or for installation or reinstallation of the product.
- D. Accessories or related products not manufactured by Hansgrohe.

**TO OBTAIN WARRANTY SERVICE**

Contact your Hansgrohe retailer, or write to Technical Service at:

Hansgrohe Inc.  
1492 Bluegrass Lakes Parkway  
Alpharetta GA 30004

Or call Hansgrohe toll-free at (800) 334 0455.

In requesting warranty service, you will need to provide:

- 1. The sales receipt or other evidence of the date and place of purchase.
- 2. A description of the problem.
- 3. Delivery of the product or the defective part, postage prepaid, and carefully packed and insured, to Hansgrohe Inc. 1492 Bluegrass Lakes Parkway, Alpharetta Georgia 30004, Attention: Technical Service, if required by Hansgrohe.

When warranty service is completed, any repaired or replacement product or part will be returned to you postage prepaid.

**EXCLUSIONS AND LIMITATIONS  
REPAIR OR REPLACEMENT (OR, IN LIMITED CIRCUMSTANCES, REFUND OF THE PURCHASE PRICE) AS PROVIDED UNDER THIS WARRANTY IS THE EXCLUSIVE REMEDY OF THE PURCHASER. HANSGROHE NEITHER ASSUMES NOR AUTHORIZES ANY PERSON TO CREATE FOR IT ANY OTHER OBLIGATION OR LIABILITY IN CONNECTION WITH THIS PRODUCT.**

**HANSGROHE SHALL NOT BE LIABLE TO PURCHASER OR ANY OTHER PERSON FOR ANY INCIDENTAL, SPECIAL, OR CONSEQUENTIAL DAMAGES, ARISING OUT OF A BREACH OF THIS WARRANTY OR ANY IMPLIED WARRANTY (INCLUDING MERCHANTABILITY).**

Some States do not allow the exclusion or limitation of incidental or consequential damages, so the above limitation or exclusion may not apply to you.

This warranty gives you specific legal rights, and you may also have other rights which vary from state to state.

You may be required by law to give us a reasonable opportunity to correct or cure any failure to comply before you can bring any action in court against us under the Magnuson-Moss Warranty Act.

**PRODUCT INSTRUCTIONS AND QUESTIONS**

Upon purchase or prior to installation, please carefully inspect your Hansgrohe product for any damage or visible defect. Prior to installing, always carefully study the enclosed instructions on the proper installation and the care and maintenance of this product. If you have questions at any time about the use, installation or performance of your Hansgrohe product, or this warranty, please call or write to us at the toll-free number and address provided above.



**Hansgrohe Inc.**  
1490 Bluegrass Lakes Parkway  
Alpharetta GA 30004  
770 360 9880  
website: [www.hansgrohe-USA.com](http://www.hansgrohe-USA.com)