

Installation Instructions / Warranty

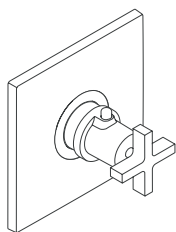

Axor Citterio
39384XX1
39387XX1

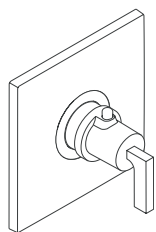

Axor Citterio
39385XX1
39386XX1

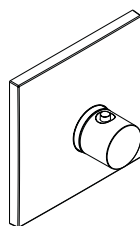

Axor Massaud
18743001
18747001

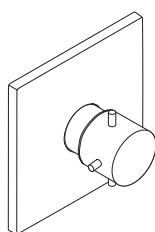

Axor Starck X
10385XX1
10386XX1

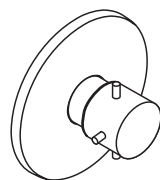

Axor Starck
10375XX1
10379XX1

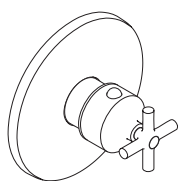

Axor Terrano
37375XX1
37379XX1

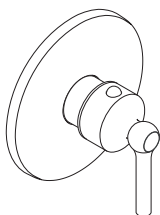

Axor Terrano
37475XX1
37374XX1

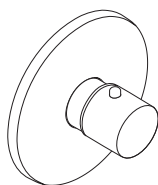

Axor Steel
35375801
35379801

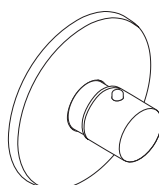

Axor Uno
38475XX1
38379XX1

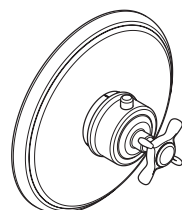

Axor Montreux
16810XX1
16815XX1

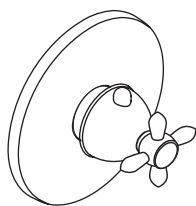

Axor Carlton
17475XX1
17379XX1

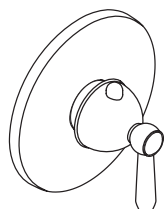

Axor Carlton
17375XX1
17374XX1

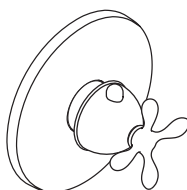

Axor Phoenix
17384XX1
17387XX1

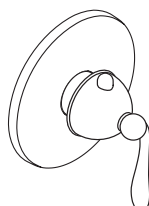

Axor Phoenix
17385XX1
17386XX1

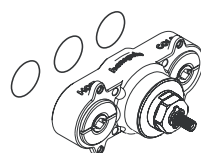

Upgrade Kit
06800XX3

hangrohe

Ecostat / EcoMax Trim Kits

Axor Starck

10375XX1 Ecostat
10379XX1 EcoMax

Axor Starck X

10385XX1 Ecostat
10386XX1 EcoMax

Axor Citterio - Cross Handle

39384XX1 Ecostat
39387XX1 EcoMax

Axor Citterio - Lever Handle

39385XX1 Ecostat
39386XX1 EcoMax

Axor Massaud

18743001 Ecostat
18747001 EcoMax

Axor Steel

35375801 Ecostat
35379801 EcoMax

Axor Uno

38475XX1 EcoStat
38379XX1 EcoMax

Axor Montreux

16810XX1 Ecostat
16815XX1 EcoMax

Axor Terrano - Cross Handle

37375XX1 Ecostat
37379XX1 EcoMax

Axor Terrano - Lever Handle

37475XX1 Ecostat
37374XX1 EcoMax

Axor Carlton - Cross Handle

17475XX1 Ecostat
17379XX1 EcoMax

Axor Carlton - Lever Handle

17375XX1 Ecostat
17374XX1 EcoMax

Axor Phoenix - Cross Handle

17384XX1 Ecostat
17387XX1 EcoMax

Axor Phoenix - Lever Handle

17385XX1 Ecostat
17386XX1 EcoMax

EcoMax Upgrade Kit

06800XX3

Installation Considerations

- For best results, Hansgrohe recommends that this trim kit be installed by a licensed, professional plumber.
- Prior to the installation of this trim kit, rough valve 15373181 or 15374181 must be installed. The finished wall must be complete.
- The water must be turned off at the main before beginning installation.
- The Ecostat™ and EcoMax™ thermostats incorporate isolation stops and check valves.

These trim kits are compatible with the new style rough, manufactured after 10/2003. Note the more rectangular opening.

These trim kits are not compatible with the older-style rough, manufactured before 10/2003. The opening is too wide to be covered by the escutcheon.

ok!

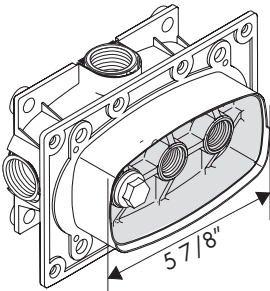

no!

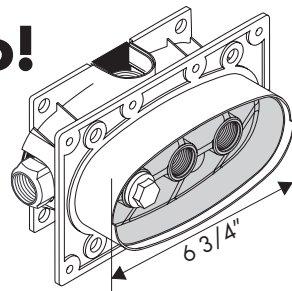

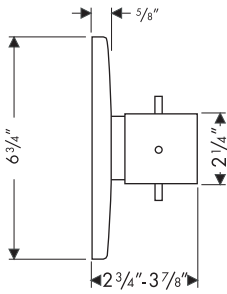

10375XX1
10379XX1

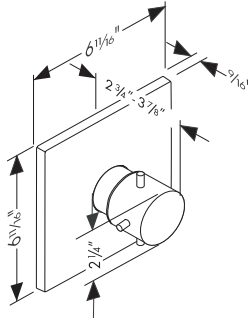

10385XX1
10386XX1

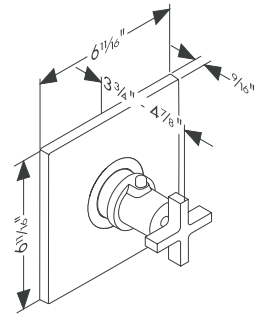

39384XX1
39387XX1

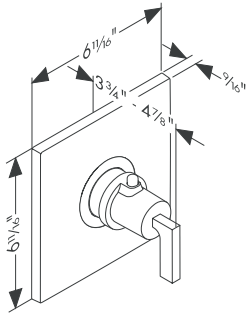

39385XX1
39386XX1

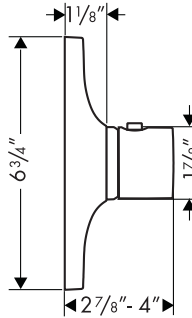

18743001
18747001

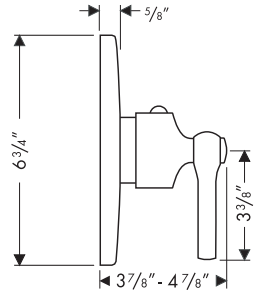

37475XX1
37374XX1

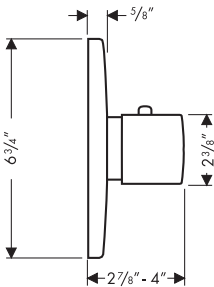

35375801
35379801

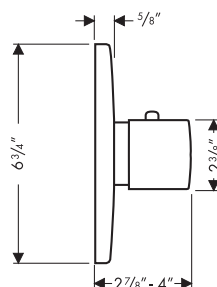

38475801
38379801

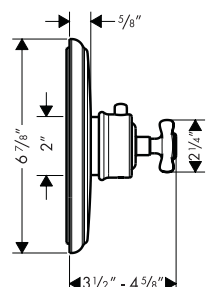

16810XX1
16815XX1

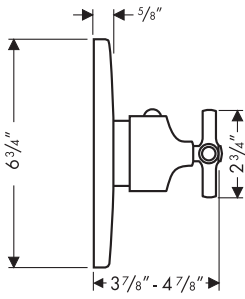

37375XX1
37379XX1

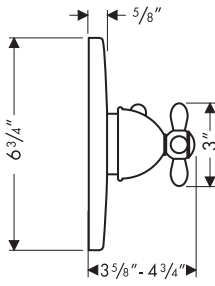

17475XX1
17379XX1

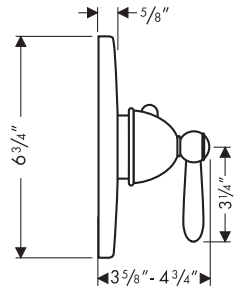

17375XX1
17374XX1

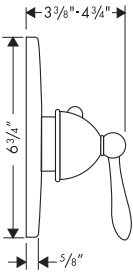

17384XX1
17387XX1

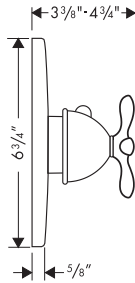

17385XX1
17386XX1

Installation

Remove the flush insert and the o-rings. **Do not discard the hex-head screws.**

Cut the installation box so that it is nearly flush with the finished wall. Seal around the installation box with waterproof bathroom sealant.

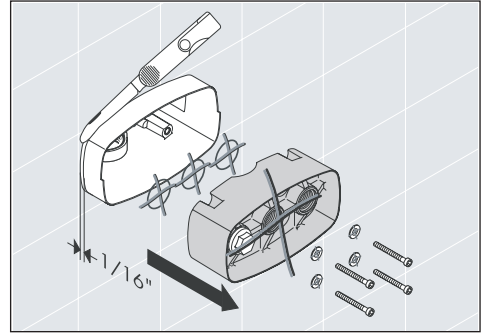

Install the new o-rings included with the thermoelement. Install the thermoelement, using the saved hex-head screws. Turn on the water and check for leaks.

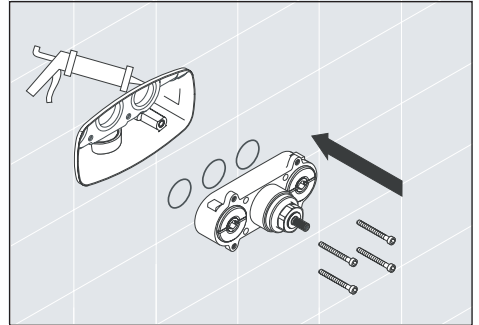

Install the trim carrier plate with the enclosed carrier screws.

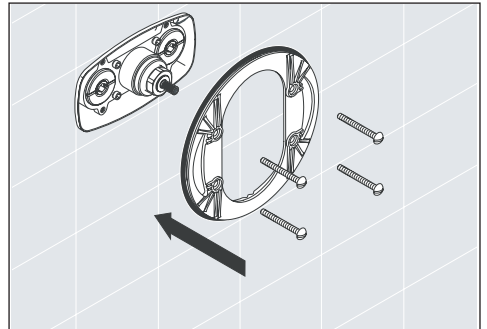

Install the trim sleeve with the indexing mark at the 12:00 position.

Push the escutcheon firmly over the carrier plate - the sealing ring around the carrier plate will hold it in place. Install the handle adapter with the screw.

Install and justify the handle.

indexing
mark

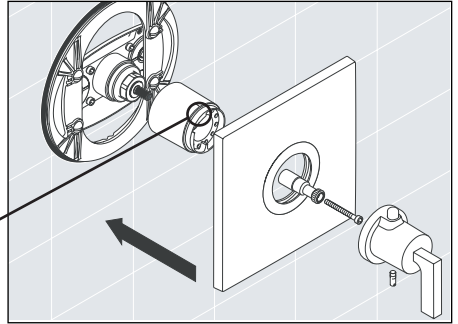

Massaud only:

Install the two pieces of the sleeve – the safety set and the cover. Orient the safety set as shown in the illustration.

Install the escutcheon.

Install the handle adapter and screw. Install and justify the handle.

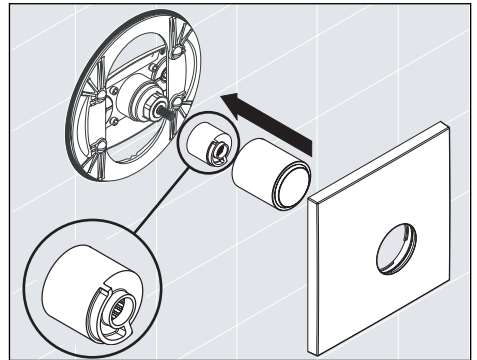

Justify the handle

Tools required: small slot-head screwdriver, thermometer

Loosen, but do not remove, the set screw on the handle.

Turn the water on to one of the functions. Place the thermometer in the water stream. Turn the handle until the water is 100° F. Turn the water off, without moving the thermostatic mixer handle.

Remove the thermostatic mixer handle. Replace it so that the safety stop override button is at the 12:00 position. Tighten the set screw.

Reverse the Thermoelement

If the Ecostat™ or EcoMax™ outputs both hot and cold water, but the water does not mix, the supply lines may have been crossed, or the rough valve or thermoelement may have been installed upside down. This is easily remedied .

Turn the water off to the valve – **do not use the stops on the thermoelement.** Remove, reverse, and reinstall the entire thermoelement.

User Instructions

Turn the handle clockwise to make the water cooler, counter-clockwise to make it warmer.

The handle will stop at the 100° safety stop. To obtain water hotter than 100°, push the safety stop override button and continue turning the handle counter-clockwise.

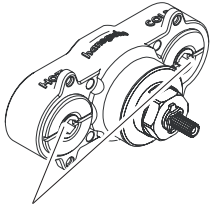

stops

Using the isolation stops

Turn off the water using the isolation stops on the EcoStat or EcoMax instead of turning off the water to the whole house when making minor repairs to the shower.

Use an 8 mm allen wrench to turn the isolation valve clockwise to close the stop. Be sure to close both the hot and cold stops before removing the cartridge, etc. Turn a volume control valve on to depressurize the system and to confirm that the water is off.

The water must be turned off at the main before the entire thermosteement can be removed.

EcoMax™ Upgrade Kit 06800XX3

Installation Considerations

The EcoMax™ upgrade kit contains an EcoMax™ function block, trim sleeve, and screws. It is used to upgrade an existing EcoStat™ installation.

Install the EcoMax™ Upgrade Kit

Turn the water off to the valve before proceeding. Do not use the stops on the thermosteement.

Remove the trim. Set it aside in a safe place.

Remove the EcoStat™ thermosteement and the o-rings.

Install the EcoMax™ thermosteement and o-rings. Use the screws provided with the EcoMax™ upgrade kit.

Turn on the water to the valve and check for leaks.

Replace the trim as shown in the previous instructions EXCEPT use the included EcoMax™ trim sleeve.

Justify the handle.

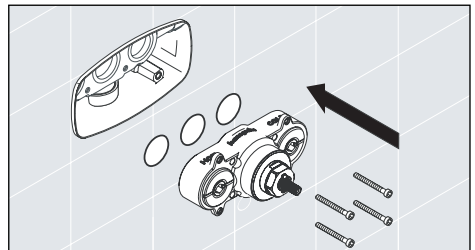
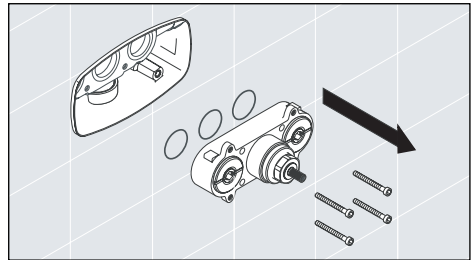

Set the High Temperature Limit Stop (optional)

IMPORTANT: Many municipalities have codes limiting the maximum discharge temperature of a shower valve to 110° F or less. Please know and follow all applicable local codes when setting the high temperature limit stop.

Tools Required:

Thermometer

3 mm Allen wrench (included with trim kit)

Turn the hot and cold supplies to the valve on.

Turn the water on using the handle.

Use the 3 mm Allen wrench to loosen the set screw on the bottom of the handle. Remove the handle.

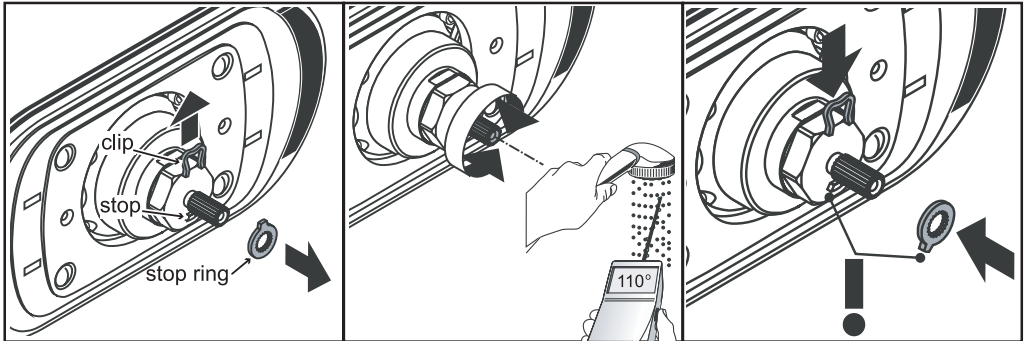

Remove the clip and stop ring from the thermostatic cartridge stem. Put them in a safe place.

Turn the thermostatic mixer stem with your fingers, clockwise to make the water cooler, counter-clockwise to make the water warmer. Turn the stem until the water coming out is the desired maximum high temperature – 110° in most areas.

Reinstall the stop ring so that it is against the stop. Reinstall the clip.

Justify and reinstall the handle.

Replacement Parts

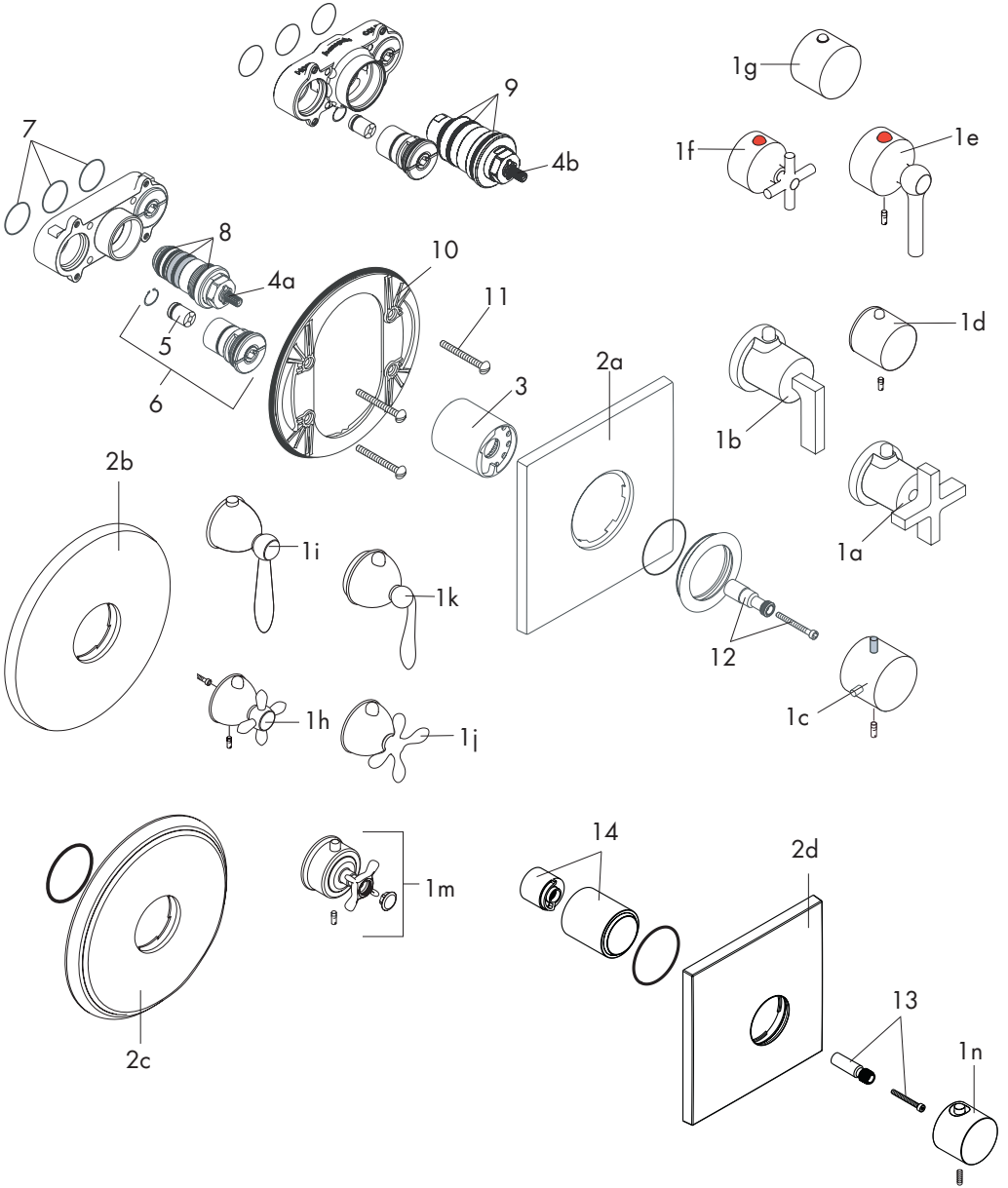

1a	Citterio cross handle	39994XX1	5	check valve	95033000
1b	Citterio lever handle	39391XX1	6	isolation stop	95036000
1c	Starck handle	10391XX1	7	seals	96364000
1d	Steel handle	35391801	8	seals	95037000
1e	Terrano handle, lever	37391XX1	9	seals	96636000
1f	Terrano handle, cross	37994XX1	10	carrier plate	96447000
1g	Uno handle	38391XX1	11	carrier plate screw	96454001
1h	Carlton handle, cross	17994XX1	12	handle adapter	97108000
1i	Carlton handle, lever	17391XX1	13	Massaud handle adapter	98701001
1j	Phoenix handle, cross	96631XX1	14	Massaud sleeve	98734001
1k	Phoenix handle, lever	96791XX1			
1m	Montreux handle	16594XX1			
1n	Massaud handle	18097000	XX = color		
2a	Escutcheon, square	96749XX0	00 = chrome		
2b	Escutcheon, round	96452XX0	09 = chrome/gold		
2c	Escutcheon, Montreux	98648XX0	42 = platinum		
2d	Escutcheon, Massaud	98678000	80 = steel		
3	EcoStat™ sleeve	95032XX0	81 = satinox		
	EcoMax™ sleeve	96635XX0	82 = brushed nickel		
4a	EcoStat™ cartridge	94282000	83 = polished nickel		
4b	EcoMax™ cartridge	96633000	93 = polished brass		

Cleaning Recommendation for Hansgrohe Products

Modern faucetry and shower products utilize a combination of materials to comply with the needs of the market with regard to design and functionality.

To avoid damage, it is necessary to use some caution when cleaning. Damage caused by improper treatment is not covered under the Hansgrohe warranty.

Cleaning Materials for Faucets and Showers

- To remove lime scale, use only products made specifically for that purpose. Always follow the manufacturer's instructions when using.
- Do not use cleaners that contain hydrochloric, formic, acetic, or phosphoric acids, as these will cause considerable damage to finishes and to plastic components.
- Never mix cleaning materials.
- Never use cleaners containing abrasives. Do not use abrasive cleaning cloths, pads, or sponges.

Cleaning Procedures

- Clean your faucets and shower products as and when required. Regular cleaning will prevent scale buildup and water spotting.
- Follow the label instructions. Do not allow any cleaner to remain on the product for longer than necessary.
- When using spray cleaners, spray first onto a sponge or cloth – do not spray directly onto the product.
- After cleaning, rinse thoroughly with clear water to remove any cleaner residue.

Important

- Soap and shampoo residue can also cause damage to the product. Rinse well with clean water after use.
- If the surface is already damaged, harsh cleaning materials will cause further damage.

Limited Lifetime Consumer Warranty

This product has been manufactured and tested to the highest quality standards by Hansgrohe, Inc. ("Hansgrohe"). This warranty is limited to Hansgrohe products which are purchased by a consumer in the United States after March 1, 1996, and installed in either the United States or Canada.

WHO IS COVERED BY THE WARRANTY

This warranty extends to the original consumer purchaser only.

WHAT IS COVERED BY THE WARRANTY

This warranty covers only your Hansgrohe manufactured product. Hansgrohe warrants this product against defects in material or workmanship as follows: Hansgrohe will repair at no charge for parts only or, at its option, replace any product or part of the product which proves defective because of improper workmanship and/or material, under normal installation, use, service and maintenance. If Hansgrohe is unable to provide a replacement and repair is not practical or cannot be timely made, Hansgrohe may elect to refund the purchase price in exchange for the return of the product.

LENGTH OF WARRANTY

Replacement or repaired parts of products will be covered for the term of this warranty as stated in the following two sentences. If you are a consumer who purchased the product for use primarily for personal, family, or household purposes, this warranty extends for as long as you own the product and the home in which the product is installed. If you purchased the product for use primarily for any other purpose, including, without limitation, a commercial purpose, this warranty extends only (i) for 1 year, with respect to Interaktiv and Retroaktiv products, and (ii) for 5 years, with respect to AXOR, ShowerPower and Pharo products.

THIS WARRANTY DOES NOT COVER, AND HANSGROHE WILL NOT PAY FOR:

- Conditions, malfunctions or damage not resulting from defects in material or workmanship.
- Conditions, malfunctions or damage resulting from (1) improper installation, improper maintenance, misuse, abuse, negligence, accident or alteration, or (2) the use of abrasive or caustic cleaning agents or "no rinse" cleaning products, or the use of the product in any manner contrary to the product instructions.
- Labor or other expenses for the disconnection or return of the product for warranty service, or for installation or reinstallation of the product.

D. Accessories or related products not manufactured by Hansgrohe.

TO OBTAIN WARRANTY SERVICE

Contact your Hansgrohe retailer, or write to Technical Service at:

Hansgrohe Inc.
1492 Bluegrass Lakes Parkway
Alpharetta GA 30004

Or, call Hansgrohe toll-free at (800) 334-0455.

In requesting warranty service, you will need to provide

1. The sales receipt or other evidence of the date and place of purchase.
2. A description of the problem.
3. Delivery of the product or the defective part, postage prepaid and carefully packed and insured, to Hansgrohe Inc. 1492 Bluegrass Lakes Parkway, Alpharetta, Georgia 30004, Attention: Technical Service, if required by Hansgrohe.

When warranty service is completed, any repaired or replacement product or part will be returned to you postage prepaid.

EXCLUSIONS AND LIMITATIONS

REPAIR OR REPLACEMENT (OR, IN LIMITED CIRCUMSTANCES, REFUND OF THE PURCHASE PRICE) AS PROVIDED UNDER THIS WARRANTY IS THE EXCLUSIVE REMEDY OF THE PURCHASER. HANSGROHE NEITHER ASSUMES NOR AUTHORIZES ANY PERSON TO CREATE FOR IT ANY OBLIGATION OR LIABILITY IN CONNECTION WITH THIS PRODUCT.

HANSGROHE SHALL NOT BE LIABLE TO PURCHASER OR ANY PERSON FOR ANY INCIDENTAL, SPECIAL, OR CONSEQUENTIAL DAMAGES, ARISING OUT OF BREACH OF THIS WARRANTY OR ANY IMPLIED WARRANTY (INCLUDING MERCHANTABILITY).

Some States do not allow the exclusion or limitation of incidental or consequential damages, so the above limitation or exclusion may not apply to you.

This warranty gives you specific legal rights, and you may have other rights which vary from State to State.

You may be required by law to give us a reasonable opportunity to correct or cure any failure to comply before you can bring any action in court against us under the Magnuson-Moss Warranty Act.

PRODUCT INSTRUCTIONS AND QUESTIONS

Upon purchase or prior to installation, please carefully inspect your Hansgrohe product for any damage or visible defect. Prior to installing, always carefully study the enclosed instructions on the proper installation and the care and maintenance of the product. If you have questions at any time about the use, installation, or performance of your Hansgrohe product, or this warranty, please call or write to us at the toll-free number and address printed above.

hansgrohe

Hansgrohe, Inc. • 1490 Bluegrass Lakes Parkway • Alpharetta, GA 30004
Tel. 770 360-9880 • Fax 770 360 9887

www.hansgrohe-USA.com