

### Features

- Brass construction.
- Brass valve bodies.
- Quarter-turn washerless ceramic disc valves.
- Single-hole mounting.
- Right-side lever handle.
- Traditional styling.
- Aquifer Water Filtration System.
- 7-5/8" (194 mm) high-arch rotating spout.
- 3" (76 mm) spout reach.
- Includes Aquifer® filter head and hose assemblies.
- 1.6 gal/min (6.1 l/min) maximum flow rate.

### Required Accessories

K-201 Premium Refill Filter Cartridge

or

K-202 Premium Refill Filter Cartridge



ADA

### Codes/Standards

ASME A112.18.1/CSA B125.1

NSF 61

NSF 372

DOE - Energy Policy Act 1992

ADA

ICC/ANSI A117.1







All applicable US Federal and State material regulations

### KOHLER® Faucet Lifetime Limited Warranty

See website for detailed warranty information.

### Available Color/Finishes

*Color tiles intended for reference only.*

Color	Code	Description
	SN	Vibrant® Polished Nickel
	PB	Vibrant® Polished Brass
	G	Brushed Chrome
	BN	Vibrant® Brushed Nickel
	VS	Vibrant® Stainless
	BV	Vibrant® Brushed Bronze
	2BZ	Oil-Rubbed Bronze

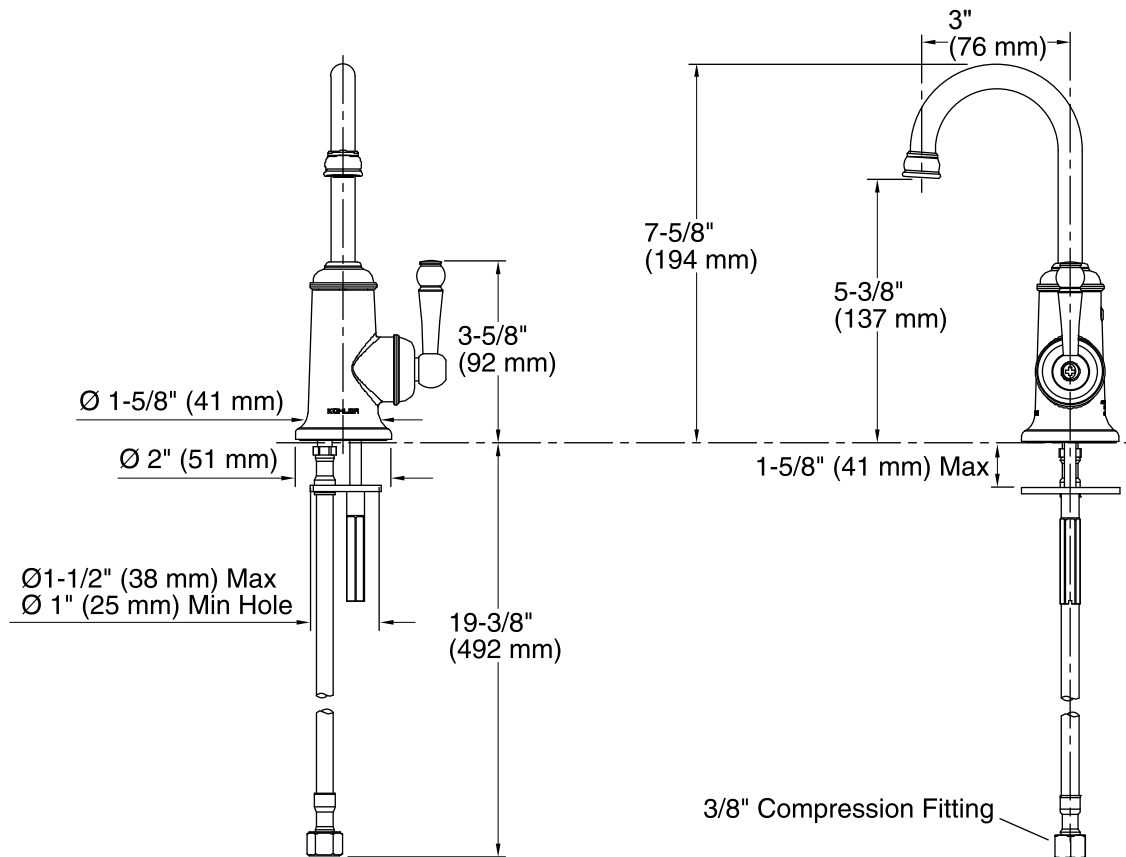

### Technical Information

All product dimensions are nominal.

Spout reach: 3" (76 mm)

### Faucet:

Flow rate: 1.6 gal/min (6.1 l/min)

### Notes

Install this product according to the installation guide.

**NOTICE:** Do not use this product with instant hot water systems or reverse osmosis (RO) filtration systems. Product damage will result.

ADA compliant when installed to the specific requirements of these regulations.