

# KOHLER®

## INSTALLATION INSTRUCTIONS

# CENTERSET BIDET FAUCETS

### BEFORE YOU BEGIN

#### NOTES

- Shut off the main water supply.
- Observe local plumbing codes.
- If possible, install this faucet before installing the bidet.
- Inspect the supply tubing for damage. Replace as necessary.
- Kohler Co. reserves the right to make revisions in the design of faucets without notice, as specified in the Price Book.

#### TOOLS AND MATERIALS RECOMMENDED

- Plumbers Putty
- Thread sealant
- Adjustable or open end wrench
- Assortment of hex wrenches

#### TOOLS AND MATERIALS OPTIONAL

- Hacksaw or tubing cutter
- Pipe wrench
- Pliers
- Supply tubes
- Shut-off valves
- P-trap

### INSTALLATION

- Apply a 1/4" diameter ring of plumbers putty around the underside edge of the faucet body.
- Insert the faucet through the top of the bidet.
- Install the dished washer and locknut to the faucet body shank. Securely hand-tighten the locknut.
- Remove any excess plumbers putty.

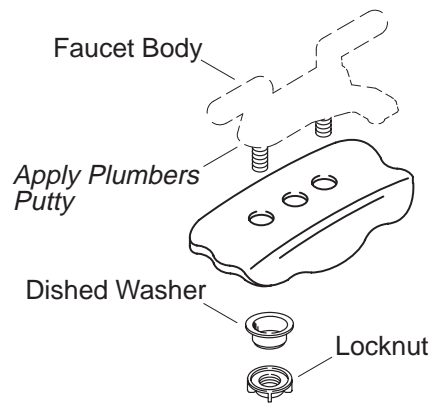

**DETERMINE YOUR DRAIN STYLE AND FOLLOW THE APPROPRIATE INSTALLATION STEPS.**

**DRAIN (CP AND PB FINISHES)**

- Remove the protective seal from the flange.
- Apply a 1/2" diameter ring of plumbers putty around the underside of the flange. Insert the flange into the bidet drain hole.
- Assemble the gasket (tapered side up) and washer to the flange, and partially thread the nut to the flange. **Do not** fully tighten the nut at this time.
- Install the body washer and body to the flange, and wrench-tighten.
- Position the body so the seal hole is facing toward the back of the bidet.
- Hand-tighten the nut.
- Remove any excess plumbers putty.

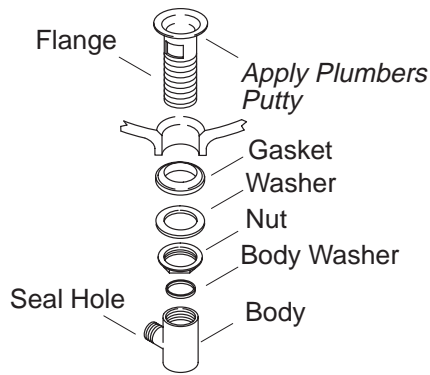

**DRAIN (OTHER FINISHES)**

- Remove the flange from the body.
- Thread the nut completely onto the body.
- Apply a 1/2" diameter ring of plumbers putty to the underside of the drain flange.
- Insert the drain body up into the underside of the bidet drain hole.
- Position the body so the seal hole is facing toward the back of the bidet.
- Thread the flange onto the drain body from the topside of the bidet.
- Securely hand-tighten the nut from the underside of the bidet.
- Remove any excess plumbers putty.

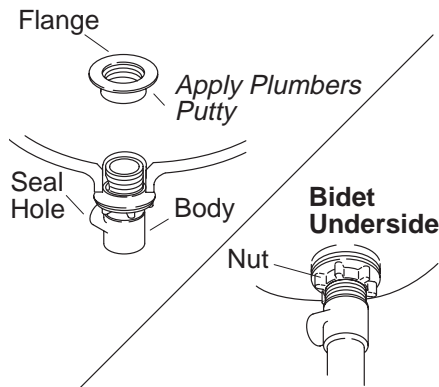

- Assemble the nylon washer, metal washer, and nut onto the long end of the rod.
- Assemble the nylon washer and rubber washer onto the short end of the rod.

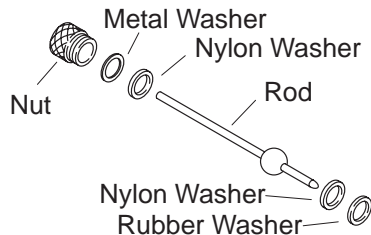

### ALL DRAINS

- Insert the stopper into the flange.
- Remove the body nut from the seal hole.
- Fit the short end of the rod into the body seal hole and **under** the stopper for regular installations; **through** the hole for vandal-resistant installations.
- Loosely secure in place with the body nut.
- Remove and adjust the stopper so the stopper lifts about 3/8" when opened. To adjust, loosen the stopper nut and shorten or lengthen the stopper as needed. Re-tighten the stopper nut.
- Hand-tighten the body nut.
- Apply thread sealant to the tailpiece. Thread the tailpiece into the body and securely hand-tighten.

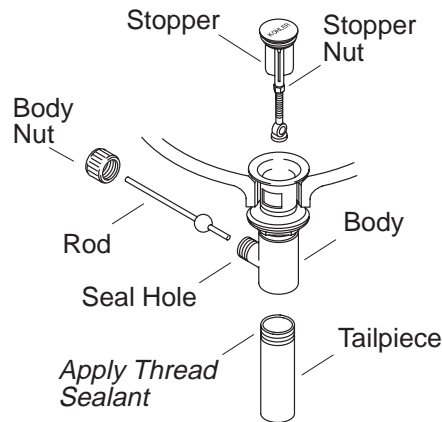

- Slide the clip and the link onto the rod with the thumb screw facing toward the back of the bidet.
- To move the link to the proper position, squeeze the clip and slide it along the rod.
- Push the rod down (open position).

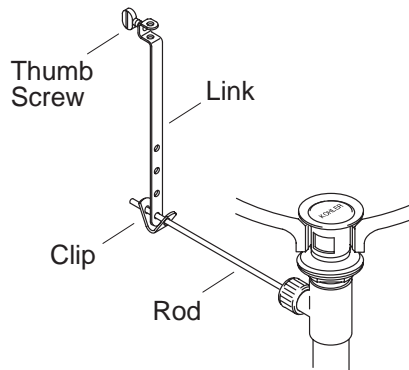

- Slide the faucet lift rod through the hole in the spout and through the hole in the link.
- Tighten the thumb screw on the link so the lift rod knob is 1/2" above the lift rod hole.

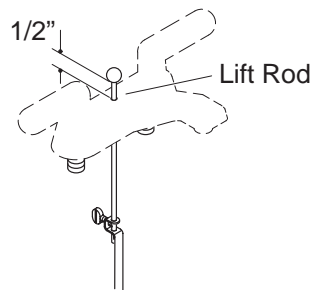

**IF THE BIDET IS NOT INSTALLED, INSTALL IT AT THIS TIME. BE SURE TO FOLLOW ALL INSTRUCTIONS PACKED WITH THE BIDET.**

### SUPPLIES AND STOPS

- Identify your supply connection type. Connect the supply tubes to the faucet inlets and supply stops. (Left is hot – right is cold.)
- Tighten all connections.

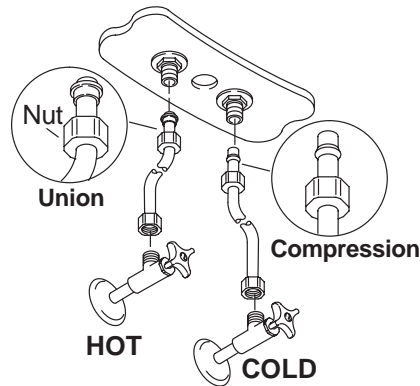

### INSTALLATION CHECKOUT

- Connect the tailpiece and P-trap.
- Ensure that all connections are tight.
- Remove the aerator.
- Open the drain.
- Turn on the main water supply and check for leaks.
- Open both hot and cold valves and run water through the spout to remove any debris. Turn the valves off.
- Reinstall the aerator.

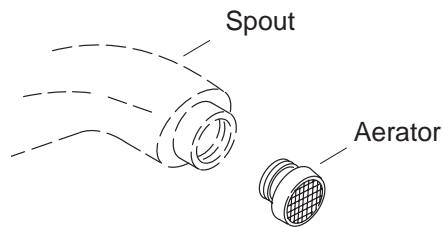

### CALL US FOR HELP – 1-800-4-KOHLER

#### REQUESTING SERVICE

Here's what you need to do if you require service:

First review the installation instructions to ensure correct installation. If you are unable to correct the problem, call our Customer Service Department for direct help. Dial **1-800-4-KOHLER**.