

FEATURES

- 4'
- Cast iron
- Acid resistant enamel finish
- Accepts multiple users in stadiums, arenas, and other high-traffic areas

CODES/STANDARDS APPLICABLE

Specified model meets or exceeds the following:

- ASME/ANSI A112.19.1M
- Energy Policy Act of 1992 (EPACT)
- Canadian Standards Association (CSA)

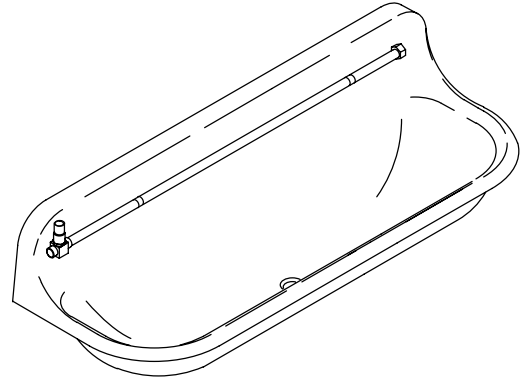

COLORS/FINISHES

- 0 White

Accessories:

- CP Polished Chrome

SPECIFIED MODEL:

Model	Description	Colors/Finishes
K-5056	4' urinal	<input type="checkbox"/> 0 White
Required Accessories		
K-9199	Washdown pipe, 48"	<input type="checkbox"/> CP

PRODUCT SPECIFICATION:

The urinal shall be 4' in length. Urinal shall be made of cast iron with acid resistant enamel finish. Urinal shall accept multiple users in stadiums, arenas, and other high-traffic areas. Urinal shall be Kohler Model K-5056-_____.

PRODUCT INFORMATION

Included Components:	
Wall hangers (2)	64503

Roughing-In Notes
(T) Drain typically 11-7/8".

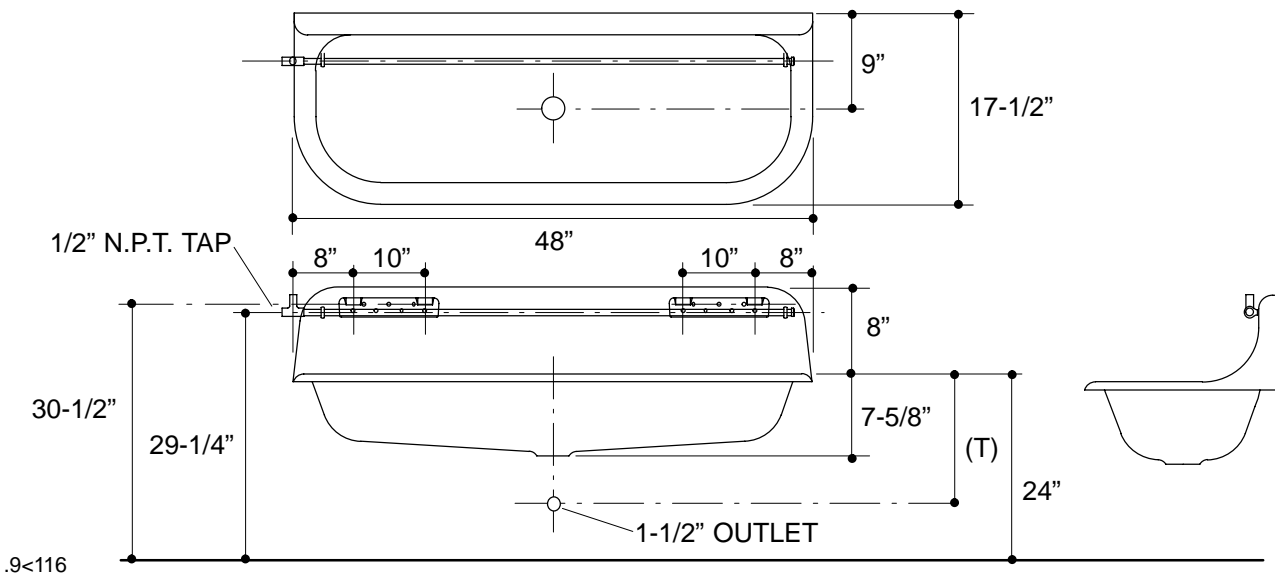

PRODUCT DIAGRAM