

INSTALLATION INSTRUCTIONS

Item#341-PL(Rev. 09/25/2012)

READ AND SAVE THESE INSTRUCTIONS

WARNING! SHUT POWER OFF AT FUSE OR CIRCUIT BREAKER.

AVERTISSEMENT! COUPER LE COURANT AU NIVEAU DES FUSIBLES OU DU DISJONCTEUR.

MOUNTING THE FIXTURE (Fig. 1)

1. Shut off power at the circuit breaker and remove old fixture from ceiling, including the mounting hardware.
2. Carefully unpack your new fixture and lay out all the parts on a clear area. Take care not to lose any small parts necessary for installation.
3. Secure Circular Strap (B) using Screw (D) to the Outlet Box (A). The side of the Circular Strap marked "GND" must face out.
4. Screw Studs (C) into the screw hole of Circular Strap (B).

CONNECTING THE WIRES (Fig. 2)

5. Connect the electrical wires as shown in Fig. 2, making sure that all wire connectors are secured. If your outlet has a ground wire (green or bare copper), connect the fixture's Ground Wire to it. Otherwise, connect the fixture's Ground Wire directly to the circular strap using the Green Screw provided.

FINISHING THE INSTALLATION (Fig. 1)

6. Place Fixture Body (F) into two Studs (C) and secure it tightly using Knurled Knobs (E).
7. Install the PL bulb (H) (Included) in accordance with the fixture's specification. **(DO NOT EXCEED THE MAXIMUM WATTAGE RATING!) (NE PAS DEPASSER LA PUISSANCE NOMINALE MAXIMALE!).**
8. The ballast in each of these models can be replaced by a qualified electrician without cutting of wires and without damage to the housing, trim, decorative elements or carpentry to which the fixture is attached. The ballast and lamp are combined, to replace or install, twist pins into socket as shown Fig 3.
9. Insert Glass Shade (G) into frame of the Fixture Body (F).
10. This fixture is rated for a minimum start temperature of 0 degrees Fahrenheit (-17 degree Celsius).

Your installation is now complete. Return power to the outlet box and test the fixture.

Note: Illustration (Fig. 1) on this manual is for installation purposes only. It may or may not be identical to the fixture purchased.

The color correlated Temperature (CCT) for replacing the enclosed lamp is (2700K).

Note: CFLs contain Mercury (Hg) Dispose of according to Local, State and Federal Law. (www.epa.gov/bulbrecycling).

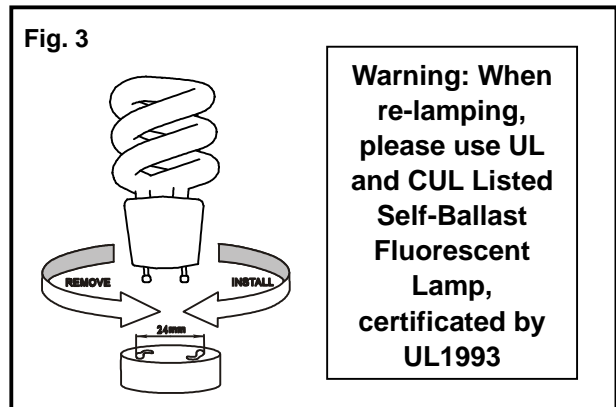
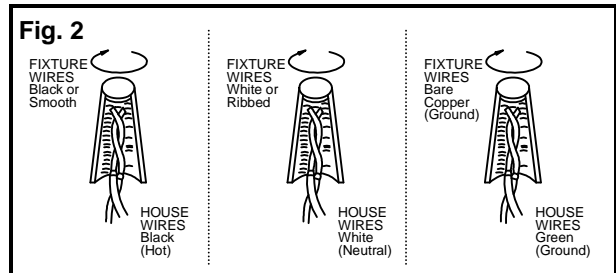
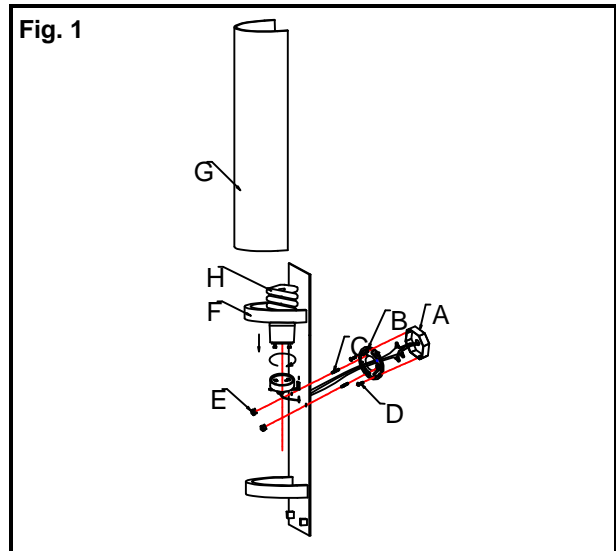

LIMITED 3 YEAR WARRANTY

This Fixture is covered by a Limited 3 year Warranty from the Manufacturer, effective from the date of purchase. This fixture is warranted against defects in the quality of the housing, trims, diffuser, shades, and electrical components. Fixture finishes and/or lamps (bulbs) are expressly excluded from this warranty; refer to bulb manufacturer for lamp warranty.

LA-1004E-A

