

# INSTALLATION INSTRUCTION FOR 830-PL

## For Flush Mount Ceiling Fixtures

### READ AND SAVE THESE INSTRUCTIONS

**WARNING! SHUT POWER OFF AT FUSE OR CIRCUIT BREAKER.**

**AVERTISSEMENT! COUPER LE COURANT AU NIVEAU DES FUSIBLES OU DU DISJONCTEUR.**

#### MOUNTING THE FIXTURE

1. Shut off the power at the fuse box or circuit breaker. If necessary, remove the old fixture, including the mounting hardware.
2. Carefully unpack your new fixture and lay out all the parts on a clear area. Take care not to lose any small parts necessary for installation.
3. Thread the two mounting screws (A) about 1/4" into the pre-drilled holes in the crossbar (B) (part#A-010) spaced the same distance apart as the holes in the ceiling pan (E).
4. Attach the crossbar (B) to the outlet box using the two screws (C) (size:8-32\*1/2"L) from the outlet box. The side of the crossbar marked "GND" must face out.
5. While holding the ceiling pan (E) toward the ceiling, connect the electrical wires as follows.

#### CONNECTING THE WIRES (Fig.2)

6. Connect the black wire from the fixture to the black house (hot) wire. Connect the white wire from the fixture wire to the white (neutral) house wire. Make sure all wire nuts are secured. You may wrap the connections with electrical tape. If your outlet has a ground wire (green or bare copper), connect fixture's ground wire to it. Otherwise connect fixture's ground wire directly to the crossbar using the green screw (D) provided. (Fig.2) Tuck the wire connections neatly into the ceiling junction box as you hold the ceiling pan assembly toward the ceiling.

#### COMPLETING THE INSTALLATION (Fig. 1)

7. Finish mounting the ceiling pan (E) by placing it over both mounting screws (A) so that they protrude through the "keyholes" in the bottom of the pan. Rotate the pan until the screws are in the slots of the "keyholes" and tighten with a screwdriver.
8. Install the light bulb(s) (H) in accordance with the fixture's specifications. **DO NOT EXCEED THE MAXIMUM WATTAGE RATING! (NE PAS DEPASSER LA PUISSANCE NOMINALE MAXIMALE!).**
9. The ballast and bulb are combined, to replace or install, twist pins into socket as shown on Fig.3.
9. Thread the nipple (G) into the ceiling pan (E). Place the glass shade (I) over the ceiling pan (E) allowing the nipple (G) to protrude through the bottom hole in the glass.
10. While holding the glass shade (I), attach the hex nut (J) to the nipple (G), slide bottom cap (K) over the nipple (G) and tighten with finial (L) against ceiling pan (E).
11. This fixture is rated for a minimum start temperature of -17° Celsius.

Your installation is now complete. Return power to the junction box and test the fixture.

**IMPORTANT: FIXTURE SHOULD BE INSTALLED BY A QUALIFIED ELECTRICIAN TO ENSURE PROPER WIRING AND INSTALLATION.**

**note:** CFLs contain Mercury (Hg) Dispose of according to Local, State and Federal Law. ([www.epa.gov/bulbrecycling](http://www.epa.gov/bulbrecycling))

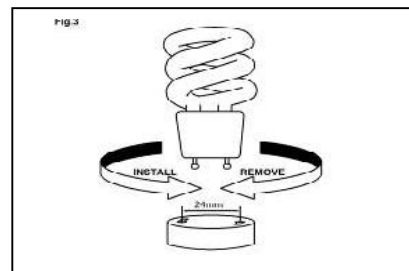
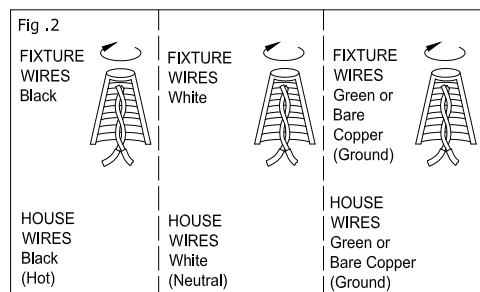
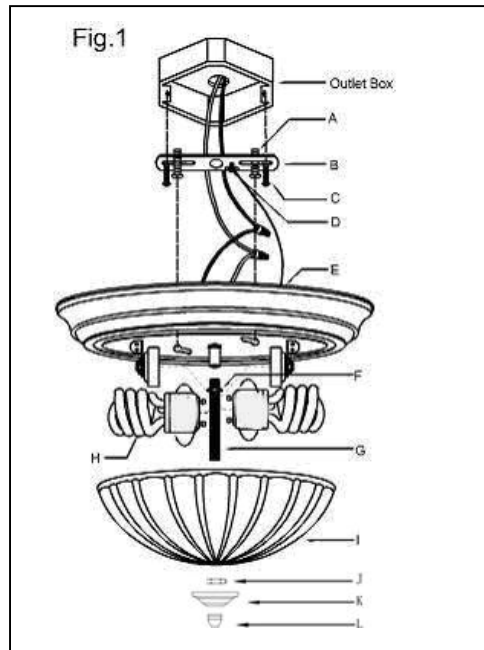

A-010

