



# WING™

A

GEORGE  
KOVACS®

DESIGN

by minkaAire.  
A Minka Group Co.

U.S. Patent(s) Pending

INSTRUCTION MANUAL WARRANTY CERTIFICATE



ENERGY STAR

This product is protected by United States Federal and/or State Law, including Patent, Trademark and/or Copyright laws.

Manual design and all elements of manual design are protected by U.S. Federal and/or State Law, including Patent, Trademark and/or Copyright laws.



The Minka-Aire® warranty is for one (1) year from the date of purchase from an authorized Minka-Aire® dealer. This warranty is only valid to the original purchaser or user against all defects in material and workmanship (light bulbs excluded) for one (1) full year. Additionally, Minka-Aire® warrants the motor only for the lifetime of the Minka Aire ceiling fan (excluding wall controls and electrical components), to the original purchaser or user.

- \* The warranty is voided with the use of any non- Minka-Aire® electrical devices, E.g., wall controls or electrical dimmer switches, etc...
- \* The warranty is void once the original purchaser or user ceases to own the fan or the fan is moved from its original point of installation.
- \* The warranty is void with the use of any hanger bracket (non-Minka Aire or non-fan specific) other than the hanger bracket supplied & installed with this specific fan.

## Warranty Service Information

To obtain warranty service during the warranty period, the purchaser should return the fan with the sales receipt to the original place of purchase. The authorized Minka-Aire® dealer, at its sole discretion, will either repair or replace the fan after verifying the legitimacy of the warranty claim. Replacement is subject to availability of the same model. If the model is unavailable it will be replaced by one of equal value. This is a limited warranty; the original purchaser or user is responsible for the cost of removal and reinstallation of repaired or replacement product.

To obtain the name of the Minka-Aire® authorized dealer nearest you call the Minka-Aire® customer care department at 1-800-307-3267, or contact Minka-Aire® through [www.minkagroup.net](http://www.minkagroup.net) and write to: "Ask Mr. Minka" to answer any questions or if you require assistance.

Date Purchased \_\_\_\_\_ Store Purchased \_\_\_\_\_ Model Number F823 Serial Number \_\_\_\_\_

SAFETY RULES.....	1	FINISHING THE INSTALLATION.....	6
PACKAGE CONTENTS.....	2	OPERATING THE REMOTE CONTROL/WALL CONTROL .....	7
INSTALLING THE FAN.....	3	CARE OF YOUR FAN.....	8
HANGING THE FAN.....	4	TROUBLESHOOTING.....	9
ELECTRICAL CONNECTIONS.....	5	SPECIFICATIONS.....	10

## ***CONTENTS***



1151 W. Bradford Court, Corona, CA 92882 • For Customer Assistance Call: 1-800-307-3267



Intertek

# 1

## ***SAFETY RULES***

1. Before you begin installing the fan, shut power off at the circuit breaker of the fuse box.
2. Be cautious! Read all instructions and safety information before installing your new fan. Review accompanying assembly diagrams.
3. Make sure that all electrical connections comply with local codes, ordinances, or National Electrical Codes. Hire a qualified electrician or consult a do-it-yourself wiring handbook if you are unfamiliar with installing electrical wiring.
4. Make sure the installation site you choose allows the fan blades to rotate without any obstructions. Allow a minimum clearance of 7 feet from the floor and 18 inches from the tip of the blades to the wall.
5. If you are mounting the fan to a ceiling fan outlet box, use a U.L. Listed metal octagonal outlet box marked "Acceptable for Fan Support". Secure the box directly to the building structure. The outlet box and its support must be able to support the moving weight of the fan (at least 50 pounds) Do not use a plastic box.
6. Caution: To reduce the risk of injury use only the screws provided with the outlet box in conjunction with the lock washers provided with the fan.
7. If you are mounting the fan to a joist, make sure it is able to support the moving weight of the fan (at least 50 pounds).
8. After you install the fan, make sure that all mounting components are secured to prevent the fan from falling.
9. Do not insert anything into the fan blades while the fan is operating.
10. Turn the fan off and wait for the blades to stop completely before proceeding with maintenance or cleaning.

**NOTE:** The important safeguards and instructions appearing in this manual are not meant to cover all possible conditions and situations that may occur. It must be understood that common sense, caution and care are factors which can not be built into this product. These factors must be supplied by the person (s) installing, caring for and operating the unit.

**NOTE:** READ AND SAVE ALL INSTRUCTIONS!

## **WARNING**

**TO REDUCE THE RISK OF FIRE, ELECTRIC SHOCK OR OTHER PERSONAL INJURY, MOUNT FAN ONLY TO A U.L. LISTED OUTLET BOX OR SUPPORTING SYSTEM MARKED ACCEPTABLE FOR FAN SUPPORT AND USE MOUNTING SCREWS PROVIDED WITH THE OUTLET BOX IN CONJUNCTION WITH THE LOCK WASHERS PROVIDED WITH THE FAN. MOST OUTLET BOXES COMMONLY USED FOR FAN SUPPORT OF LIGHTING FIXTURES ARE NOT ACCEPTABLE FOR FAN SUPPORT AND NEED TO BE REPLACED. CONSULT A QUALIFIED ELECTRICIAN IF IN DOUBT.**

**TO REDUCE THE RISK OF PERSONAL INJURY, DO NOT BEND THE BLADE HOLDERS WHILE INSTALLING, BALANCING THE BLADES OR CLEANING THE FAN. DO NOT INSERT FOREIGN OBJECTS BETWEEN ROTATING FAN BLADES.**

**TO REDUCE THE RISK OF FIRE OR ELECTRONIC SHOCK, THIS FAN ONLY CAN USE UC70846T REMOTE CONTROL ONLY.**

2

## PACKAGE CONTENTS

Unpack your fan and check the contents. You should have the following items:

1. Canopy assembly (hanger bracket, canopy and canopy cover)
  2. Extra metal canopy cover
  3. Standard downrod ass'y
  4. Top housing
  5. Fan motor/blades ass'y
  6. Hand held remote + holder + 2 mounting screws + A23 12 volt battery
- A. Mounting hardware:  
#10 x 1.5" Wood screws (2 PCs.)  
#8 x 3/4" Machine screws (2 PCs.)  
Lock washers (2 PCs.)  
4mm star washers (2 PCs.)  
Wire nuts (3 PCs.)  
Washers (2 PCs.)
- B. Soft lint  
C. Cotton gloves

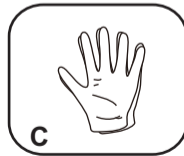
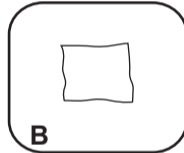
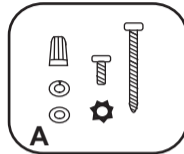
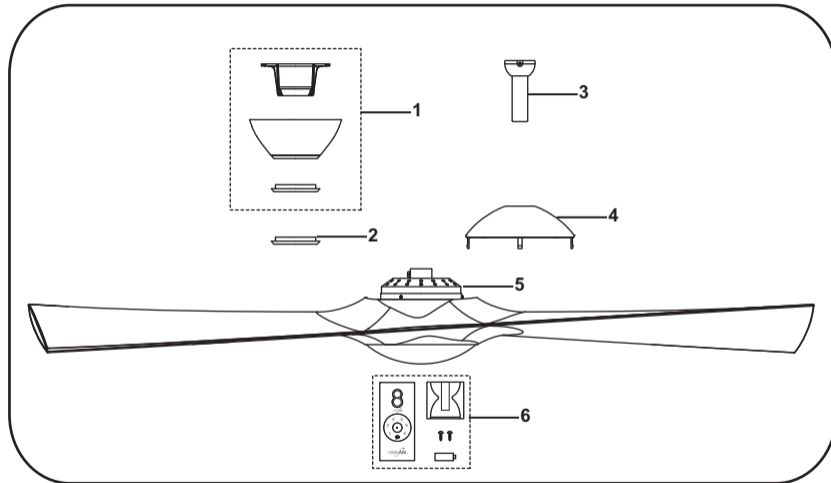



Tools Required: Phillips screw driver; slotted screw driver; step-ladder; wire cutters; electrical tape.

## INSTALLING THE FAN

### MOUNTING OPTIONS

If there isn't an existing mounting box, then read the following instructions. Disconnect the power by removing fuses or turning off circuit breakers.

Secure the outlet box directly to the building structure. Use appropriate fasteners and building materials. The outlet box and its support must be able to fully support the moving weight of the fan (at least 50 lbs.). Use a UL Listed metal outlet box. Do not use a plastic outlet box.

Figure 1, 2 and 3 are examples of different ways to mount the outlet box.

Note: You may need a longer downrod to maintain proper blade clearance when installing on a steep, sloped ceiling. Longer downrods are available from your Minka-Aire® dealer.

To hang your fan where there is an existing fixture but no ceiling joist, you may need to install a hanger bar as shown in Fig. 4 (available at your Minka-Aire® dealer).

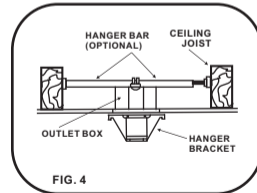
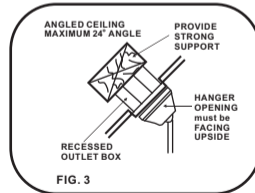
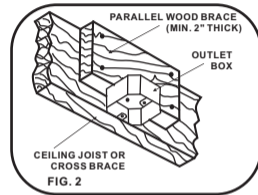
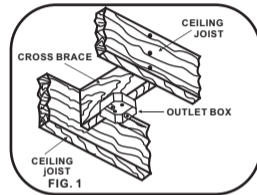

# 4

## ***HANGING THE FAN***

**WARNING:** All of the parts, hardware and components such as the hanger bracket and hanger ball have been provided for your safety and the proper installation of your new ceiling fan. The use of other parts, hardware or components not supplied by Minka Aire® with the fan will void the Minka Aire® Warranty.

**REMEMBER** to turn off the power. Follow the steps below to hang your fan properly:

**Step 1.** Remove the decorative canopy bottom cover from the canopy by turning the cover counter clockwise. (Fig. 5)

**Step 2.** Remove the hanger bracket from the canopy by removing the non-slotted screw from the bottom of the hanger bracket and loosening the slotted one a half turn from the screw head. Next, turn the canopy counter clockwise to removing the hanger bracket from the canopy. (Fig. 5)

**Step 3.** Secure the hanger bracket to the ceiling outlet box using screws included with your outlet box, lock washers included with the fan. (Fig.6)

**Step 4.** Loosen the two set screws and remove the hitch pin and lock pin from the top coupling of the motor assembly. (Fig. 7)

**Step 5.** Remove hanger ball from downrod assembly by loosening set screw, removing the cross pin, and sliding ball off rod. (Fig. 8)

**Step 6.** Carefully feed fan wires up through the downrod. (Fig. 9) Thread the rod into the coupling, next line up holes and replace lock pin and hitch pin. Tighten set screws.

Step 7. Slip Top Housing, Canopy cover and Canopy onto Downrod. Carefully re-install the Hanger Ball onto the Downrod being sure that it's properly positioned over the Cross Pin and the wires are not twisted, tighten Set Screw. (Fig. 10)

Make sure the arrow inside the top housing aligns with the arrow on the motor before installing the top housing onto the blade. (Fig. 11)

Step 8. Lift the Motor Assembly and place the Hanger Ball into the Hanger Bracket. Rotate the Motor Assembly as needed until the check groove from the Hanger Ball rests firmly over the registration tab from the Hanger Bracket. Motor Assembly should not rotate if this is done correctly. (Fig. 12)

**Note:** The canopy cover with the larger opening is for a slope ceiling installation.

**Noted:** If the top housing installation is improper, use a straight slot screwdriver to remove the top housing.

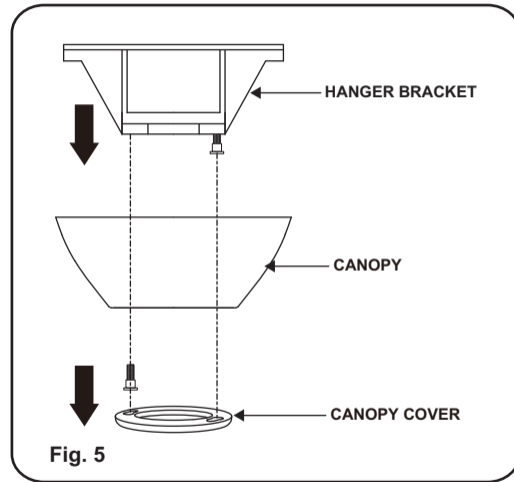

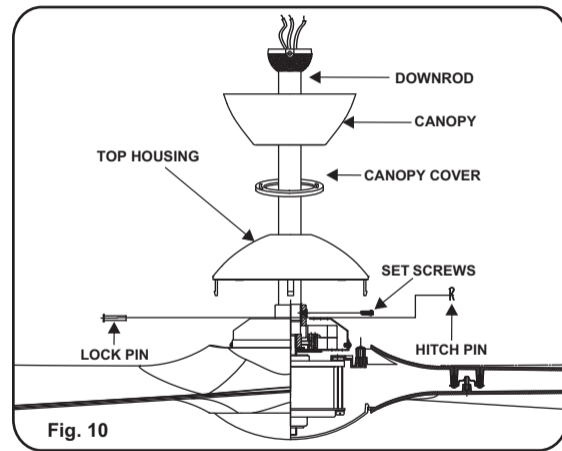
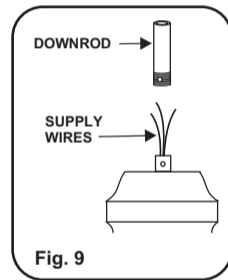
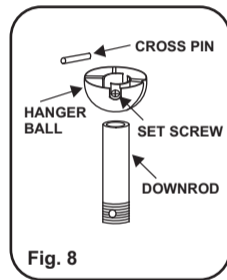
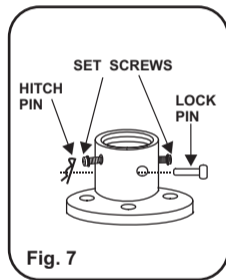
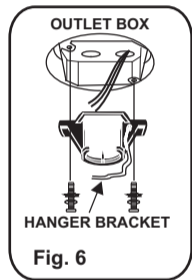

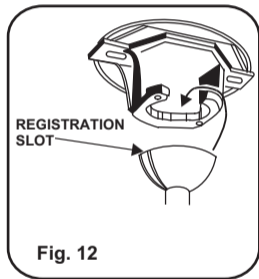
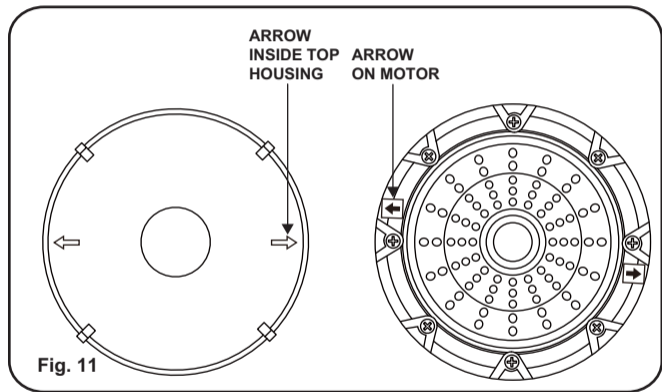

## 5

## ELECTRICAL CONNECTIONS

**WARNING:** To avoid possible electrical shock be sure electricity is turned off at the main fuse or breaker box before wiring.

**NOTE:** The Aire Control® System for this DC motor fans is equipped with a learning frequency function which has 32 code combinations to prevent potential interference from other remote units. The frequency on your Receiver and Transmitter units have been preset at the factory. (Fig. 13) No frequency change is necessary, should you desire to install another Minka Aire DC motor fan within the same home or area with a separate frequency code please see the "frequency interference" troubleshooting section of this instruction manual to learn how to change the frequency.

**Step 1. Motor to House Supply Wires Electrical Connections:** Connect the **WHITE** wire (Neutral) from the outlet box to the **WHITE** wire marked "AC in N" from the motor. Connect the **BLACK** wire (Hot) from the outlet box to the **BLACK** wire marked "AC in L" from the motor. Secure all wire connections with the plastic wire nuts provided. (Fig. 14)

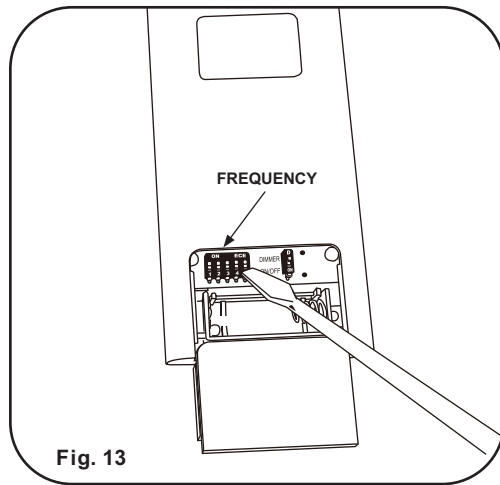
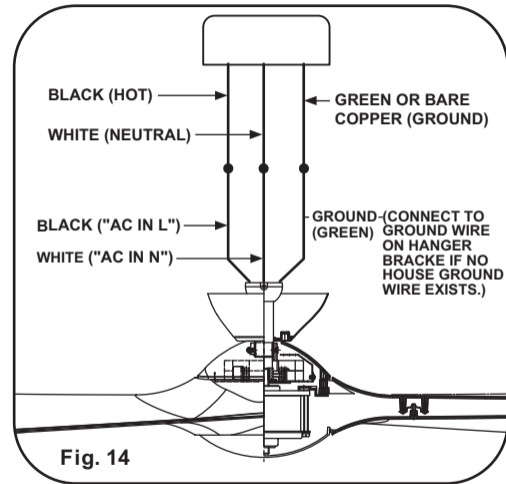

Fig. 13

Step 2. If your outlet box has a GROUND wire (Green or Bare Copper) connect this wire to the Hanger Ball and Hanger Bracket Ground wires. If your outlet box does not have a Ground Wire, then connect the Hanger Ball and Hanger Bracket Ground Wires together. Secure wire connection with the plastic wire nut provided. (Fig. 14)

After all splices are made, check to make sure there are no loose strands. As an additional precaution we suggest to secure the plastic wire connectors to the wires with electrical tape.



## 6

## FINISHING THE INSTALLATION

Step 1. Slide the canopy up towards the hanger bracket and place the key hole on the canopy over the screw on the hanger bracket, turn canopy until it locks in place at the narrow section of the key holes. (Fig. 15)

Step 2. Align the circular hole on canopy with the remaining hole on the hanger bracket, secure by tightening the two set screws.

**Note:** Adjust the canopy screws as necessary until the canopy and canopy cover are snug.

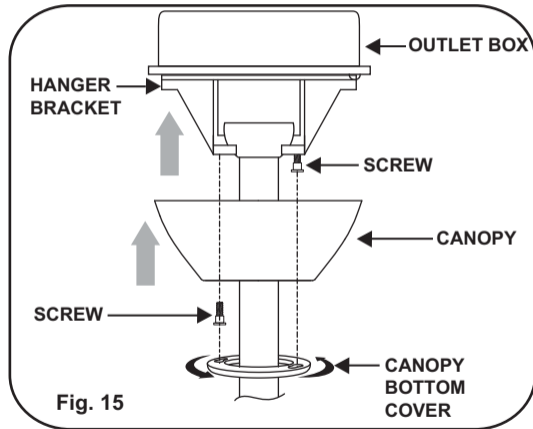



## OPERATING THE REMOTE CONTROL/WALL CONTROL

Remote Control only: Install a A23 12 volt battery (included). To prevent damage to transmitter remove the battery if not used for long periods of time.

**IMPORTANT: THIS REMOTE CONTROL & DC FAN MOTOR ARE DESIGNED TO PERFORM A ONE TIME SELF CALIBRATION TEST. THIS TEST WILL BEGIN ONCE A NEW CODE HAS BEEN SET, AND WILL LAST APPROXIMATELY SIX MINUTES.**

Your DC brushless motor is equipped with a self learning frequency function remote control. Restore power to ceiling fan and test the transmitter as below for proper operation:

A. 1, 2, 3, 4, 5 and 6 button:

These six buttons are used to set the fan speed as follows:

1 = minimum speed

2 = low speed

3 = medium low speed

4 = medium speed

5 = medium high speed

6 = high speed

B.  Reverse button:

This button is used to change the direction of the rotation of the blades; forward for warm weather or reverse for warm weather.

C.  button:

This button turns the power Off and On to the Fan and Light(s).

D.  Button:

These buttons turn the light ON or OFF and also control the brightness settings of the light. The following instructions apply to ceiling fans that feature a DOWN light

( button) only or ceiling fans that feature an UP light ( button) and a DOWN light ( button) that are controlled independent of each other;

Press and release the button for the desired light to turn the light ON or OFF. Press and hold the button to set the desired light brightness. The light will cycle between bright and dim settings as long as the button is pressed. The light key has an automatic auto-resume feature that allows the light to remain at the same brightness as the last time it was turned off.

**NOTE: THIS FAN HAS BEEN PRECISION BALANCED AT THE FACTORY AND WILL NOT NEED TO BE BALANCED AGAIN.**

Note: The auto learning function will only mandate within 60 seconds when turning the fan's AC power ON.

1. Select desired frequency from the back of transmitter.

2. Press the transmitter's "Off" button, and hold the "Off" button for over 5 seconds. Once the receiver has detected the frequency, the fan will automatically begin to operate and start to rotate in the counter-clockwise direction and on the highest RPM for 3 minutes. When counter-clockwise rotation has finished, the fan will automatically reverse to clockwise direction again to the highest RPM for 3 minutes. Fan will

shut off when the self calibration test has finished. The total self calibration test will last about 6 minutes.

Note: During self calibration test, the remote will be non-function.

Note: The learning frequency function and self calibration test will continue to retain the last set frequency and calibration set even when the AC power is shut off. If the frequency is changed the self calibration test will occur again.

1. Lock position: The DC motor has a built-in safety against obstruction during operation. The motor will get locked operation and disconnect

power after 30 seconds if interruption occurs. Please remove obstacles before re-set.

2. Over 38W protection: When the receiver detects motor power consumption which is greater than 38W, the receiver's power will stop and operation will be immediately discontinued. Turn the receiver power on after 5 seconds.

3. "D" and "ON" dip switch:  
The "D" selection is the light dimmable selection and is to be used with all bulbs except for CFL bulbs. The "ON" selection is For CFL bulbs.

Speed settings for warm or cold weather depend on factors such as room size, ceiling height and number of fans.

**NOTE:** To change the direction of the rotation of the blades the fan must be in operation mode.

**Warm Weather (forward)**

A **DOWNWARD** airflow creates a cooling effect as shown in Figure 16. This allows you to set your air conditioner on a warmer setting without affecting your comfort.

**Cool Weather (Reverse)**

An **UPWARD** airflow moves warmer air off the ceiling area as shown in Figure 17. This allows you to set your heating unit on a cooler setting without affecting your comfort.

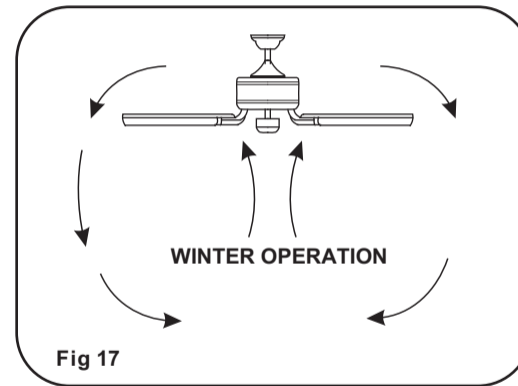
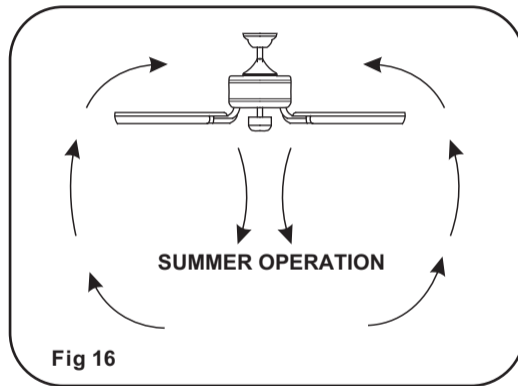

# 8

## CARE OF YOUR FAN

Here are some suggestions to help maintain your fan.

**ATTENTION:** Use the white cotton gloves provided when handling the wing. Natural oils on fingers can leave permanent marks on the finish.

1. Because of the fan's natural movement some connections may become loose. Check the support connections, brackets and blade attachments twice a year. Make sure they are secure. (It is not necessary to remove fan from the ceiling).

2. Clean your fan periodically to help maintain its new appearance over the years. Use only a soft brush or lint free cloth to avoid scratching the finish. Plated finishes are sealed with lacquer to minimize discoloration or tarnishing. Do not use water when cleaning, this could damage the motor, wood blades or possibly cause an electrical shock.

3. If your fan is provided with wood veneer blades; you can apply a light coat of furniture polish for additional protection and enhanced beauty.

Cover small scratches with a light application of shoe polish.

4. Use a lint free lightly damp cloth (one included with your fan) with lukewarm water or duster to remove dust from the blades.

5. There is no need to oil your fan. The motor has permanently lubricated bearings.

6. If your fan is provided with glass shades, clean with lukewarm soapy water and a soft cloth or sponge. **DO NOT IMMERSE GLASS SHADES IN HOT WATER. DO NOT PUT GLASS SHADES INTO AN AUTOMATIC DISHWASHER.**

### WARNING!

**MAKE SURE THE POWER IS OFF AT THE ELECTRICAL PANEL BOX BEFORE YOU ATTEMPT ANY REPAIRS. REFER TO THE SECTION, "ELECTRICAL CONNECTIONS".**

## TROUBLESHOOTING

### SYMPTOM

Fan will not start

### SOLUTION

- Check to make sure the wall switch is turned on.
- Check circuit fuses or breakers.
- **Caution!** Make sure the power is turned off before performing the following steps. Remove canopy and check wire connections.
- If using a remote controlled fan; check to see that the dip switches from transmitter and receiver are set to the same frequency code.
- Check wall control transmitter connections (if applicable).
- **Note:** Fan must be installed from a maximum distance of 23 feet from the transmitting unit for proper signal transmission between the transmitting unit and the fan's receiving unit.

### SYMPTOM

Fans/Light Turn On and Off Unexpectedly

### SOLUTION

- This is caused by interference, change the code frequency from the transmitter and receiver. Any code combination will operate the fan or light (remote controlled fans only). (if applicable)

### SYMPTOM

Fan Sounds Noisy

### SOLUTION

- Allow a 24-hour "break in" period. Most noises associated with a new fan will go away during this time.
- Make sure outlet box is secured to building structure, if necessary use the wood screws provided to further secure outlet box to joist.
- Make sure hanger bracket is secure to the outlet box, screws are tight.

### SYMPTOM

Fan Wobble

### SOLUTION

- Make sure outlet box is secured to building structure, if necessary use the wood screws provided to further secure outlet box to joist.
- Make sure hanger bracket is secure to the outlet box, screws are tight.

## SYMPTOM

Frequency Interference

## SOLUTION

1. Turn the power off to your ceiling fan.
2. Please use a small size tool to change the frequency settings on the control system.
3. Return power to the unit.  
Note: After the AC power is on, do not press any other button on the transmitter before pressing the "OFF" button, doing so will cause the procedure to fail.
4. Within 60 seconds of turning the Fan's AC power ON. Press the transmitter's "OFF" button and hold the "OFF" button for 5 seconds.
5. Once the receiver has detected the set frequency, the fan will begin a 6 minutes self calibration test.
6. The receiver has now learn the frequency which has been selected on the transmitter. After completing the steps above, you should be able to operate the ceiling fan and light. If the fan is not responding to the transmitter, please turn the power off to the receiver, and repeat the process.

## SPECIFICATIONS

10

These are typical readings. Your actual fan may vary. They do not include amps and wattage used by the light(s).

Fan Size	Speed	Volts	Amps	Watts	RPM	CFM	N.W.	G.W.	C.F.
52"	Low	120	0.06	3.6	51	1948			
	Medium Low	120	0.09	5.5	71	2864			
	Medium	120	0.14	9.0	91	3686	6.13	8.4	4.286'
	Medium High	120	0.20	13.5	111	4519	kgs	kgs	
	High	120	0.30	19.9	130	5370			
Extra High	120	0.44	30.4	155	5974				

*For any additional information about your Minka Aire® Ceiling fan, please write to:*



1151 W. Bradford Court, Corona, CA 92882 • For Customer Assistance Call: 1-800-307-3267



# PERFORMANCE AND ENERGY INFORMATION

*For any additional information about your  
Minka Aire® Ceiling fan, please write to:*



1151 W. Bradford Court, Corona, CA 92882

• For Customer Assistance Call: 1-800-307-3267

FAN SPEED	AIRFLOW (CFM)*	POWER USE (watts)	AIRFLOW EFFICIENCY (CFM/watt)
Low	1948	3.6	464
2nd	2864	5.5	441
3rd	3686	9.0	392
Medium	4519	13.5	310
5th	5370	19.9	247
High	5974	30.4	198

**Ceiling fan airflow is measured in cubic feet per minute (CFM).  
Power use is measured in watts. To maximize energy savings:**

- Choose a fan with high airflow efficiency (CFM/watt).
- Use ENERGY STAR®-labeled lighting in your fan.
- Remember to switch off your fan when you leave the room.

\* Measured according to the ENERGY STAR® approved Solid State test method