

FAUCET DESCRIPTION

- Chrome plated brass construction
- Supplied with 9" spout
- 1/2" IPS connections
- Supplied with vandal resistant screws

OPERATION

- Lever style handle with hot and cold color indicators
- Temperature controlled by 180° arc of handle travel

FLOW

- 2.2 MAX. gpm (8.3 L/min) aerator

CARTRIDGE

- 1225 cartridge design
- Nonmetallic/nonferrous and stainless steel material

STANDARDS

- Third party certified by CSA to meet CSA B-125 and ASME A112.18.1M and all applicable specifications referenced therein and complies with the requirements of ANSI A117.1, NSF 61/9, and California Proposition 65.

WARRANTY

- Warranted for 5 years against material or manufacturing defects

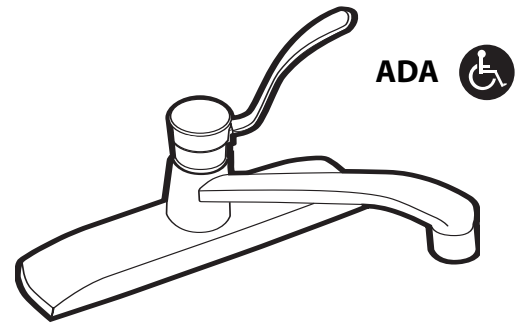

Single-Handle Kitchen Faucet

Model: 8710

NOTE: DESIGNED TO INSTALL THROUGH 3 HOLES 1" MIN. DIA. AND 4" ON CENTER

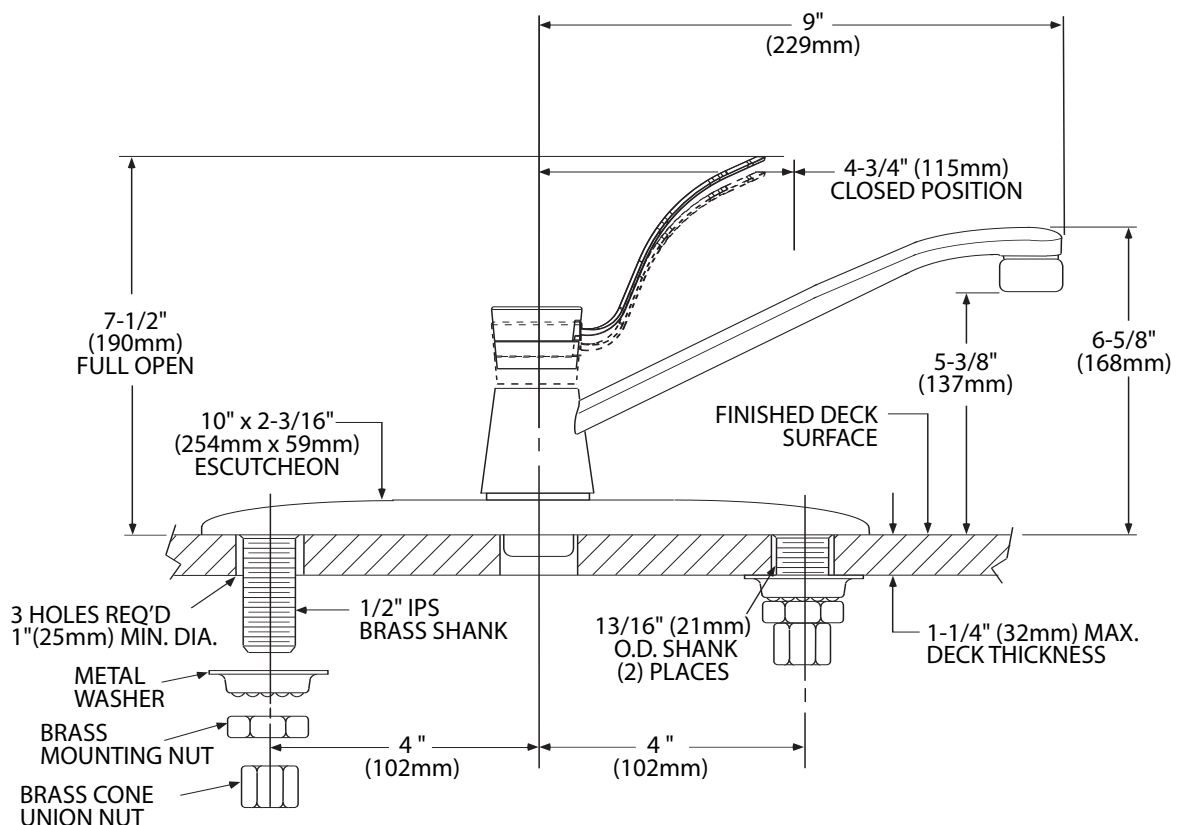

CRITICAL DIMENSIONS

(DO NOT SCALE)