

**Prep Sink / Bar Faucet
1628**

Features

- Solid brass construction
- Forged brass body with integral spout and handles
- Quarter-turn washerless ceramic disc valve cartridges
- ADA compliant handles
- 10" (25.4 cm) spout height at outlet
- 5-1/4" (13.3 cm) spout reach (c-c)
- 1.5 gallons (5.7 liters) per minute maximum flow rate



Colors / Finishes

- 10B: Oil Rubbed Bronze
- 15: Polished Nickel
- 15S: Satin Nickel
- 26: Polished Chrome
- Other: Refer to the Newport Brass catalog for additional color/finish options.

Codes / Standards Compliance

Meets or exceeds the following at date of manufacture:

- ASME A112.18.1/CSA B125.1
- IAPMO/UPC
- IPC
- NSF 61
- ADA
- ICC/ANSI A117.1
- Energy Policy Act of 1992
- All applicable US Federal and State material regulations
- EPA WaterSense®

Specified Model

Model	Description	Colors / Finishes
1628	Prep Sink / Bar Faucet	<input type="checkbox"/> 10B <input type="checkbox"/> 15 <input type="checkbox"/> 15S <input type="checkbox"/> 26 <input type="checkbox"/> Other

Product Specification:

Add "Color / Finish" suffix to Model number, below.

The Prep Sink / Bar Faucet shall be made of solid brass construction. Faucet shall feature a forged brass body. Faucets shall feature quarter-turn washerless ceramic disc valve cartridges. Prep Sink / Bar Faucet shall have a 1.5 gallon (5.7 L) per minute maximum flow rate. Product have a 10" (25.4 cm) spout height at outlet, 5-1/4" (13.3 cm) spout reach (c-c) and incorporate ADA compliant handles. Prep Sink / Bar Faucet shall be Newport Brass Model 1628/_____.

NEWPORT KITCHEN

Product Dimensions (units are in inches)

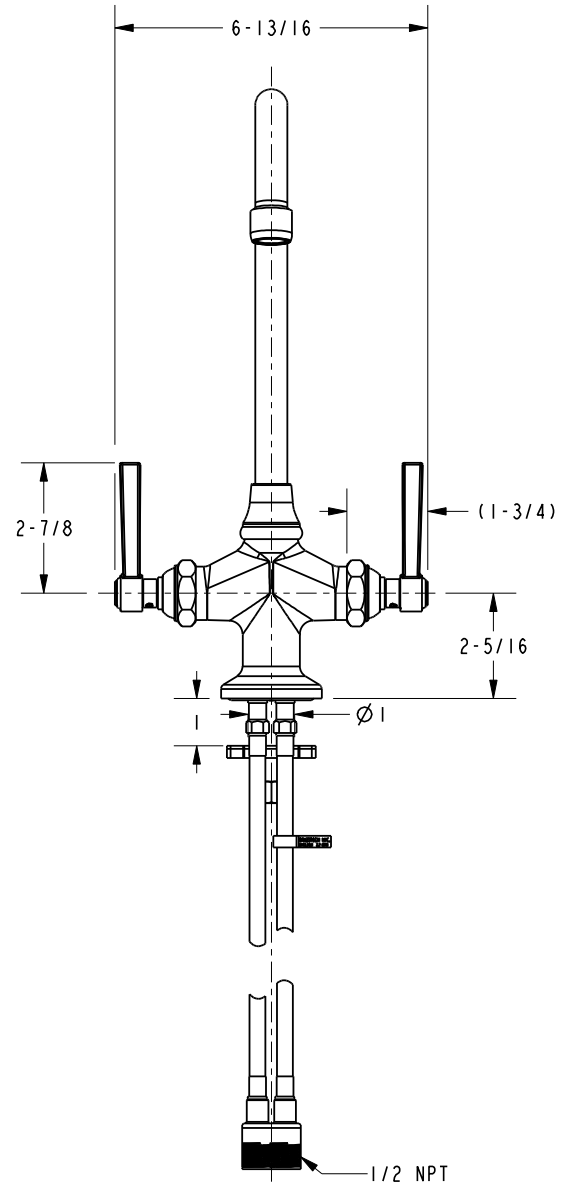
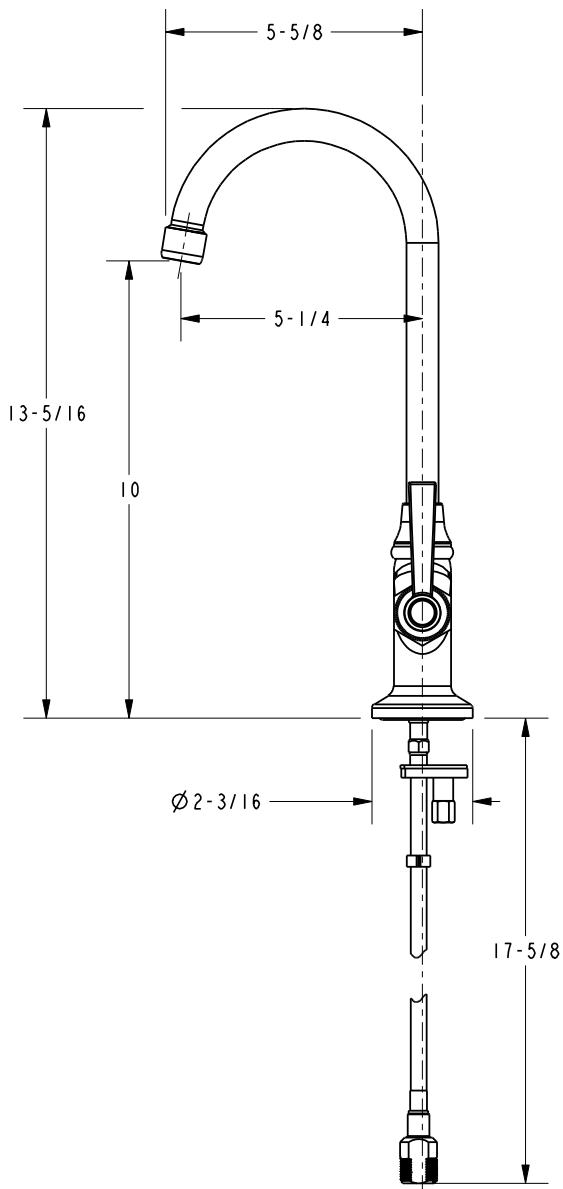

Miro Prep Sink / Bar Faucet
1628

NEWPORT BRASS
Flawless Beauty. From Faucet to Finish.™