

18" x 3/4" Towel Bar (square bar)

Model: BC2-13818

Features

- Material: Zinc Die-cast
- Concealed Surface Mount Application
- Provided with
 - Mounting Plate: 1-3/4" x 1-1/8"
 - Plastic Anchors x 4
 - Steel Phillips Head Screws #8 x 1-1/4"
- Projection: 3-1/4" from the Mounting Surface
- Overall Size: 20-3/4" x 1-7/8"

*Campbell
Collection*

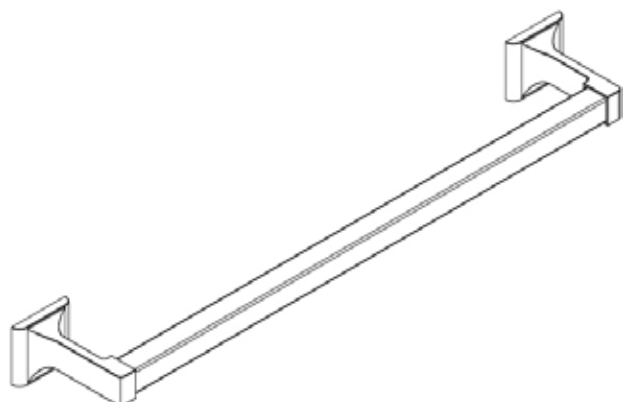

Available Finish:

- Chrome
- Polished Brass

