

## Regal® Model Flushometer

116  
116-1.6

### ► Description

Exposed Water Closet Flushometer, for floor mounted or wall hung top spud bowls.

### ► Flush Cycle

- Model 116 Water Saver (3.5 gpf/13.2 Lpf)
- Model 116-1.6 Low Consumption (1.6 gpf/6.0 Lpf)

### ► Specifications

Quiet, Exposed, Diaphragm Type, Chrome Plated Closet Flushometer with the following features:

- ADA Compliant Metal Oscillating Non-Hold-Open Handle
- 1" I.P.S. Screwdriver Bak-Chek™ Angle Stop
- Vandal Resistant Stop Cap
- Adjustable Tailpiece
- Vacuum Breaker Flush Connection
- Spud Coupling, Wall and Spud Flanges for 1½" Top Spud
- High Copper, Low Zinc Brass Castings for Dezincification Resistance
- Non-Hold-Open Handle and No External Volume Adjustment to Ensure Water Conservation
- Low Consumption flush accuracy controlled by Para-Flo™ Technology
- Handle Packing, Stop Seat and Vacuum Breaker to be Molded from PERMEX™ Rubber Compound for Chloramine Resistance

Valve Body, Cover, Tailpiece and Control Stop shall be in conformance with ASTM Alloy Classification for Semi-Red Brass. Valve shall be in compliance to the applicable sections of ASSE 1037, ANSI/ASME 112.19.6, and Military Specification V-29193.

### ► Variations

- TP** Trap Primer
- YB** Sweat Solder Adapter Kit with Stamped Flange
- YBYC** Sweat Solder Adapter & Cast Wall Flange w/Set Screw
- YI** Two Wall Bumpers (for open front seat without cover)
- YJ** Split Ring Pipe Support
- YK** Solid Ring Pipe Support

### **XL** Regal XL

Flushometer includes ADA Compliant Handle, Vandal Resistant Stop Cap with Set Screw, and Sweat Solder Adapter with Cover Tube and Cast Set Screw Wall Flange.

See Accessories Section of the Sloan catalog for details on these and other Flushometer variations.

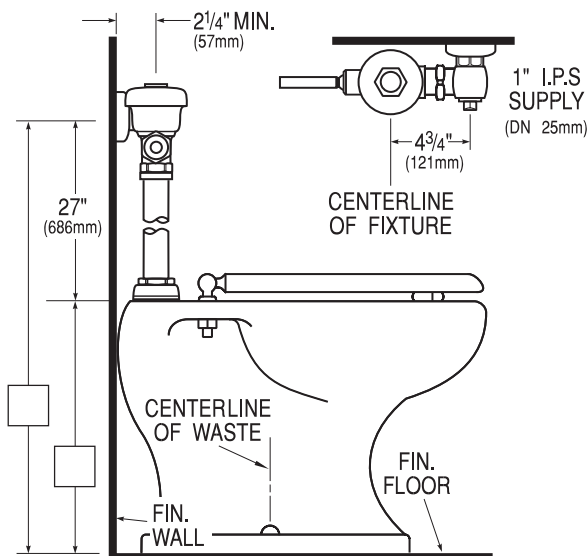

This space for Architect/Engineer approval

The information contained in this document is subject to change without notice.

**SLOAN**

Made in the U.S.A.

SLOAN VALVE COMPANY • 10500 SEYMOUR AVE. • FRANKLIN PARK, IL. 60131  
Ph: 1-800-9-VALVE-9 or 1-847-671-4300 • Fax: 1-800-447-8329 or 1-847-671-4380

<http://www.sloanvalve.com>