

Systems for Wall-Hung Toilets, 2x6 Installations

Replacement Parts for Geberit Duofix Carriers 111.335.00.5 and 111.335.00.6

Item No.	Model No.	Description	List Price
1	242.314.00.1	Materials for concealed carrier and tank installation	\$39.00
2	242.315.00.1	Splash guard protection cover for UP320	6.00
3	241.826.00.1	Mud guard protection housing for Sigma concealed tanks 2x6 (UP320) and 2x4 (UP720), Plastic	11.00
4	362.771.00.1	Seal for concealed flush pipe, EPDM	2.00
5	362.796.92.1	Protection plug, Plastic	5.00
6	240.189.00.1	Threaded rod for wall-mounted toilet or bidet installation	4.00
7	152.404.46.1	Connector set with mounting hardware (bowl installation kit), HDPE; Matte Chrome cover caps	38.00
7.1	217.713.46.1	Cover caps with leveling washer, Plastic, Matte Chrome	6.00
7.2	119.668.00.1	Seal for supply inlet tube, EPDM	2.00
7.3	152.424.00.1	Seal for toilet outlet connector, EPDM	3.00
8	366.061.16.1	HDPE waste fitting outlet bend, 1 x 90° bend with socket for Ø3.50" (Ø90 mm) push fit piping and Ø3.50" (Ø90 mm) outlet	19.00
8.1	387.282.00.1	Seal for outlet bends, EPDM	5.00
9	366.820.92.1	Protection plug, Plastic	4.00



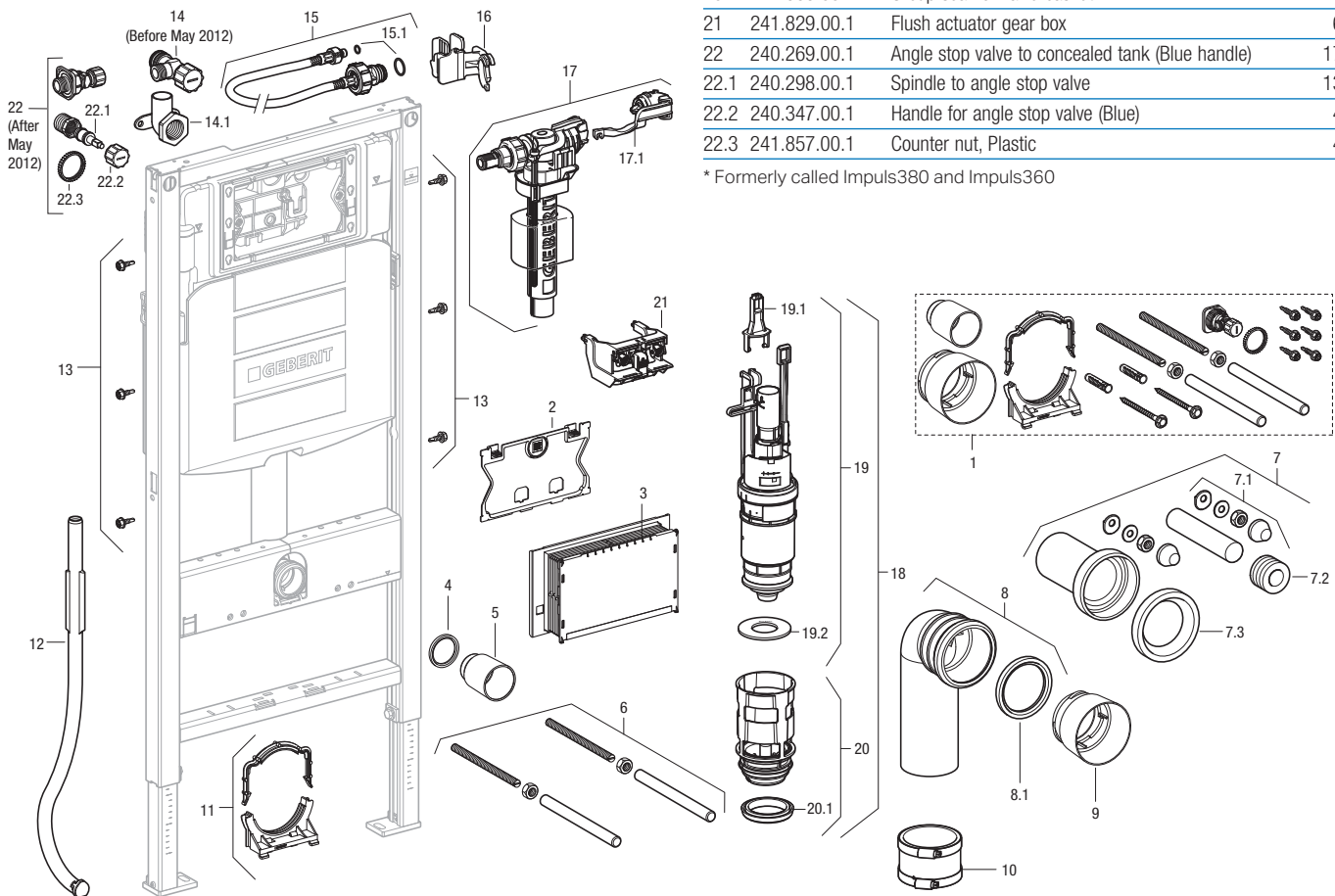

Item No.	Model No.	Description	List Price
10	240.782.00.1	Flexible Coupling for pipes	\$62.00
11	242.012.00.1	Outlet pipe bracket (complete)	4.00
12	242.010.00.1	Conduit pipe for shower toilet water supply with Sigma concealed tank (UP300 and UP320)	5.00
13	111.892.00.1	Frame mounting screws for steel stud construction, Galvanized; self-tapping	3.00
14	240.853.00.1	Supply angle Stop (black handle)	14.00
14.1	240.851.00.1	Drop Ear Elbow, Copper	11.00
15	240.921.00.1	Connection hose for Sigma concealed tank, 3/8"	14.00
15.1	240.922.00.1	Seal kit for braided hose, EPDM O-Ring	9.00
16	240.923.00.1	Fixation clip for filling valve	6.00
17	241.469.00.1	Filling valve Type 380* for Sigma and Kappa concealed tanks	24.00
17.1	240.771.00.1	Seal kit for filling valve Type 380*	11.00
18	241.858.00.1	Dual-flush valve complete with valve seat basket	12.00
19	240.622.00.1	Dual-flush valve for Sigma concealed tank	12.00
19.1	241.167.00.1	Yoke set for flush valves	9.00
19.2	816.418.00.1	Flat gasket for flush valve	2.00
20	241.859.00.1	Valve seat basket and noise bushing for flush valve	9.00
20.1	241.868.00.1	U-cup seal for valve basket	2.00
21	241.829.00.1	Flush actuator gear box	6.00
22	240.269.00.1	Angle stop valve to concealed tank (Blue handle)	17.00
22.1	240.298.00.1	Spindle to angle stop valve	13.00
22.2	240.347.00.1	Handle for angle stop valve (Blue)	4.00
22.3	241.857.00.1	Counter nut, Plastic	4.00

* Formerly called Impuls380 and Impuls360



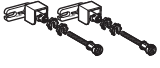
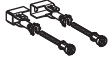

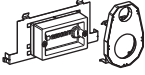
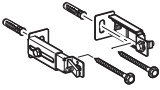

Optional Accessories for Geberit Duofix Carriers 111.335.00.5 and 111.335.00.6



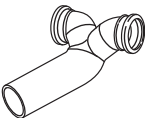
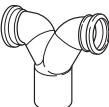

Mounting Accessories for Carrier Frames

Description	Model No.	List Price
 Frame to wall anchoring for 5.125"-7.875" (13-20 cm) thick unfinished pre-wall	111.815.00.1	\$30.00
 Frame to wall anchoring for 5.125"-7.875" (13-20 cm) thick unfinished pre-wall corner installations	111.835.00.1	30.00
 Support brackets for wall-hung toilets with small contact surface (thin profiles)	111.847.00.1	40.00
 Fire protection set for Sigma concealed dual-flush tanks; 90 min. fire resistance to DIN EN 1364-1:1999-10	111.863.00.1	464.00
 Frame to wall anchoring where foot installations into floor are not allowed for 5.125"-7.875" (13-20 cm) thick unfinished pre-wall	111.867.00.1	61.00
 Frame to stud fastening set for extended stud spacing from 19.75"-25.56" (50-65 cm)	111.869.00.1	30.00
 Frame to wall anchoring extensions for 7.875"-15.75" (20-40 cm) thick unfinished pre-wall	111.887.00.1	11.00



Waste Fittings

 HDPE straight connector with socket for Ø3.50" (Ø90 mm) push fit piping and Ø3.50" (Ø90 mm) outlet x 12" (31 cm) long	366.887.16.1	30.00
 HDPE connector with offset for LH horizontal drain connections (as viewed from sitting position), 1 x 90° bend with socket for Ø3.50" (Ø90 mm) push fit piping, with 45° offset and Ø3.50" (Ø90 mm) outlet for 5.5" (13.97 cm) minimum walls only	366.913.16.1	67.00
 HDPE connector with offset for RH horizontal drain connections (as viewed from sitting position), 1 x 90° bend with socket for Ø3.50" (Ø90 mm) push fit piping, with 45° offset and Ø3.50" (Ø90 mm) outlet for 5.5" (13.97 cm) minimum walls only	366.914.16.1	67.00
 Cast iron outlet bend; 1 x 90° bend with socket for Ø3.50" (Ø90 mm) push fit piping and 3" CIP outlet	367.071.18.1	138.00
 HDPE "Back-to-back" connector for horizontal drain connections; 2 x 90° bends with sockets for Ø3.50" (Ø90 mm) push fit piping, with 45° offset and expansion to Ø4.375" (Ø110 mm) outlet for 10.75" (27.31 cm) minimum walls only.	367.485.16.1	138.00
 HDPE "Back-to-back" connector for vertical drain connections; 2 x 90° bends with sockets for Ø3.50" (Ø90 mm) push fit piping and expansion to Ø4.375" (Ø110 mm) outlet for 10.75" (27.31 cm) minimum walls only.	367.923.16.1	138.00

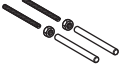

Bowl Connection Sets and Accessories

Description	Model No.	List Price
 HDPE connection set with 1" (2.5 cm) offset and mounting hardware (bowl installation kit); with socket for Ø3.50" (Ø90 mm) push fit piping and Ø55 supply inlet; Matte Chrome cover caps	405.116.00.1	\$205.00
 Acoustic insulation set for wall-hung toilets and bidets	156.050.00.1	15.00
 Connector set with mounting hardware (bowl installation kit), HDPE; Alpine White cover caps	152.404.11.1	38.00
 Cover caps with leveling washer, Plastic, Alpine White	217.713.11.1	6.00

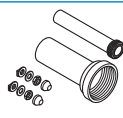
Required Accessories for 3.50"-7.00" (9-18 cm) Finished Wall Thickness

 Mounting rod extension set for wall-hung toilet and bidet, M12	242.232.00.1	60.00
 Mud guard protection housing for Sigma concealed tanks 2x6 (UP320) and 2x4 (UP720), Plastic	241.826.00.1	11.00
 Extension set for actuator plates for Sigma concealed tanks 2x6 (UP300, UP320) and 2x4 (UP720) and Kappa concealed tank (UP200)	240.938.00.1	19.00
 HDPE Connector set for extended installation and mounting hardware (bowl installation kit), with socket for Ø3.50" (Ø90 mm) push fit piping and Ø55 supply inlet; Matte Chrome cover caps	152.438.46.1	50.00

Actuator Accessories for Push Buttons

 Cover plate for Sigma concealed tanks 2x6 (UP300, UP320) and 2x4 (UP720), Zinc die cast, Alpine White	115.765.11.1	221.00
 Cover plate for Sigma concealed tanks 2x6 (UP300, UP320) and 2x4 (UP720), Zinc die cast, Matte Chrome	115.765.46.1	221.00
 Cover plate for Sigma concealed tanks 2x6 (UP300, UP320) and 2x4 (UP720), Stainless Steel, Brushed SS	115.798.00.1	175.00

Actuator Accessories for AC Hands Free Device

 NEW Transformer for Mambo AC powered hands free actuator.	115.861.00.1	100.00
--	--------------	--------

Bidet Seat Accessory for Carrier Frames

 Water supply hose for bidet seat 111.355.00.5, 111.728.00.1 and 111.255.00.1 carriers with Sigma concealed tanks 2x6 and 2x4 (UP320, UP720) and Kappa concealed tank (UP200). For adding bidet seat to an installed carrier.	249.801.00.1	135.00
--	--------------	--------