

# Installation Instructions / Warranty

## FIX FIT STOP

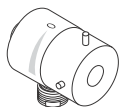

**Starck**  
10882XX1

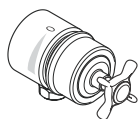

**Montreux**  
16882XX1

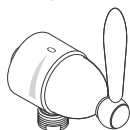

**Carlton**  
17882XX1

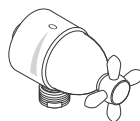

**Carlton**  
17883XX1

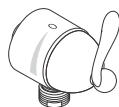

**Phoenix**  
17982XX1

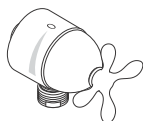

**Phoenix**  
17983XX1

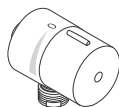

**Steel**  
35882801

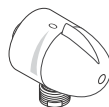

**Allegroh**  
36882XX1

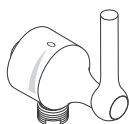

**Terrano**  
37882XX1

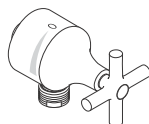

**Terrano**  
37883XX1

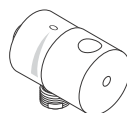

**Uno**  
38882XX1

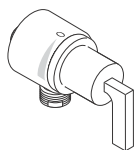

**Citterio**  
39882XX1

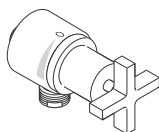

**Citterio**  
39883XX1

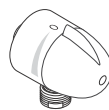

**Mondial/Metris/  
Elegance/Sportive**  
27452XX1

**hangrohe**

AXOR | PHARO

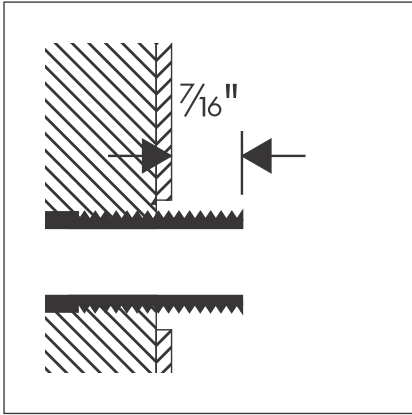

1. This unit requires a 1/2" NPT male nipple, extending 7/16" outside the surface of the finished wall.

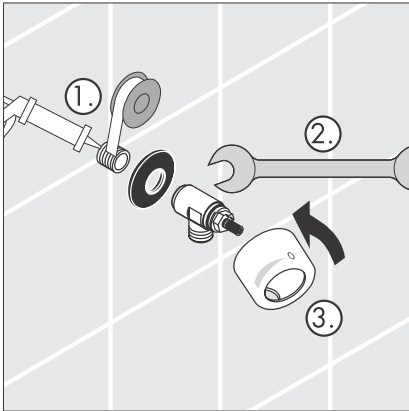

1. Seal the wall around the male pipe fitting using a good quality waterproof bathroom sealant. Wrap thread clockwise with 2 - 3 layers of good quality plumber's thread tape.
2. Position the gasket over the male threaded pipe fitting. Screw the elbow firmly onto the pipe fitting. Test for leaks.
3. Slide the decorative cover over the elbow and snap into place on the gasket.

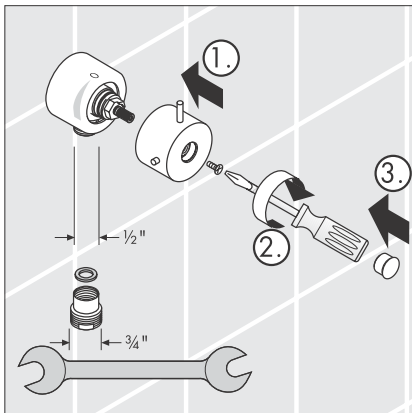

### Handle assembly

10882XX1 Starck  
 37882XX1 / 37883XX1 Terrano  
 16882XX1 Montreux

1. Push the handle onto the shaft.
2. Fix the screw.
3. Cover the hole by the plastic cap.

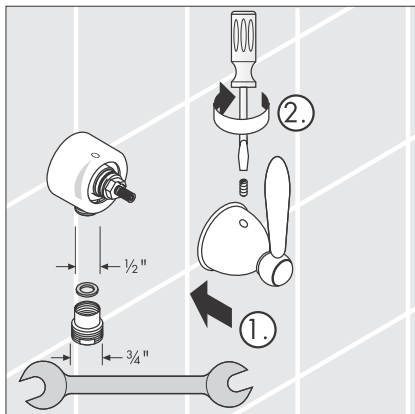

17885XX1 / 17886XX1 Carlton  
17982XX1 / 17983XX1 Phoenix

1. Push the handle onto the shaft.
2. Fix the screw.

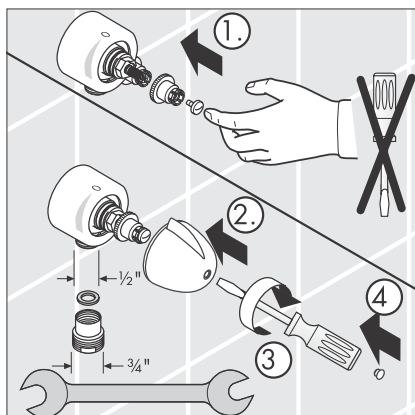

35882801 Steel  
36882XX1 Allegroh  
38882XX1 Uno  
27452XX1 Mondial/Metris/Elegance/Sportive

1. Lock the screw by hand only three turns.
2. Snap on the handle.
3. Fix the screw.
4. Cover the hole by the plastic cap.

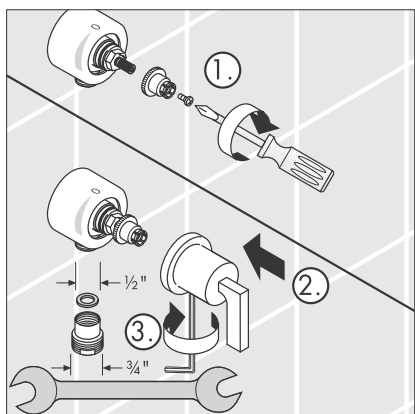

Citerrio 39882XX1 / 39883XX1

1. Install the handle fixation and lock the screw.
2. Snap on the handle.
3. Fix the hollow set screw with a hex wrench 2 mm.

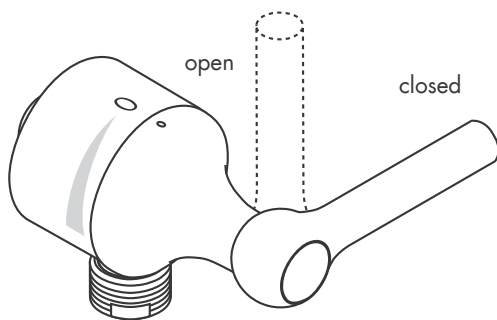

## Spare parts

1	cartridge		96350000
2	sleeve		96240XXX
3	flat seal		98557000
4	non return valve		94074000
5	handle	Starck	10993XX1
5.1	screw-cover	Starck	96540XX1
6	cross handle	Carlton	17993XX1
7	lever handle	Carlton	17298XX1
8	handle	Steel	35993801
8.1	screw-cover	Steel/Allegroh/Uno	
9	handle	Mondial/Metris/Elegance/Sportive Allegroh	96541001
10	cross handle	Mondial/Metris/Elegance/Sportive Terrano	36993XX1
10.1	screw-cover	Terrano	37995XX1
11	lever handle	Terrano	96542XX0
11.1	screw-cover	Terrano	37993XX1
12	handle	Uno	96543XX0
13	lever handle	Uno	38993XX1
14	cross handle	Citterio	39993XX1
15	lever handle	Citterio	39995XX1
16	cross handle	Phoenix	96632XX1
17	cross handle	Phoenix	96792XX1
17.1	screw-cover	Montreux	16593XX0
		Montreux	97987000

XX = Color code:	00 chrome
	09 chrome/gold
	42 platin
	62 oil rubbed bronze
	80 steel
	81 satinox
	82 brushed nickel
	83 polished nickel

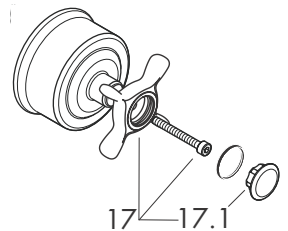
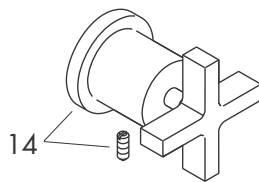
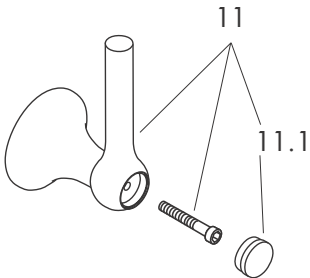
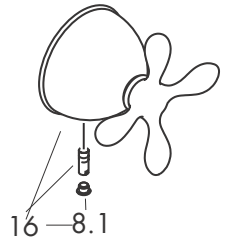
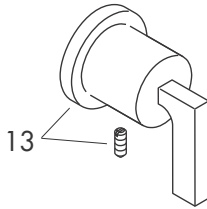
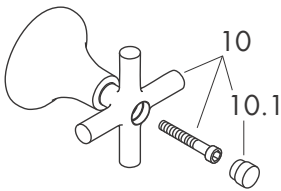
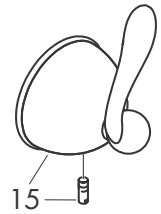
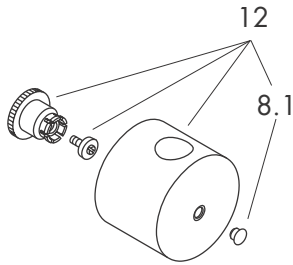
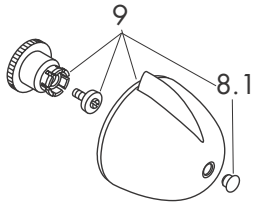
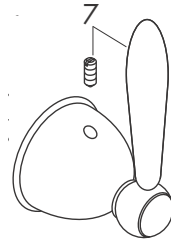
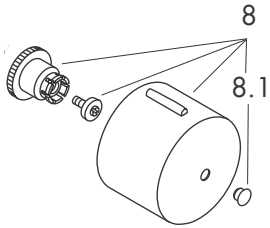
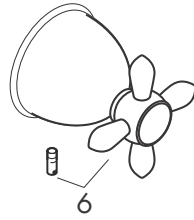
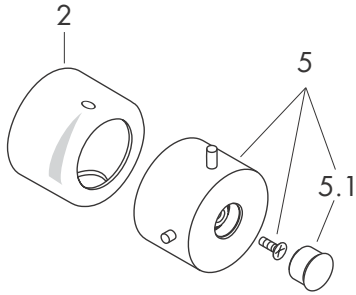
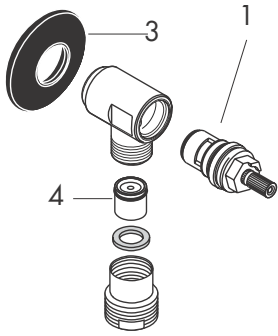

---

## Cleaning Recommendation for Hansgrohe Products

Modern faucetry and shower products utilize a combination of materials to comply with the needs of the market with regard to design and functionality.

To avoid damage, it is necessary to use some caution when cleaning. Damage caused by improper treatment is not covered under the Hansgrohe warranty.

### Cleaning Materials for Faucets and Showers

- To remove lime scale, use only products made specifically for that purpose. Always follow the manufacturer's instructions when using.
- Do not use cleaners that contain hydrochloric, formic, acetic, or phosphoric acids, as these will cause considerable damage to finishes and to plastic components.
- Never mix cleaning materials.
- Never use cleaners containing abrasives. Do not use abrasive cleaning cloths, pads, or sponges.

### Cleaning Procedures

- Clean your faucets and shower products as and when required. Regular cleaning will prevent scale buildup and water spotting.
- Follow the label instructions. Do not allow any cleaner to remain on the product for longer than necessary.
- When using spray cleaners, spray first onto a sponge or cloth – do not spray directly onto the product.
- After cleaning, rinse thoroughly with clear water to remove any cleaner residue.

### Important

- Soap and shampoo residue can also cause damage to the product. Rinse well with clean water after use.
- If the surface is already damaged, harsh cleaning materials will cause further damage.

---

## Limited Lifetime Consumer Warranty

This product has been manufactured and tested to the highest quality standards by Hansgrohe, Inc. („Hansgrohe“). This warranty is limited to Hansgrohe products which are purchased by a consumer in the United States after March 1, 1996, and installed in either the United States or Canada.

### WHO IS COVERED BY THE WARRANTY

This warranty extends to the original consumer purchaser only.

### WHAT IS COVERED BY THE WARRANTY

This warranty covers only your Hansgrohe manufactured product. Hansgrohe warrants this product against defects in material or workmanship as follows: Hansgrohe will repair at no charge for parts only or, at its option, replace any product or part of the product which proves defective because of improper workmanship and/or material, under normal installation, use, service and maintenance. If Hansgrohe is unable to provide a replacement and repair is not practical or cannot be timely made, Hansgrohe may elect to refund the purchase price in exchange for the return of the product.

### LENGTH OF WARRANTY

Replacement or repaired parts of products will be covered for the term of this warranty as stated in the following two sentences. If you are a consumer who purchased the product for use primarily for personal, family, or household purposes, this warranty extends for as long as you own the product and the home in which the product is installed. If you purchased the product for use primarily for any other purpose, including, without limitation, a commercial purpose, this warranty extends only (i) for 1 year, with respect to Interaktiv and Retroaktiv products, and (ii) for 5 years, with respect to AXOR, Shower-Power and Pharo products.

### THIS WARRANTY DOES NOT COVER, AND HANSGROHE WILL NOT PAY FOR:

- A. Conditions, malfunctions or damage not resulting from defects in material or workmanship.
- B. Conditions, malfunctions or damage resulting from (1) improper installation, improper maintenance, misuse, abuse, negligence, accident or alteration, or (2) the use of abrasive or caustic cleaning agents or „no rinse“ cleaning products, or the use of the product in any manner contrary to the product instructions.
- C. Labor or other expenses for the disconnection or return of the product for warranty service, or for installation or reinstallation of the product.
- D. Accessories or related products not manufactured by Hansgrohe.

---

## TO OBTAIN WARRANTY SERVICE

Contact your Hansgrohe retailer, or write to Technical Service at:

Hansgrohe Inc.  
1492 Bluegrass Lakes Parkway  
Alpharetta GA 30004

Or, call Hansgrohe toll-free at (800) 334-0455.

In requesting warranty service, you will need to provide

1. The sales receipt or other evidence of the date and place of purchase.
2. A description of the problem.
3. Delivery of the product or the defective part, postage prepaid and carefully packed and insured, to Hansgrohe Inc. 1492 Bluegrass Lakes Parkway, Alpharetta, Georgia 30004, Attention: Technical Service, if required by Hansgrohe.

When warranty service is completed, any repaired or replacement product or part will be returned to you postage prepaid.

## EXCLUSIONS AND LIMITATIONS

**REPAIR OR REPLACEMENT (OR, IN LIMITED CIRCUMSTANCES, REFUND OF THE PURCHASE PRICE) AS PROVIDED UNDER THIS WARRANTY IS THE EXCLUSIVE REMEDY OF THE PURCHASER. HANSGROHE NEITHER ASSUMES NOR AUTHORIZES ANY PERSON TO CREATE FOR IT ANY OBLIGATION OR LIABILITY IN CONNECTION WITH THIS PRODUCT.**

**HANSGROHE SHALL NOT BE LIABLE TO PURCHASER OR ANY PERSON FOR ANY INCIDENTAL, SPECIAL, OR CONSEQUENTIAL DAMAGES, ARISING OUT OF BREACH OF THIS WARRANTY OR ANY IMPLIED WARRANTY (INCLUDING MERCHANTABILITY).**

Some States do not allow the exclusion or limitation of incidental or consequential damages, so the above limitation or exclusion may not apply to you.

This warranty gives you specific legal rights, and you may have other rights which vary from State to State.

You may be required by law to give us a reasonable opportunity to correct or cure any failure to comply before you can bring any action in court against us under the Magnuson-Moss Warranty Act.

## PRODUCT INSTRUCTIONS AND QUESTIONS

Upon purchase or prior to installation, please carefully inspect your Hansgrohe product for any damage or visible defect. Prior to installing, always carefully study the enclosed instructions on the proper installation and the care and maintenance of the product. If you have questions at any time about the use, installation, or performance of your Hansgrohe product, or this warranty, please call or write to us at the toll-free number and address printed above.

**hansgrohe**

AXOR | PHÄRO

Hansgrohe Inc. 1490 Bluegrass Lakes Parkway Alpharetta GA 30004  
Phone 770 360 9880 Internet [www.Hansgrohe-USA.com](http://www.Hansgrohe-USA.com)