

QTR / QTRE SERIES FAN / LIGHT / NIGHT LIGHTS MODELS QTR080L, QTR110L, QTRE080FLT, QTRE110FLT

QTR080L
QTR110L

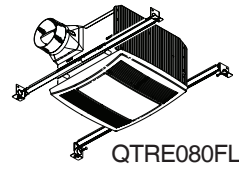
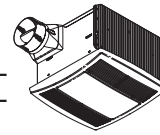

QTRE080FLT
QTRE110FLT

Ultra-quiet, high performance bath fan / light with a modern-styled grille.

FEATURES

BLOWER:

- Plug-in, permanently lubricated motor - engineered for continuous operation
- Dynamically balanced centrifugal blower wheel for quiet, efficient performance
- Low RPM for quiet operation
- Resilient anti-vibration motor mounts

HOUSING:

- Rugged, 26 gauge, galvanized steel construction
- Polymeric, 4" duct connector with tapered sleeve and no metallic clatter
- 7-5/8" height allows for 2" x 8" (nominal) joist installations
- Sturdy, easy, four-point mounting directly to joist
- Includes unique spacer (patent pending) for mounting to engineered "I" joists
- Includes hanger bars to position housing anywhere between 16" to 24"-on-center joists (Models QTRE080FLT & QTRE110FLT only)
- Two sets of mounting holes for hanger bars allow flush installation with bottom or top of drywall (Models QTRE080FLT & QTRE110FLT only)
- Can be mounted in ceilings up to 12/12 pitch (Models QTRE080FLT & QTRE110FLT only) or 7/12 pitch (Models QTR080L & QTR110L only)

GRILLE:

- Polymeric construction
- Innovative design - the result of extensive research with designers and consumers
- 42W fluorescent lamp* (Models QTRE080FLT & QTRE110FLT only) (bulb included)
- 100W incandescent lamp (Models QTR080L & QTR110L only) (bulb not included)
- 4W night light (all models) (bulb not included)
- Durable steel reflector with white enamel finish

BUILDER PACKS:

- Rough-in housing required - order Broan Model QTXR000HL (4 housings per carton)
 - Includes hanger bars to position housing anywhere between 16" to 24"-on-center joists (4 sets of hangers per carton)
 - Two sets of mounting holes for hanger bars allow flush installation with bottom or top of drywall

CONTROLS (Purchase separately):

- Refer to Broan's catalog for a complete line of accessories to effectively adapt these fans to your construction requirements

U.L. Listed for use over bathtubs and showers when connected to a GFCI protected branch circuit (ceiling mount only).

U.L. Listed for use in insulated ceilings (TYPE I.C.)

California Title 24 compliant (Models QTRE080FLT & QTRE110FLT only)

3-Year Warranty

TYPICAL SPECIFICATION

Ceiling Ventilator shall be Broan Model QTR080L (QTR110L) (QTRE080FLT) (QTRE110FLT).

Ceiling Ventilator shall have corrosion resistant galvanized steel housing with four-point mounting capability. It shall be ducted to a roof or wall cap using 4" round ductwork.

Blower assembly shall be removable, have a centrifugal-type blower wheel and a permanently lubricated motor designed for continuous operation and mounted with resilient anti-vibration mounts.

Non-metallic damper/duct connector shall be included.

Lamp shall be 42W fluorescent* (Models QTRE080FLT & QTRE110FLT only) or 100W incandescent (Models QTR080L & QTR110L only) with separate 4W night light.

Air delivery shall be no less than 80 (110) CFM and sound level no greater than 0.8 (1.0) (1.3) (1.5) Sones. All air and sound ratings shall be certified by HVI.

Ceiling ventilator shall be Energy Star® qualified and have an energy efficient permanent split capacitor motor (Models QTRE080FLT & QTRE110FLT only).

Ceiling Ventilator shall be U.L. Listed for use in insulated ceilings (Type I.C.) and for use over bathtubs and showers when connected to a GFCI protected branch circuit.



Models
QTRE080FLT &
QTRE110FLT only.

* Use only one of the following 42W fluorescent lamps:

G.E.	F42TBX827A4P/EOL or F42TBX830A4P/EOL
PHILIPS	PL-T 42W/827/4P/ALTO or PL-T 42W/830/4P/ALTO
SYLVANIA	CF42DT/E/IN/827 or CF42DT/E/IN/830
NEMA Type	CFTR42W/GX24q/827 or CFTR42W/GX24q/830
Broan	97016888

Broan-NuTone LLC, 926 West State Street, Hartford, WI 53027 (1-800-637-1453)

REFERENCE	QTY.	REMARKS	Project
			Location
			Architect
			Engineer
			Contractor
			Submitted by Date

PERFORMANCE RATINGS QTR / QTRE SERIES FAN / LIGHT / NIGHT LIGHTS

HVI PERFORMANCE

Model	Sones @0.1" Ps	CFM @0.1" Ps
QTR080L	1.0	80
QTR110L	1.5	110
QTRE080FLT	0.8	80
QTRE110FLT	1.3	110



HVI-2100 CERTIFIED RATINGS comply with new testing technologies and procedures prescribed by the Home Ventilating Institute, for off-the-shelf products, as they are available to consumers. Product performance is rated at 0.1 in. static pressure, based on tests conducted in AMCA's state-of-the-art test laboratory. Sones are a measure of humanly-perceived loudness, based on laboratory measurements.

AMPS

Model	Amps*
QTR080L	1.6
QTR110L	1.8
QTRE080FLT	1.0
QTRE110FLT	1.1

*Total connected load

WEIGHT

Model	Shipping Weight
QTR080L	13.8 lbs.
QTR110L	13.8 lbs.
QTRE080FLT	15.4 lbs.
QTRE110FLT	15.4 lbs.



Models QTRE080FLT
& QTRE110FLT only.

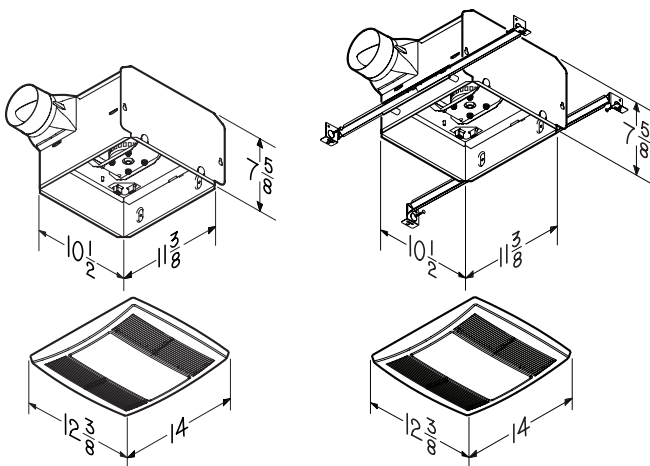

QTR080L
QTR110L

QTRE080FL
QTRE110FL

AIR FLOW PERFORMANCE

MODEL QTR080L

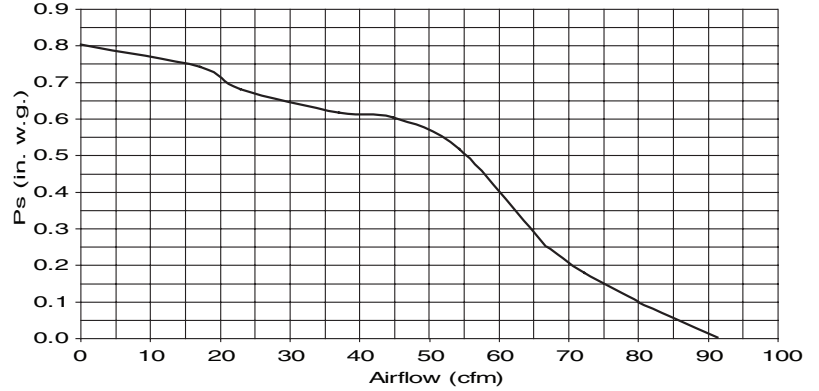

MODEL QTR110L

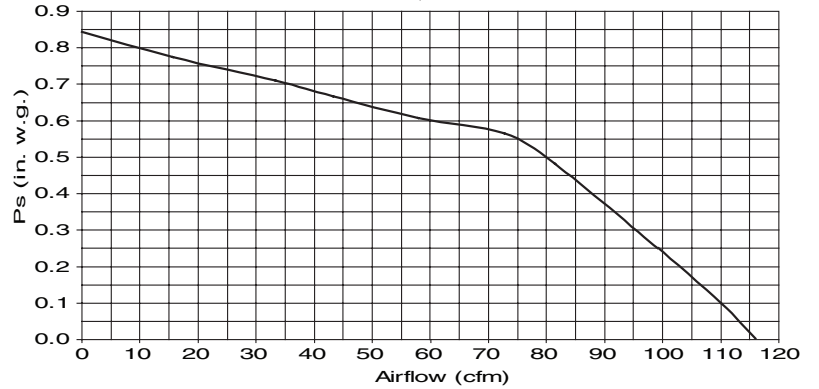

MODEL QTRE080FLT

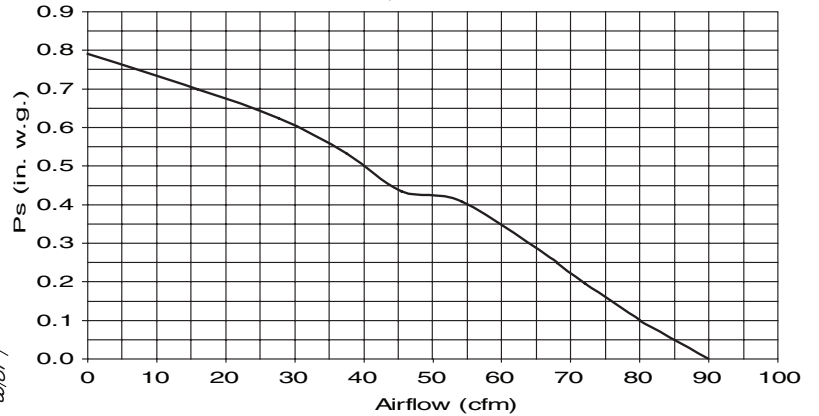

MODEL QTRE110FLT

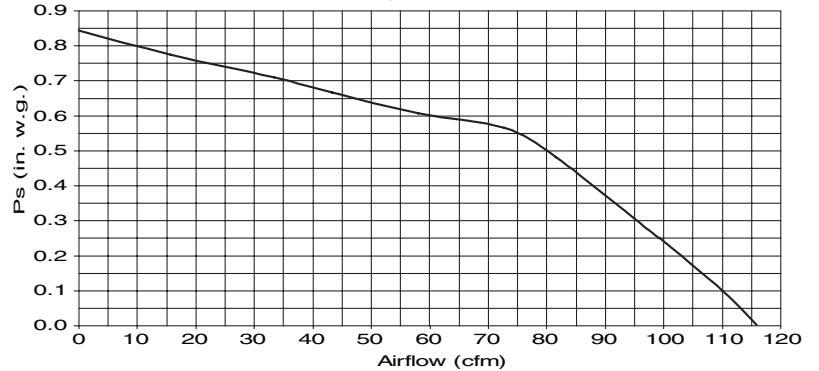

Broan-NuTone LLC, 926 West State Street, Hartford, Wisconsin 53027 (1-800-637-1453)