

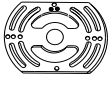









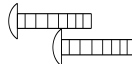

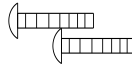

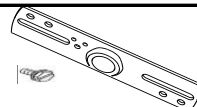

Fixture Name: Lancaster 6005-SF PW/RBZ/AB

This fixture assembled PO: \_\_\_\_\_ Date: \_\_\_\_\_

**Notice:** Please review the parts listing and check for all parts before assembling the fixture. If any parts are missing or damaged, please note on this sheet and contact the place of purchase to arrange for replacement parts.

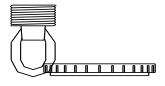
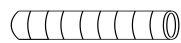
<b>PARTS LIST</b>		Company Name: _____ Co. Account #: _____ to be filled out by retailer	
Mounting strap (circular) 1ea 4" x 3"		Wire connectors 4ea P3 Orange	
Canopy 1ea 5" X 1"		Junction box screw 2ea 8/32" x 1"	
Chain 1ea 6ft x 3.8mm		Mounting screw 2ea 5/32" x 1"	
Chain connector 2ea 4 X 55mm		Hex nut 2ea 3/8 x 3mm	
Mounting strap w/ ground screw 1ea 3/4" X 4"		Top cap 1ea 108 x 37mm	
Bottom cap 1ea 70 x 23mm		Flat washer 1ea 1" x 3mm	
Spring washer 1ea 15 x 3mm		Threaded rod 1ea 3/8 x 145	
Deco nut 2ea 9 x 9.5mm		Top loop 1ea 3/8 x 66mm	
Canopy loop with Collar 1ea 3/8 x 30mm x 5mm		Nipple 1ea 3/8 x 45mm	
Screw 2ea 5/32" x 8mm		Finial 1ea 3/8 x 40mm	
Check ring 1ea 18 x 3mm			
Part Needed _____		Quantity _____	
Part Needed _____		Quantity _____	
Reason why _____	(missing, scratched, broken glass, bent, bad finish)		
Comments _____			

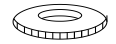
## FIXTURE ASSEMBLY INSTRUCTIONS

**Read and review installation instruction sheet before assembling the fixture.**

### ASSEMBLING THE FIXTURE as Semi-flush (Fig. 1)

1. Thread the threaded rod/nipple (G) onto the socket assembly coupler. Secure with a hex nut.
2. Install the light bulbs in accordance with the fixture's specifications.  
(DO NOT EXCEED MAXIMUM WATTAGE RATING)
3. Slide the Glass shade (H) and Flat Washer (I) over the Nipple (G). Secure in place with the Hex Nut (J). Slide the Bottom Cap (K) over the Nipple (G). Secure in place with the Finial (L).

**NOTE: INSTALL THE GLASS ASSEMBLY AFTER THE FIXTURE IS HUNG.**

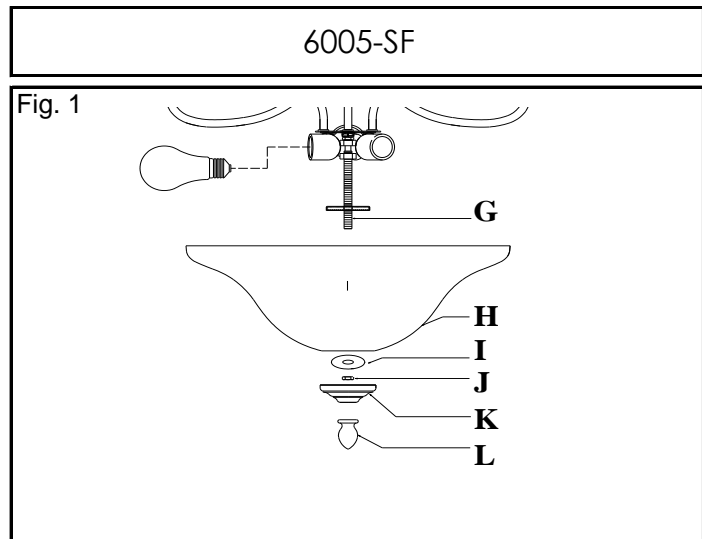

# PARTS & ASSEMBLY SHEET

Fixture Name: Lancaster 6005-SF PW/RBZ/AB

## ASSEMBLING THE FIXTURE as Chain hung (Fig. 2)

1. Remove the circular strap from top of fixture and replace the long mounting screws with two short Screws (Z) to hold the Deco Nuts (E) in place on the bottom half of fixture Top Cap (F).
2. Thread the Threaded Rod (X) to fixture coupler in bottom half of Top Cap (F).
3. Slide the Top Cap (Y) over wires and secure with Check Ring.
4. Feed the fixture wires through the Top Loop (W) then screw the Top Loop (W) to the Threaded Rod (X) until tight.
5. By measuring, determine correct number of links needed for proper hanging height. Use a pair of pliers to open a link of the Chain (U), then remove the excess Chain (U) and discard it.
6. Use a Chain Connector (V) to attach one end of the chain to the Top Loop (W) and close the chain connector.
7. Feed the fixture wires through the chain (every three links) and pull the wires until taut.
8. Slip Canopy Loop (R) and Collar (S) over the chain. Then do the same with the Canopy (G).
9. When ready to complete the installation, use the remaining chain connector to attach the loose end of the chain to the Canopy Loop (R). Close the chain connector.
10. Make sure the weight of the chandelier will be supported by the chain - not the electrical wire.

Note: Complete these remaining steps after the fixture is hung.

11. Thread the threaded rod/nipple (G) onto the socket assembly coupler. Secure with a hex nut.
12. Install the light bulbs in accordance with the fixture's specifications.
13. Slide the Glass Shade (H) and Flat Washer (I) over the Nipple (G). Secure in place with the Hex Nut (J). Slide the Bottom Cap (K) over the Nipple (G). Secure in place with the Finial (L).

(DO NOT EXCEED MAXIMUM WATTAGE RATING)

Fig. 2

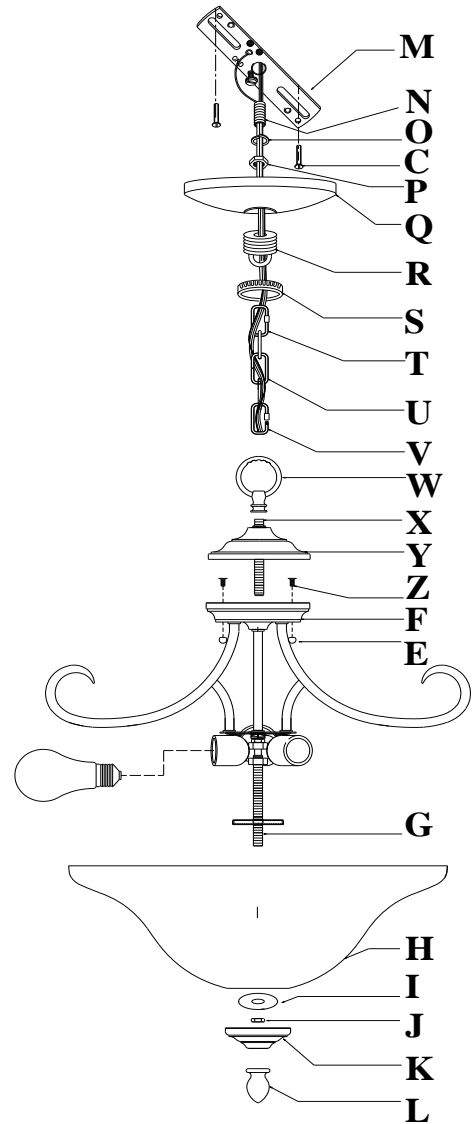
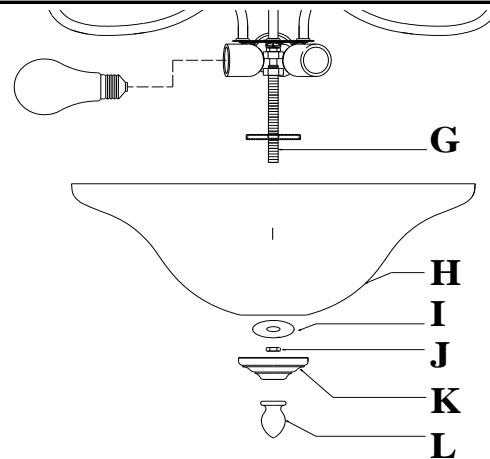

Fig. 3



For Customer Service, contact the place of purchase to arrange for replacement parts.

## WARNING ! SHUT OFF POWER AT FUSE OR CIRCUIT BREAKER.

### HANGING THE FIXTURE as Semi-flush (Fig. 1)

1. Carefully remove the new fixture from the carton and the yellow bag that holds all your parts. Check that all parts are included as shown in the illustration and parts list.
2. Shut off power at the circuit breaker and remove the old fixture from ceiling, including the old mounting strap.
3. The Circular Strap (B) contains several pairs of threaded holes. Find the pair of holes that matches the hole spacing in your fixture Canopy (F). Thread the two Mounting Screws (A) halfway into the Mounting Strap (B) facing down. Secure in place with hex nuts. These will have their threaded ends protrude through the two holes in the fixture canopy (F).
4. Place the Mounting Strap (B) over the junction box.
5. Attach the Mounting Strap (B) to the junction box using the two Mounting Screws (C). Tighten the screws (C) securely with screwdriver.

### CONNECTING THE WIRES (Fig. 2)

6. Attach the power supply wires to the fixture lead wires by connecting BLACK to BLACK (or SMOOTH) and WHITE to WHITE (or RIBBED).  
NOTE: Twist the wires together in the same direction you twist the wire connector onto the wires.
7. Attach the GROUND wire (GREEN or COPPER) from the junction box and the fixture ground wire to the green ground screw on the Mounting Bracket (B). Or, connect both wires together using a wire connector.
8. Tuck these wire connections neatly into the junction box.

### FINISHING THE INSALLATION (Fig. 3)

9. Place the fixture's Canopy (F) over the Mounting Strap (B) and over the Mounting Screws (A). Adjust the fixture canopy until the Mounting Screws (A) protrude out from the canopy. Secure the fixture against the ceiling by threading the Decorative Nuts (E) on until tight.
10. Install the light bulbs and glass shade according to the fixture assembly sheet.

YOUR INSTALLATION IS NOW COMPLETE. RETURN POWER TO THE JUNCTION BOX AND TEST THE FIXTURE.

Fig. 1

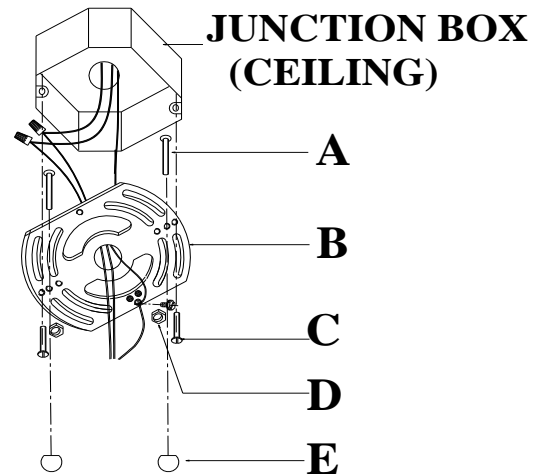

Fig. 2

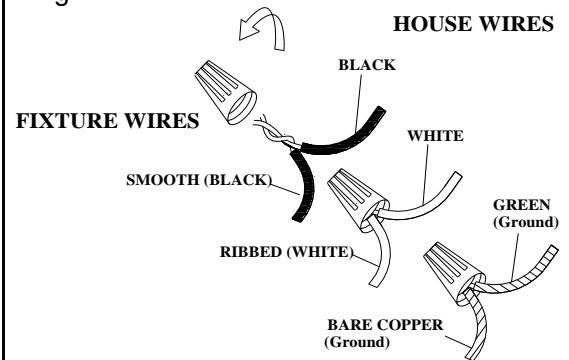
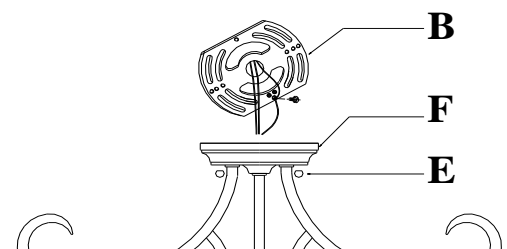

Fig. 3



## WARNING ! SHUT OFF POWER AT FUSE OR CIRCUIT BREAKER.

### HANGING THE FIXTURE as Chain Hung (Fig. 1)

- Carefully remove the new fixture from the carton and the yellow bag that holds all parts. Check that all parts are included as shown in the illustration and parts list.
- Shut off the power at the circuit breaker and remove old fixture from ceiling, including the old mounting strap.
- Thread Nipple (C) into Canopy Loop (F) until snug.
- Thread other end of the Nipple (C) with Canopy Loop (F) attached into Mounting Strap (D).
- Place Lock Washer (B) over end of Nipple (C) protruding through Mounting Strap (D). Thread Hex Nuts (A) onto Nipple (C) until tight.
- Take this mounting strap assembly and mount to ceiling junction box with junction box Screws (E). Tighten screws securely with screwdriver.
- Unscrew the Canopy loop collar (H) from the Canopy Loop (F). Take the canopy and pass over the Canopy Loop (F). Approximately half of the canopy loop exterior threads should be exposed. Adjust until desired height is reached.  
\*The Canopy loop collar should fit snugly on the Canopy loop after the canopy is installed. Remove Canopy and Canopy lock collar.
- Assemble the fixture and have an assistant support the weight of the fixture while you complete the wiring connections.
- Thread the fixture wires and ground wire of the assembled fixture through the canopy loop and nipple, and into the outlet box.

### CONNECTING THE WIRES (Fig. 2)

- Attach the power supply wires to the fixture lead wires by connecting BLACK to BLACK (or SMOOTH) and WHITE to WHITE (or RIBBED).
- NOTE: Twist the wires together in the same direction you twist the wire connector onto the wires.
- Attach the GROUND wire (GREEN or COPPER) from the Junction Box and the fixture ground wire to the green ground screw on the Mounting Bracket (D). Or, connect both wires together using a wire connector.
  - Tuck these wire connections neatly into the Junction Box.
  - Raise Canopy (G) to the ceiling and secure in place by tightening the Canopy Loop Collar(H) into the Canopy Loop (F).
  - Install the light bulbs and glass shade according to the fixture assembly sheet.

Fig. 1

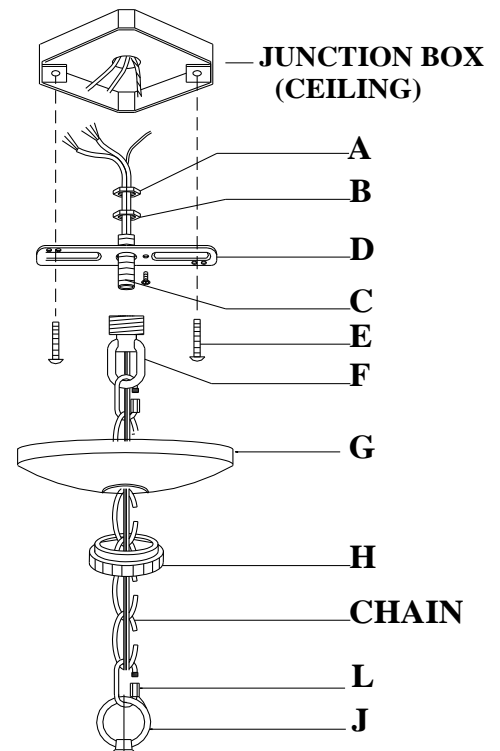
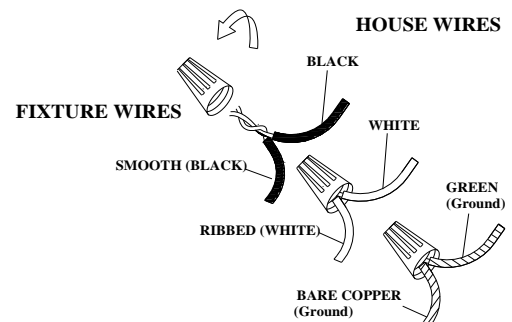

Fig. 2



**YOUR INSTALLATION IS NOW COMPLETE.  
RETURN POWER TO THE JUNCTION BOX  
AND TEST THE FIXTURE.**