

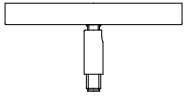

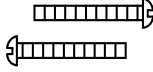
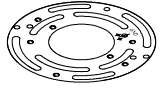
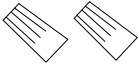

Fixture Name: Celesse 7071-5 CH

This fixture assembled PO: _____ Date: _____

Notice: Please review the parts listing and check for all parts before assembling the fixture. If any parts are missing or damaged, please note on this sheet and contact the place of purchase to arrange for replacement parts.

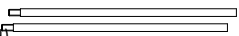
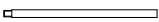
PARTS LIST		Company Name: _____ Co. Account #: _____ to be filled out by retailer	
Canopy 1ea Ø6"*H3/4" 	Mounting Screws 2ea 8#32-IP*1" 	Mounting Strap 1ea Ø4"*H2mm 	
Wire connectors 3ea P3 Orange 	Mounting Screws 2ea 5/32-IP*1-1/2" 	Hex Nut 2ea 5/32-IP*H3mm 	
Rod (ROD-7071 CH) 3ea Ø15.5*H12" 	Rod 1ea Ø15.5*H6" 	Deco Nut 2ea 5/32-IP*H10mm 	
Part Needed _____		Quantity _____	
Part Needed _____		Quantity _____	
Reason why (missing, scratched, broken glass, bent, bad finish)			
Comments _____			

FIXTURE ASSEMBLY INSTRUCTIONS

Read and review installation instruction sheet before assembling the fixture.

- By measuring determine correct number of rods needed for proper hanging height. There are 3 optional 12" rods included. To shorten the fixture slide the excess 12" rods off the wire. To lengthen the fixture thread the additional rods onto the wire.
 - Pull the fixture's wire through the Rods until taut.
 - Thread Rod (G) into Frame (H) until tight. Repeat for any additional rods.
 - Feed the fixture wires through the Swivel Joint (F) and pull the wires until taut. Then screw the Rod (G) to the Swivel Joint until tight.
 - Thread the glass crystal strands (X,Y,Z) onto the fixture in the following order: X,Y,Z,Y,X by inserting the metal prongs at the top through the hole in the bar and folding each side down into a "T" shape. *see the inset
- * You may now install the fixture
- Place the Shade (J) over the Threaded Socket (I) and secure by threading the Socket Ring (K) to Threaded Socket (I) until tight.
 - Install the light bulbs in accordance with the fixture's specifications.

(DO NOT EXCEED MAXIMUM WATTAGE RATING)

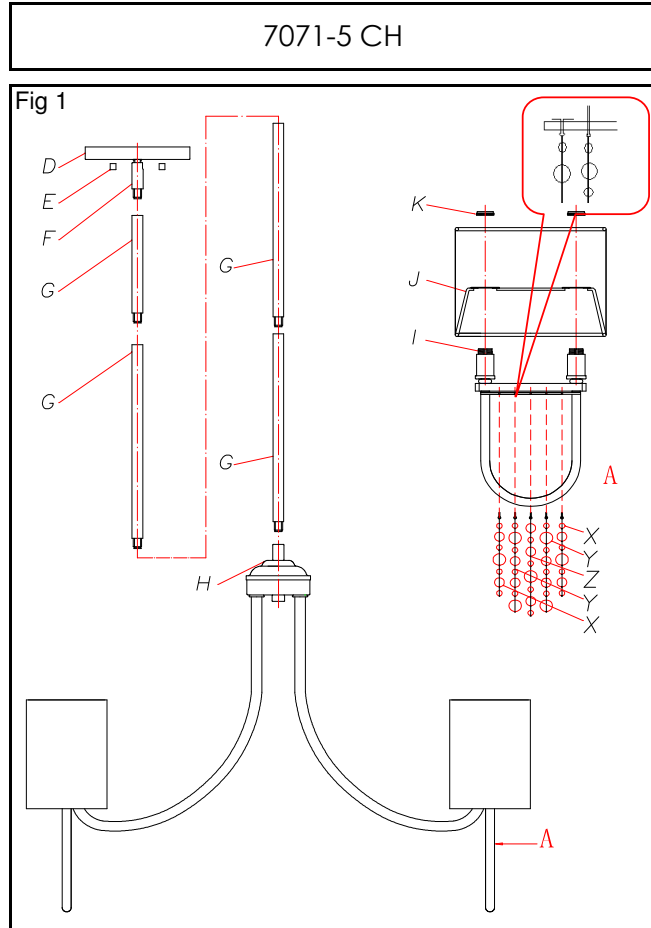

For Customer Service, contact the place of purchase to arrange for replacement parts.

Fixture Name: Celesse 7071-M3, -5, -8, M1L CH

For Rod hung Pendant Light Fixture

WARNING ! SHUT OFF POWER AT FUSE OR CIRCUIT BREAKER.

HANGING THE FIXTURE as Semi flush (Fig. 1)

1. Carefully remove the new fixture from the carton and the yellow bag that holds all your parts. Check that all parts are included as shown in the illustration and parts list.
2. Shut off power at the circuit breaker and remove the old fixture from ceiling, including the old mounting strap.
3. The Mounting bracket (C) contains several pairs of threaded holes, find the pair of holes that match the hole spacing in your fixture Back Plate (N) and thread the two Mounting Screws (B) half way into the Mounting Strap (C) facing down, these will have their threaded ends protrude through the two holes in the fixture canopy(N).
4. Place the Mounting Strap (C) over the junction box
5. Attach the Mounting Strap (C) to the Junction Box using the two mounting screws (E). Tighten the screws (E) securely with screw driver.

CONNECTING THE WIRES (Fig. 2)

6. Attach the power supply wires to the fixture lead wires by connecting BLACK to BLACK (or SMOOTH) and WHITE to WHITE (or RIBBED).
 7. Attach the GROUND wire(GREEN or COPPER) from the Junction Box and the fixture Ground wire to the green Ground Screw on the Mounting Bracket (C) or connect both wires together using the correct size of wire connectors.
- NOTE: Twist the wires together in the same direction you twist the wire connector onto the wires.
8. Tuck these wire connections neatly into the Junction Box.

FINISHING THE INSALLATION (Fig. 3)

9. Place the fixture's canopy over the Mounting bracket (C), adjust the canopy (N) until the Mounting Screws (B) protrude out from the canopy (N) and secure by threading the Decorative nuts (O) on until tight.
10. Install the light bulbs and shades as per the fixture assembly sheet.

YOUR INSTALLATION IS NOW COMPLETE. RETURN POWER TO THE JUNCTION BOX AND TEST THE FIXTURE.

