



GOLDEN
Elegant lighting for everyday living

PARTS & ASSEMBLY SHEET







Fixture Name: **Hidalgo 1051-3P SBZ**

This fixture assembled PO: _____ Date: _____

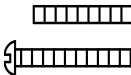
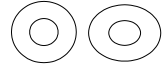
Notice: Please review the parts listing and check for all parts before assembling the fixture. If any parts are missing or damaged, please note on this sheet and contact the place of purchase to arrange for replacement parts.

PARTS LIST

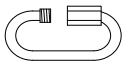
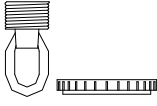
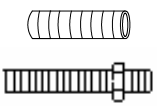
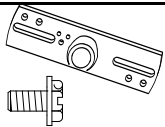
Company Name: _____ Co. Account #: _____
to be filled out by retailer

Canopy	 1ea	Mounting Screws	2ea 	Metal Washer, Rubber washer and Spacer	1ea 
Chain	6ft 	Wire connectors	3ea 	Bottom cap	1ea 
Chain connector	2ea 	Canopy loop and Canopy loop collar	1ea 	Nipple	2ea 
Mounting Strap Green screws	1set 	Hex Nut	3ea 	Finial	1ea 

Part Needed	_____	Quantity	_____
Part Needed	_____	Quantity	_____
Reason why	(missing, scratched, broken glass, bent, bad finish)		
Comments	_____		

FIXTURE ASSEMBLY INSTRUCTIONS

Read and review installation instruction sheet before assembling the fixture.

1. This fixture is packed with the arms closed. Gently spread the arms (C) until evenly spaced.
2. Feed the fixture wires through the Top loop (A) and pull the wires until taut.
3. Then screw the Top Loop (A) to the top of Frame coupler (B) until tight.

NOTE: INSTALL THE GLASS ASSEMBLY AFTER THE FIXTURE IS HUNG.

1051-3P SBZ

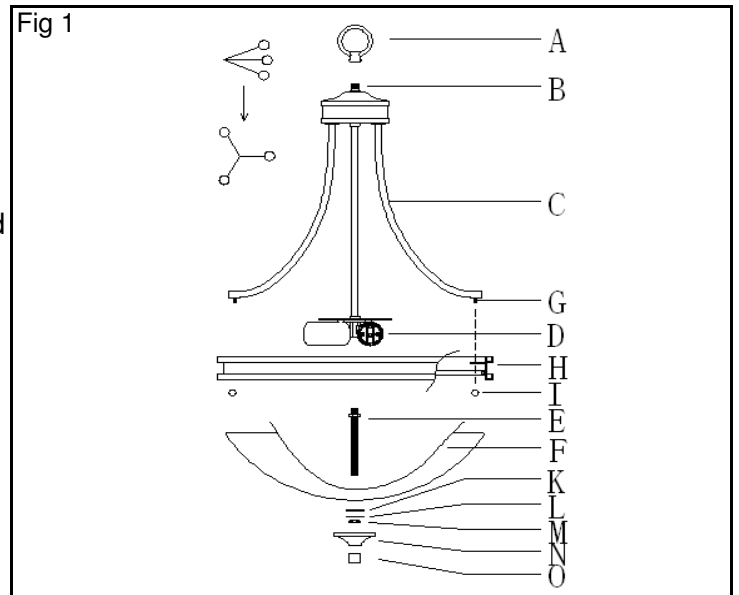

For Customer Service, contact the place of purchase to arrange for replacement parts.

PARTS & ASSEMBLY SHEET

Fixture Name: Hidalgo 1051-3P SBZ

4. Slide Center Ring (H) up to the Arms (C) and make the screw(G) through the hole of the Steel clip(J) ,secure with Ball nut(I). (see Fig2)

Fig 2

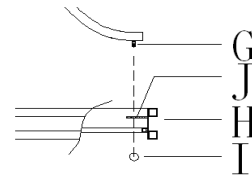

5. By measuring determine correct number of links needed for proper hanging height. Use a pair of pliers to open one link of the Chain (C2) then remove the excess Chain (C2) and discard it.

6. Use one chain connector (E2) to attach one end of the chain to the Top loop (D2) and close the chain connector.

7. Feed the fixture wires through the Chain (every three links) and pull the wires until taut.

8. Slip Canopy loop collar (B2) over the chain, then do the same with the canopy (F2).

9. When ready to complete the installation Use the other chain connector and attach the other end of the chain to the canopy loop (A2) and close the chain connector.

10. Make sure the weight of the chandelier is supported by the chain-not the electrical wire.

* You may now install the fixture.

Fig 3

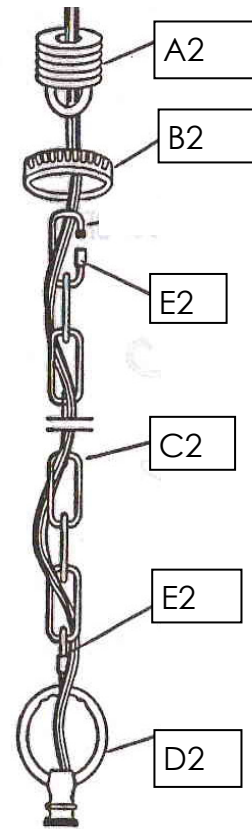

NOTE: Finish installing the glass after the fixture is hung.

11. Thread the Nipple (E) into the Socket assembly (D), lock into position by the tightening hex nut.

12. Install the light bulbs in accordance with the fixture's specifications.

13. Slide the Glass shade (F), Rubber washer (K), Metal washer (L) over the Nipple (E) secure them by the Hex Nut (M).

14. Slide the Bottom Cap (N) over the Nipple (E), screw the Finial (O) onto the Nipple (E) until tight. (DO NOT EXCEED THE MAXIMUM WATTAGE RATING)

Fig 4

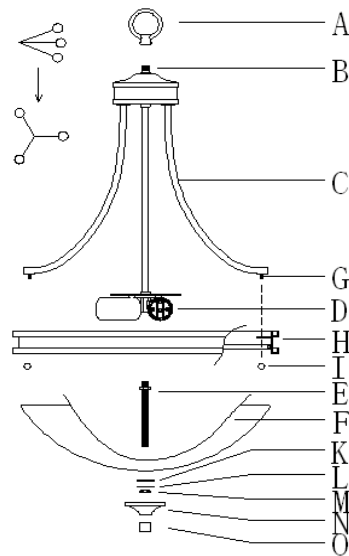

WARNING ! SHUT OFF POWER AT FUSE OR CIRCUIT BREAKER.

HANGING THE FIXTURE (Fig.1)

- Carefully remove the new fixture from the carton and the yellow bag that holds all parts. Check that all parts are included as shown in the illustration and parts list.
- Shut off the power at the circuit breaker and remove old fixture from ceiling, including the old mounting strap.
- Thread Nipple (C) into Canopy Loop (F) until snug.
- Thread other end of the Nipple (C) with Canopy Loop attached into Mounting Strap (D).
- Place Lock Washer (B) over end of Nipple (C) protruding through Mounting Strap (D) and thread Hex Nuts (A) onto Nipple until tight.
- Take this mounting strap assembly and mount to ceiling junction box with junction box Screws (E). Tighten screw securely with screw driver.
- Unscrew the Canopy loop collar (H) from the Canopy loop. Take the canopy and pass over the Canopy loop. approximately one half of the canopy loop exterior threads should be exposed. Adjust until desired height is reached. *the Canopy loop collar should fit snugly on the Canopy loop after the canopy is installed. Remove Canopy and Canopy loop collar.
- Assemble the fixture and have an assistant or secure support hold the weight of the fixture while you complete the wiring connections.
- Thread the fixture wires and ground wire of the assembled fixture through the canopy loop and nipple and into the outlet box.

CONNECTING THE WIRES (Fig 2)

- Attach the power supply wires to the fixture lead wires by connecting BLACK to BLACK (or SMOOTH) and WHITE to WHITE (or RIBBED).
 - Attach the GROUND wire(GREEN or COPPER) from the Junction Box and the fixture Ground wire to the green Ground Screw on the Mounting Bracket (D) or connect both wires together using the correct size of wire connectors.
- NOTE: Twist the wires together in the same direction you twist the wire connector onto the wires.
- Tuck these wire connections neatly into the Junction Box.

FINISHING THE INSTALLATION

- Raise Canopy (G) to the ceiling and secure in place by tightening the Canopy loop collar (H) into the Canopy Loop (F)
- Install the light bulbs and glass shade as per the fixture assembly sheet.

Fig. 1

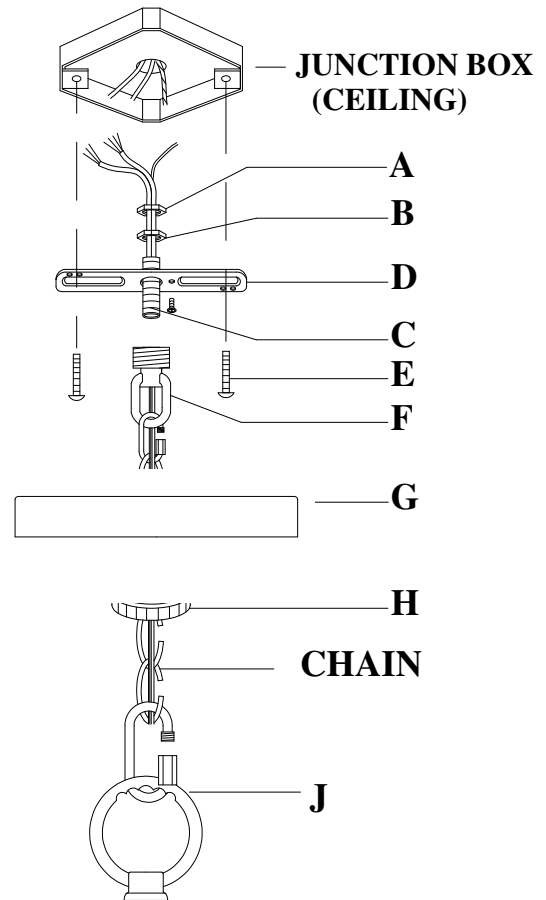
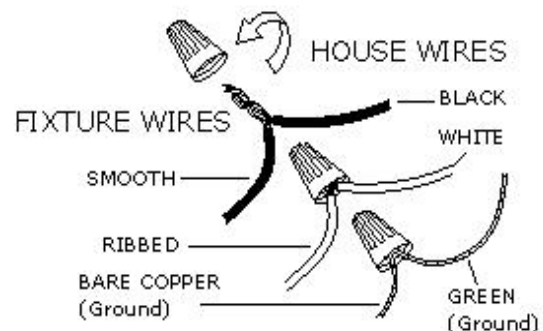

Fig. 2



YOUR INSTALLATION IS NOW COMPLETE.
RETURN POWER TO THE JUNCTION BOX AND
TEST THE FIXTURE.