

Family: Hathaway | Item No. 3222 AN/OB

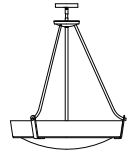

▼ start here

**Drawing 1 - Fixture Assembly**

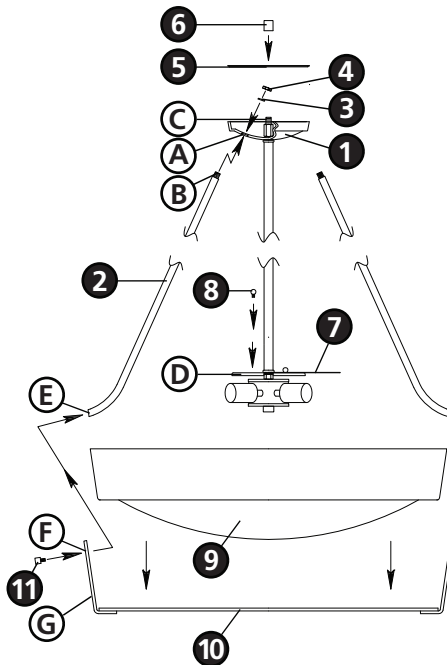

**1**

1. Find a clear area in which you can work.
2. Unpack fixture and glass from carton.
3. Carefully review instructions prior to assembly.

**\*\*\* The construction of this fixture will be accomplished by first assembling the main body of the fixture, determining the length of stem required, mounting the mounting strap to the junction box, making all necessary electrical connections, hanging the fixture from the ceiling, and then installing the glass. \* It is recommended that assistance be available when installing this fixture**

**2**

1. Slip threaded end (B) of upright (2) into recessed hole (A) of canopy (1) - see **Drawing 1**.
2. Slip lockwasher (3) onto threaded end (B) of upright (2). Then thread on hex nut (4) - do not tighten at this time.
3. Repeat steps 1 and 2 for remaining uprights.
4. Slip cap (5) along wire and place on top of canopy (1).
5. Slip coupler (6) along wire and thread onto threaded tube (C) and tighten.
6. The diffuser (7) is attached by first removing the ball knob studs (8) from the cluster plate (D).
7. Place diffuser (7) onto top of cluster plate (D) and line up the holes.
8. Thread ball knob studs (7) back into cluster plate (D) to secure diffuser. Repeat with opposite diffuser panel.
9. Please refer to the hanging instruction sheet (I.S. 19) provided to hang this fixture. Then refer back to this sheet to complete fixture assembly

**3**

1. To install glass, set glass (9) into ring (10) - see **Drawing 1**.
2. Line up hole (F) in ring upright (G) with hole (E) in end of upright (2).
3. Slip threaded stud (11) through hole (F) in ring upright (G) and thread into hole (E) of upright (2).
4. Repeat steps 2 and 3 for the remaining uprights.
5. tighten all hex nuts and ball knob studs at this time.
6. Fixture can now be lamped accordingly.

Note: Maximum wattage for 3222 fixture is 100 watts per bulb.

4.8.10